



Pulse Secure Virtual Traffic Manager: User's Guide

21.2

Copyright Notice

This document is provided strictly as a guide. No guarantees can be provided or expected. This document contains the confidential information and/or proprietary property of Ivanti, Inc. and its affiliates (referred to collectively as "Ivanti") and may not be disclosed or copied without prior written consent of Ivanti.

Ivanti retains the right to make changes to this document or related product specifications and descriptions, at any time, without notice. Ivanti makes no warranty for the use of this document and assumes no responsibility for any errors that can appear in the document nor does it make a commitment to update the information contained herein. For the most current product information, please visit www.ivanti.com.

Copyright © 2021, Ivanti. All rights reserved.

Protected by patents, see <https://www.ivanti.com/patents>.

Contents

| | |
|--|-----------|
| Preface | 10 |
| Document conventions | 10 |
| Requesting Technical Support | 11 |
| Traffic Manager Overview | 13 |
| Introducing the Traffic Manager | 13 |
| Traffic Manager Product Variants | 14 |
| Chapter Outline | 17 |
| Network Layouts | 22 |
| Essentials of Network Configuration | 22 |
| Dedicated Management Network | 23 |
| Sizing Your Cluster | 24 |
| IP Transparency | 26 |
| Traffic IP Addresses and Traffic IP Groups | 28 |
| Introduction to IPv6 | 40 |
| Initial Configuration | 43 |
| Architecture Concepts | 43 |
| Managing Your First Service | 45 |
| Creating a Cluster | 47 |
| Virtual Servers | 52 |
| Introduction | 52 |
| Applying Rules | 54 |
| SSL Decryption | 55 |
| Service Protection Classes | 57 |
| Bandwidth Management Classes | 57 |
| Service Level Monitoring Classes | 58 |
| HTTP Content Caching | 58 |
| Web Accelerator | 59 |
| HTTP Content Compression | 59 |
| Connection Analytics | 60 |
| Request Logging | 64 |
| Protocol Settings | 65 |
| Pools | 73 |
| Introduction | 73 |
| Load Balancing | 74 |
| Session Persistence | 77 |
| Bandwidth Management | 77 |
| Health Monitoring | 78 |
| SSL Encryption | 78 |
| Protocol Settings | 79 |
| Limiting Requests to a Pool | 79 |
| Back-End Fault Tolerance | 83 |
| Draining, Disabling, or Removing a Node | 86 |

| | |
|---|------------|
| Autoscaling | 88 |
| DNS-Derived Autoscaling | 97 |
| Service Discovery | 98 |
| Traffic IP Groups and Fault Tolerance | 104 |
| Fault Tolerance | 104 |
| Choosing Traffic IP Addresses | 105 |
| Creating a Traffic IP Group | 106 |
| Interface-to-Subnet Mapping (Traffic IP Networks) | 109 |
| Configuring Fault-Tolerance | 110 |
| Failover | 114 |
| Debugging and Monitoring Fault Tolerance Activity | 116 |
| Configuring BGP Connectivity | 117 |
| Configuring OSPFv2 Connectivity | 119 |
| Key Features in the Traffic Manager Administration Interface | 122 |
| The Home Page | 122 |
| Services > Configuration Summary | 123 |
| Catalogs | 124 |
| License Management | 125 |
| System > Global Settings | 129 |
| System > Backups | 131 |
| Activity Monitoring | 138 |
| Exporting Analytics to a Remote Service | 146 |
| Cloud Credentials | 156 |
| The Pulse Secure Virtual Web Application Firewall | 158 |
| TrafficScript Rules | 166 |
| Overview | 166 |
| Using a Rule on the Traffic Manager | 170 |
| Example Rules | 175 |
| Providing Authentication for your Services | 180 |
| Overview | 180 |
| Using TrafficScript Rules with Remote LDAP Authenticators | 180 |
| Configuring the Traffic Manager as a SAML Service Provider | 184 |
| Java Extensions | 192 |
| Introduction to Java | 192 |
| Invoking a Java Extension | 192 |
| Configuring the Traffic Manager to Use Java | 193 |
| Protocol Support | 196 |
| Overview | 196 |
| Basic TCP Protocols | 196 |
| HTTP | 199 |
| SSL | 201 |
| SMTP (Simple Mail Transport Protocol) | 204 |
| FTP | 205 |
| Real-Time Streaming Protocol | 209 |

| | |
|---|------------|
| Session Initiation Protocol | 211 |
| Proxy Protocol | 220 |
| Session Persistence | 221 |
| What Is Session Persistence? | 221 |
| Configuring Session Persistence | 222 |
| Session Persistence with UDP protocols | 233 |
| Examples | 234 |
| SSL Encryption | 235 |
| Overview of SSL | 235 |
| SSL Features in the Traffic Manager | 237 |
| SSL Decryption Wizard | 238 |
| Configuring SSL Certificates | 238 |
| Managing Certificate Authority Certificates and CRL Files | 244 |
| SSL Decryption | 245 |
| SSL Encryption | 268 |
| Preserving IP Addresses with SSL Forwarding | 269 |
| Use of SSL Cryptographic Devices | 270 |
| Health Monitoring | 278 |
| Which Nodes Are Monitored? | 278 |
| Passive Health Monitoring | 279 |
| Overview of Health Monitors | 281 |
| The Monitors Catalog | 282 |
| Using Health Monitors | 287 |
| External Program Monitors | 287 |
| Service Protection | 290 |
| Classes of Risk | 290 |
| Protection Features | 291 |
| Enabling Service Protection | 293 |
| Adding a Service Protection Class | 293 |
| Applying a Service Protection Class to a Virtual Server | 297 |
| Service Protection Performance | 298 |
| Bandwidth Management | 299 |
| What Is Bandwidth Management? | 299 |
| Configuring Bandwidth Management | 300 |
| Request Rate Shaping | 303 |
| What Is Request Rate Shaping? | 303 |
| Configuring a Request Rate Shaping Class (Rate Class) | 304 |
| Using a Rate Class | 304 |
| More Fine-Grained Rate Shaping | 306 |
| Graphing Request Rate Shaping | 307 |
| Service Level Monitoring | 309 |
| Introducing Service Level Monitoring | 309 |
| Configuring a Service Level Monitoring Class (SLM Class) | 309 |
| Applying an SLM Class to a Virtual Server | 311 |

| | |
|---|------------|
| Applying SLM Classes from TrafficScript | 311 |
| SLM Class TrafficScript Examples | 311 |
| Graphing SLM Class Conformance Rates | 312 |
| Content Caching | 314 |
| Introduction | 314 |
| Configuring Content Caching | 314 |
| Caching Policy | 319 |
| Controlling Content Caching Using TrafficScript | 321 |
| Forcing Stale Content out of the Cache | 323 |
| Using Pulse Secure Web Accelerator | 325 |
| Introduction | 325 |
| Modes of Operation | 325 |
| Configuring Web Content Accelerator for Your Services | 326 |
| Measuring Web Content Accelerator Changes | 333 |
| Understanding Custom Acceleration Profiles | 335 |
| Understanding Optimization Techniques | 343 |
| Troubleshooting Web Content Accelerator | 351 |
| Event Handling and Alerts | 361 |
| Overview | 361 |
| Event Types | 362 |
| Actions | 364 |
| Configuring an Event Handler | 365 |
| Custom Actions | 366 |
| Raising Events from TrafficScript or Java Extensions | 369 |
| Configuring System Level Settings | 372 |
| Network Configuration | 372 |
| Time and Date Configuration | 383 |
| Remote Login to the Traffic Manager | 384 |
| Entering Custom Kernel Parameters | 384 |
| Kernel Page Table Isolation | 385 |
| System Security | 387 |
| Firewall and Operating System Settings | 387 |
| Network Design | 389 |
| UNIX User Permissions | 390 |
| File System Security | 390 |
| Operating System Settings | 391 |
| Administration System Security | 392 |
| Basic Administration Server Settings | 392 |
| User Management | 399 |
| Login Security and Behavior | 409 |
| The Login Information Banner | 410 |
| The Event and Audit Logs | 410 |
| General Security Considerations | 411 |
| The Traffic Manager Control API | 413 |

| | |
|---|------------|
| Introducing the Traffic Manager Control API | 413 |
| Example: Listing Running Virtual Servers | 414 |
| Command Line Interface | 417 |
| Introduction | 417 |
| Accessing the CLI | 417 |
| Commands | 419 |
| Scripting the CLI | 427 |
| Granular Configuration Import/Export with zconf | 429 |
| Introduction | 429 |
| Using zconf | 429 |
| Exporting a Complete Backup | 430 |
| Configuration Listings | 431 |
| Partial Imports | 431 |
| Multi-Site Cluster Management | 432 |
| Introduction | 432 |
| Activation and Deactivation | 433 |
| Key Concepts | 433 |
| Deployment Scenarios | 434 |
| Configuration | 437 |
| The Traffic Manager DNS Server | 442 |
| DNS Primer | 442 |
| Supported DNS Features | 447 |
| Configuring the DNS Server | 451 |
| Global Load Balancing | 455 |
| Introduction and Prerequisites | 455 |
| About Global Server Load Balancing | 455 |
| Deployment Planning | 457 |
| Components of a Traffic Manager GLB Deployment | 462 |
| Configuring GLB | 465 |
| Traffic Visualization | 475 |
| Testing DNS with DIG | 476 |
| Using a GeolIP Database | 477 |
| FIPS Validation in the Traffic Manager | 481 |
| Introduction to FIPS | 481 |
| FIPS Mode | 481 |
| Deploying FIPS Mode | 484 |
| Kerberos Constrained Delegation Support | 492 |
| The Kerberos Protocol | 492 |
| Kerberos Protocol Transition and Constrained Delegation | 492 |
| Rationale for Using Kerberos | 493 |
| Configuring Kerberos on the Traffic Manager | 493 |
| Load-Balancing a Pulse Connect Secure Service | 498 |
| Overview of a PCS Load Balancing Configuration | 498 |
| Topology of a PCS Load Balancing Configuration | 499 |

| | |
|--|------------|
| Running the Load-balance a Pulse Connect Secure Wizard | 500 |
| Using the Traffic Manager to Provide Optimal Gateway Selection | 508 |
| Troubleshooting | 517 |
| Tools and Techniques | 517 |
| Diagnosis and Event Logging | 517 |
| Monitoring Requests and Responses | 518 |
| Detailed Debugging of Connections | 520 |
| Testing Individual Nodes | 522 |
| Understanding Your Configuration | 523 |
| Troubleshooting Tips | 523 |
| Common Problems | 525 |
| Getting Help | 528 |
| Glossary | 530 |
| Software License Acknowledgments | 538 |
| License for the Berkeley DB Code (Version 1.85) | 538 |
| RSA PKCS11 | 539 |
| License for OpenLDAP | 539 |
| PCRE2 License | 540 |
| License for Yahoo! UI Library | 543 |
| License for ssleay Cryptographic Library | 543 |
| License for libxml2 and libxslt | 544 |
| License for the Java Servlet API | 546 |
| License for the Expat XML Parser | 547 |
| License for MooTools | 547 |
| Licenses for OpenLayers | 548 |
| License for rsync | 549 |
| License for Antlr and libantlr | 551 |
| License for es3-grammar | 552 |
| License for jsoncpp | 553 |
| License for libjpeg | 554 |
| License for libunwind | 555 |
| License for the Perl JSON Library | 555 |
| License for OpenSSL | 558 |
| License for WebP | 561 |
| License for Flex | 562 |
| License for zlib | 563 |
| License for XML::Twig | 564 |
| License for MIT Kerberos | 564 |
| License for Libedit | 593 |
| License for ZebOS | 594 |
| License for Curl | 595 |
| License for Jansson | 595 |
| License for Digest::SHA | 596 |
| License for Sys::SysLog | 596 |

| | |
|--|------------|
| License for libpcap | 597 |
| License for elfutils | 597 |
| License for libpng | 604 |
| License for Perl | 607 |
| License for xmlsec | 610 |
| License for ltrace | 613 |
| License for YAML::XS | 620 |
| License for GeoNames | 622 |
| License for LibYAML | 629 |
| License for giflib | 630 |
| License for Gorilla Websocket | 630 |
| License for Go | 631 |
| Open Source Software Notice | 633 |

Preface

Document conventions

The document conventions describe text formatting conventions, command syntax conventions, and important notice formats used in Ivanti technical documentation.

Text formatting conventions

Text formatting conventions such as boldface, italic, or Courier font may be used in the flow of the text to highlight specific words or phrases.

| Format | Description |
|--------------------|---|
| bold text | Identifies command names |
| | Identifies keywords and operands |
| | Identifies the names of user-manipulated GUI elements |
| | Identifies text to enter at the GUI |
| <i>italic text</i> | Identifies emphasis |
| | Identifies variables |
| | Identifies document titles |
| Courier Font | Identifies command output |
| | Identifies command syntax examples |

Command syntax conventions

Bold and italic text identify command syntax components. Delimiters and operators define groupings of parameters and their logical relationships.

| Convention | Description |
|------------------|--|
| bold text | Identifies command names, keywords, and command options. |

| Convention | Description |
|------------------------------------|---|
| <i>italic text</i> | Identifies a variable. |
| [] | Syntax components displayed within square brackets are optional. Default responses to system prompts are enclosed in square brackets. |
| { x y z } | A choice of required parameters is enclosed in curly brackets separated by vertical bars. You must select one of the options. |
| x y | A vertical bar separates mutually exclusive elements. |
| < > | Non-printing characters, for example, passwords, are enclosed in angle brackets. |
| ... | Repeat the previous element, for example, member[member...]. |
| \ | Indicates a "soft" line break in command examples. If a backslash separates two lines of a command input, enter the entire command at the prompt without the backslash. |

Notes and Warnings

Note, Attention, and Caution statements might be used in this document.



A Note provides a tip, guidance, or advice, emphasizes important information, or provides a reference to related information.

ATTENTION

An Attention statement indicates a stronger note, for example, to alert you when traffic might be interrupted or the device might reboot.

CAUTION

A Caution statement alerts you to situations that can be potentially hazardous to you or cause damage to hardware, firmware, software, or data.

Requesting Technical Support

Technical product support is available through the Ivanti Global Support Center (PSGSC). If you have a support contract, file a ticket with PSGSC.

- Product warranties—For product warranty information, visit <https://support.pulsesecure.net/product-service-policies/>

Self-Help Online Tools and Resources

For quick and easy problem resolution, Ivanti provides an online self-service portal called the Customer Support Center (CSC) that provides you with the following features:

- Find CSC offerings: <https://support.pulsesecure.net>
- Search for known bugs: <https://support.pulsesecure.net>
- Find product documentation: <https://www.ivanti.com/support/product-documentation>
- Download the latest versions of software and review release notes: <https://support.pulsesecure.net>
- Open a case online in the CSC Case Management tool: <https://support.pulsesecure.net>
- To verify service entitlement by product serial number, use our Serial Number Entitlement (SNE) Tool: <https://support.pulsesecure.net>

For important product notices, technical articles, and to ask advice:

- Search the Pulse Secure Knowledge Center for technical bulletins and security advisories: <https://kb.pulsesecure.net>
- Ask questions and find solutions at the Pulse Community online forum: <https://community.pulsesecure.net>

Opening a Case with PSGSC

You can open a case with PSGSC on the Web or by telephone.

- Use the Case Management tool in the PSGSC at <https://support.pulsesecure.net>.
- Call 1-844 751 7629 (Toll Free, US).

For international or direct-dial options in countries without toll-free numbers, see <https://support.pulsesecure.net/support/support-contacts/>

Traffic Manager Overview

This chapter introduces Pulse Secure Virtual Traffic Manager (the Traffic Manager), describes the available product variants, and gives an overview of the content in this guide.

Introducing the Traffic Manager

The Traffic Manager product family provides high-availability, application-centric traffic management and load balancing solutions in a range of software, appliance-ready, virtual appliance, and cloud-compute product variants. They provide control, intelligence, security and resilience for all your application traffic.

The Traffic Manager is intended for organizations hosting valuable business-critical services, such as TCP and UDP-based services like HTTP (Web) and media delivery, and XML-based services such as Web Services.

The Traffic Manager's unique process architecture ensures it can handle large volumes of network traffic efficiently. Its inherent scalability allows you to add more front-end Traffic Manager or back-end servers to your cluster as the need arises. The cluster size is unlimited, and the performance of the Traffic Manager grows in line with the performance of the platform used.

The Traffic Manager represents a family of highly capable solutions that can be adapted and extended as new requirements arise. Using the unique TrafficScript language and built-in Java Extensions you can write sophisticated, tailored traffic management rules to inspect, transform, manage and route requests and responses. TrafficScript rules can manage connections in any TCP or UDP-based protocol.

Traffic Manager products are secure out-of-the-box, and are hardened against intrusion and Denial-of-Service (DoS) attacks. They incorporate the fastest and strongest ¹ (SSL) encryption technologies, and can efficiently decrypt and re-encrypt large numbers of secure connections. TrafficScript rules, security policies and other content-based calculations can be applied to encrypted requests while retaining full end-to-end security.

¹The Traffic Manager supports SSL and its successor TLS (Transport Layer Security). References to SSL throughout this guide typically refer to both protocols, unless specified independently.

For critical, high-availability solutions, the Traffic Manager offers cluster redundancy. This allows you to have unlimited numbers of active and passive standby front-end servers. If one of your active machines fails, a standby server is automatically brought into action; in the case of subsequent failure, more standby servers are available to take up the load. This ensures that there is no single point of failure in the system.

Typical Deployment

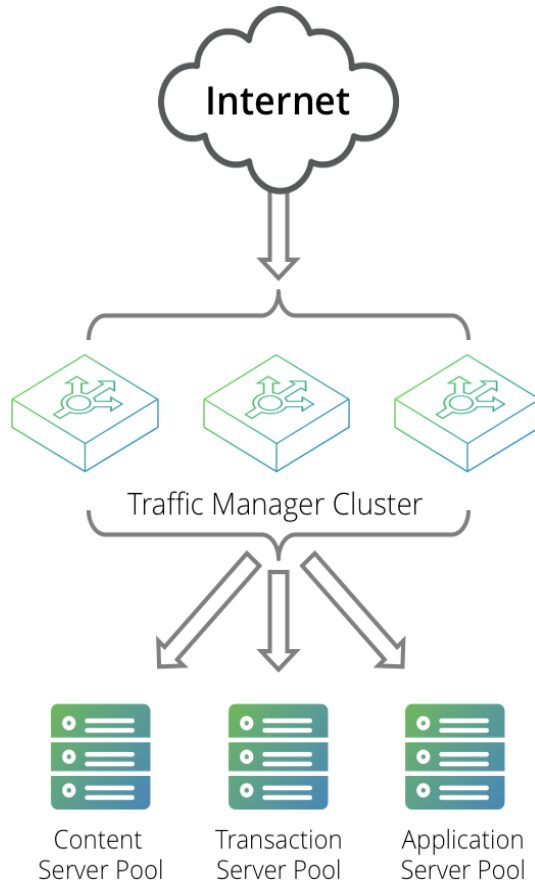

Traffic Manager Product Variants

The Traffic Manager product family is available in a variety of software, hardware appliance, virtual appliance, and cloud instance configurations.

All variants share the same core Traffic Manager software, but different versions might provide different levels of functionality depending on the host platform or enabling license key.

This guide documents the full functionality of the Traffic Manager software with all options enabled. It might describe features and capabilities that are not present or visible in the version of the product you are using. Features present but not enabled are greyed-out and un-selectable in the Admin UI.

Ivanti provides a number of optional Traffic Manager components, available only through an appropriate license key upgrade:

- Pulse Secure Virtual Web Application Firewall (vWAF): Provides advanced attack detection and protection for your Web applications. See [The Pulse Secure Virtual Web Application Firewall](#) for more details about how this fits into your Traffic Manager infrastructure. For full product details and instructions, see the *Pulse Secure Virtual Web Application Firewall: User's Guide*, available from the Ivanti Web site at www.ivanti.com.
- Pulse Secure Web Accelerator (Web Content Accelerator): Provides content optimization functionality for your Web applications. This is available as either a fully integrated component of the Traffic Manager, or in standalone proxy mode whereby the load balancing aspects of the Traffic Manager are disabled. Your sales representative can provide details about which variant is most appropriate for your needs. [Using Pulse Secure Web Accelerator](#), provides full details about how to enable and configure Web Content Accelerator for your infrastructure.

Your product version specifications describe which capabilities are enabled in your particular variant. See also the applicable Pulse Secure Virtual Traffic Manager: Installation and Getting Started Guide available from the Ivanti Web site at www.ivanti.com.

The Traffic Manager Community Edition

When unlicensed, the Traffic Manager defaults to running as the Community Edition. In this state, the Traffic Manager operates normally and with full functionality, but with a bandwidth limit of 10Mb/second and cluster size limit of 4. The Community Edition is designed as a free, production-ready, variant of the Traffic Manager useful for system administrators and application developers wanting to try out advanced vADC (virtual Application Delivery Controller) capabilities in a production environment.

Ivanti recommends that you contact your support provider for details of how to purchase a license key suitable for your needs.

Supported Platforms

The Traffic Manager software can be deployed on a range of platforms, on physical or virtual servers, and in cloud infrastructures. Refer to the release notes and documentation at www.ivanti.com for up-to-date platform and version number requirements.

Software

The Traffic Manager is available as a software package suitable for deployment on existing supported Linux and UNIX servers. Supported distributions are listed in the release notes as mentioned above.

Appliances

Ivanti provides the Traffic Manager as an appliance disk image, suitable for deployment on approved server hardware platforms.

Virtual Appliances

Ivanti provides Traffic Manager virtual appliance packages for VMware vSphere, Citrix XenServer, Microsoft Hyper-V, and QEMU/KVM.

Cloud Computing Services

The Traffic Manager is supported for Amazon's Elastic Compute Cloud (EC2), Rackspace, Microsoft Azure, and Google Compute Engine (GCE). Ivanti additionally supports installing the Traffic Manager software variant on supported Linux and UNIX virtual machine instances running on EC2 and GCE.

Supported Cluster Combinations

As discussed in previous sections, The Traffic Manager is available as a number of product variants on a selection of platforms. In addition to the core Traffic Manager software, various product options and capabilities are available through a suitable license upgrade.

When clustering multiple Traffic Managers together for high-availability and redundancy, it is possible to take advantage of The Traffic Manager's flexible architecture and host instances on different platforms within the same cluster. However, some care must be taken to ensure that each cluster member is running the same product configuration.

The following should be taken into account when planning your cluster:

- Mixing different supported host operating systems for the software variant is supported and should not adversely affect cluster operations.
- Although mixing license key types is technically possible within the cluster, it is not recommended. There are likely to be warnings and/or errors within the Admin UI if features only licensed on a sub-set of the cluster are used. This is due to the automatic config replicator attempting to apply non-licensed functionality across the cluster.
- Cloud instances cannot directly be clustered with non-cloud instances (software, virtual appliance, hardware appliance). However, the multi-site cluster management¹ feature enables centralized control of multiple Traffic Manager clusters regardless of location.
- The vWAF feature cannot be used in a mixed-platform cluster (for example, software and virtual appliance).
- Having different product versions within a cluster is unsupported, except in the case of performing an upgrade (or downgrade) of the entire cluster. During this transient state, some Traffic Managers will report that they are running different versions to others in the cluster. This is to be expected, and you should find that such error conditions are cleared once all cluster members have been upgraded.

If you are in any doubt as to the potential effects of running your proposed Traffic Manager infrastructure, Ivanti recommends contacting your support provider for assistance.

Chapter Outline

- [Essentials of Network Configuration](#)

This chapter discusses the network configuration needed for a typical traffic-managed server farm. It covers hardware requirements, the layout of the network, IP addresses and DNS entries.

- [Initial Configuration](#)

This chapter explains the concepts of the Traffic Manager architecture, including its system of Virtual Servers, Pools and Rules. It describes how to start managing your first service.

- [Virtual Servers](#)

Virtual servers are one of the two fundamental configuration concepts in the Traffic Manager software. This chapter describes virtual servers in more detail.

¹See [Multi-Site Cluster Management](#)

- [Pools](#)

A pool is the second of the two fundamental configuration concepts in the Traffic Manager software. This chapter describes pools in more detail.

- [Traffic IP Groups and Fault Tolerance](#)

Fault Tolerance—resilience to failures of back-end servers or individual Traffic Manager systems—is covered in this chapter.

- [Key Features in the Traffic Manager Administration Interface](#)

Now that you have a basic Traffic Manager system running, this chapter covers the Traffic Manager's performance monitoring and diagnosis functions and other tools in the Traffic Manager Administration Interface.

- [TrafficScript Rules](#)

This chapter introduces the TrafficScript language, used for writing rules to manage your traffic. It explains how to create rules and gives some examples. A separate *Pulse Secure Virtual Traffic Manager: TrafficScript Guide* describes the Traffic Manager's TrafficScript capability in full detail.

- [Providing Authentication for your Services](#)

This chapter provides details about remote authentication support. Use the mechanisms described in this chapter to add remote user verification to your services.

- [Java Extensions](#)

This chapter describes the Traffic Manager's Java Extensions, allowing you to invoke Java code from TrafficScript. A separate *Pulse Secure Virtual Traffic Manager: Java Development Guide* describes the Traffic Manager's Java Extensions capability in full detail.

- [Protocol Support](#)

Some protocols can benefit from specific support, and this chapter describes special protocol handlers in the Traffic Manager.

- [Session Persistence](#)

This chapter describes the Traffic Manager's session persistence features. It outlines some useful session persistence strategies and explains how it is set up within the product.

- [SSL Encryption](#)

This chapter deals with SSL decryption of incoming traffic, and encryption of requests being sent to the back-end servers. It describes how to set up SSL certificates, authorities and revocation lists within the product and how to apply them to your services.

- [Health Monitoring](#)

This chapter discusses the Traffic Manager's Health Monitoring capabilities. Health Monitors are used to test the correct operation of back-end server nodes; in the event of a failure, they cause the Traffic Manager to raise an alert, and to route traffic away from the failed node.

- [Service Protection](#)

This chapter describes the service protection capabilities of the product. It explains how a class of service protection settings can be defined in the catalog, and used by one or more services.

- [Bandwidth Management](#)

This chapter describes the bandwidth management capabilities of the product. It explains how a class of bandwidth management settings can be defined in the catalog, and used by one or more services.

- [Request Rate Shaping](#)

This chapter describes how a Traffic Manager can be used to rate-shape requests to your servers and applications to restrict users' activities and prevent applications from being overwhelmed by requests.

- [Service Level Monitoring](#)

This chapter describes the service level monitoring of the product. It explains how a class of service level monitoring settings can be defined in the catalog, and used by one or more services.

- [Content Caching](#)

This chapter describes the Traffic Manager's HTTP Content Caching capabilities. You can cache commonly requested Web resources and respond to subsequent requests directly from the cache, rather than forwarding many identical requests to the back-end server nodes.

- [Using Pulse Secure Web Accelerator](#)

This chapter covers the Web Content Accelerator and how you can apply Web content optimization to your Web services.

- [Event Handling and Alerts](#)

This chapter describes how to control what the Traffic Manager does when particular events occur, and how to inform or drive external management systems.

- [Configuring System Level Settings](#)

This chapter describes additional system level configuration specific to hardware appliance, virtual appliance, cloud instance, and certain software variants of the Traffic Manager.

- [System Security](#)

This chapter gives tips for secure operation of your Traffic Managers. It covers firewalling and network design, and Unix software permissions that are relevant to the Traffic Manager software.

- [Administration System Security](#)

This chapter covers security measures to control access to the Administration Interface, including user authentication against external databases.

- [The Traffic Manager Control API](#)

This chapter gives a brief introduction to the Traffic Manager's Control API. For full information, see the separate *Pulse Secure Virtual Traffic Manager: Control API Guide*, available from the Ivanti Web site.

- [Command Line Interface](#)

This chapter covers the Command Line Interface in detail, with reference to the Control API methods defined in the *Pulse Secure Virtual Traffic Manager: Control API Guide*.

- [Granular Configuration Import/Export with zconf](#)

This chapter describes the zconf command line utility that can be used to perform a fine-grained import/export on individual configuration objects.

- [Multi-Site Cluster Management](#)

Furthering the concept of a cluster of Traffic Managers, this chapter introduces the idea of combining several clusters into one centrally managed multi-site super-cluster.

- [The Traffic Manager DNS Server](#)

The Traffic Manager provides an internal DNS server capability as an alternative to externally sourced DNS. This chapter discusses the implementation and configuration of the Traffic Manager DNS server.

- [Global Load Balancing](#)

This chapter discusses the implementation of Global Server Load Balancing (GSLB) within the Traffic Manager.

- [FIPS Validation in the Traffic Manager](#)

This chapter provides details for prospective users looking for information on how FIPS is implemented in the Traffic Manager.

- [Kerberos Constrained Delegation Support](#)

This chapter discusses the Traffic Manager's implementation of the Kerberos protocol.

- [Troubleshooting](#)

This chapter describes how to investigate and diagnose problems or unexpected behavior with your load-balanced system.

- [Glossary](#)

The Glossary defines some terms used in this manual. Some of these terms are used with varying meanings in computing literature, so if in doubt you should refer to this section.

Network Layouts

This chapter discusses the configuration of your network. It describes the hardware you will need for an effective traffic-managed server farm, and the DNS and IP address layout.

Essentials of Network Configuration

The components of a basic traffic-managed server farm are:

- One or more front-end machines running the Traffic Manager software
- A number of back-end servers (such as web or mail servers)

The front-end machines must be able to receive traffic from the Internet (or where the remote clients are located). They must also be able to contact the back-end machines.

The back-end servers will usually be visible only from an internal network. The front-end machines do not need to route traffic between the Internet and the back-end machines.

The Traffic Manager software is commonly deployed on a multi-homed machine. One network interface card is visible to the Internet; one or more network interface cards are exposed to the internal private networks where the back-end servers reside. It is also easy to configure a Traffic Manager on a machine with a single network card (this is common in an evaluation or testing environment), where a Traffic Manager can contact both the clients and the servers.

A fully fault-tolerant set-up will contain two or more front ends and several back-end servers. If any one machine fails, the Traffic Manager's failover capability ensures that requests are routed to other machines, ensuring there is no single point of failure in the system.



Some product versions are restricted to just a cluster size of two Traffic Manager machines. Larger cluster sizes can be used with a software key upgrade.

If hardware availability is limited, fewer servers can be used. In the minimal case, it is possible to install the traffic management software and an Internet service on the same machine. This is not recommended, as it reduces the usefulness of the product and the ability to provide fault tolerance in the event of a hardware failure. It may, however, be useful for evaluation or demonstration purposes.

The Traffic Manager can be used in conjunction with a stand-alone firewall. In this scenario, your Traffic Managers should be visible from both the Internet and your internal network. Ivanti recommends you place your Traffic Managers in the applicable DMZ.



[System Security](#) discusses the security aspects of network setup in more detail. Ivanti advises you to read that chapter before setting up live services.

Dedicated Management Network

When you configure a Traffic Manager, you can choose to nominate a single management IP address. The Traffic Manager then only accepts management traffic on that address. See the Pulse Secure Virtual Traffic Manager: Installation and Getting Started Guide applicable to your product variant for the configuration procedure required to set a dedicated management IP address.

For Traffic Manager documentation, see the Ivanti Web site at: www.ivanti.com

Management traffic includes all access to the Web-based Traffic Manager Admin UI, the Control API, the REST API, and any configuration or state sharing within a Traffic Manager cluster.

You can use the management IP address to provide a dedicated, trusted management network. Typically, each host running a Traffic Manager has a dedicated network card that is connected to the management network.



For more information on the security aspects of network setup, see [System Security](#). Ivanti recommends you read this chapter carefully before setting up live services.

To modify the management IP address on a fully configured Traffic Manager, login to the Traffic Manager Admin UI and click **System > Security > Management IP Address and Admin Server Port**. Set "bindip" to the required management IP address, then click **Update** to save your changes. For software variants, you can also rerun the "configure" script. Note that a software restart is required for this procedure.

Each management IP address is a single point of failure in a Traffic Manager cluster. If the management network fails, all inter-machine communication is lost and remote configuration using the Admin UI, Control API or REST API is impossible.

For resilience, the fault-tolerance messages that each Traffic Manager sends are broadcast over all network cards. You can restrict this traffic to the management network in the Admin UI.

Sizing Your Cluster

Back-End Servers

The Traffic Manager can support an unlimited number of back-end servers. These might include Web servers, mail servers and FTP servers. They can run any software on any platform to provide the services the Traffic Manager manages.

The servers can be arranged into pools to serve different types of content. For instance, you can have several groups of Web servers, including Windows machines running IIS™ and UNIX machines running Zeus Web Server or Apache™, to serve different types of static and dynamic Web content. The Traffic Manager's system of pools and rules allows you to classify requests and send them to different groups of servers. Pools and rules are explained in [Initial Configuration](#)

The number of servers you dedicate to a certain function may vary. To serve static Web pages, if requests are light, two Linux machines could be sufficient; while more complex Sun JSP™ or Microsoft ASP pages might be served by larger numbers of machines.

The Traffic Manager allows you to use any number of machines; should your requirements change, you can add or remove back ends dynamically without disrupting your service.

Content Management on Back Ends

If a number of back ends serve the same site, changes in the site content must be propagated to each back-end server. This can be done in one of two ways:

- Each back end can store a local copy of the content, and the data can be synchronized regularly.
- A shared file system can be used, such as an NFS file server. This stores the content, and each back-end server retrieves data when required.

To serve static Web content, either content management method works well. For SMTP or POP3 servers, a shared file system will be needed because files are modified by that service.

Front-End Servers

A simple deployment of Traffic Managers would involve one front-end machine. This gives access to the full functionality of the Traffic Manager software, except for front-end fault tolerance. In other words, the Traffic Manager machine is a potential single point of failure.

For a fully fault-tolerant set-up, two or more Traffic Managers should be used. Their IP addresses can be arranged into a Traffic IP Group which provides fault tolerance if one machine should fail. Traffic IP groups are described in [Traffic IP Groups and Fault Tolerance](#)

A common network deployment is to have the front-end machines on two separate networks: one to communicate with the Internet, and one with the back ends (probably a private network). It is possible, however, to deploy front ends and back ends on just one network. You should ensure that all machines routable from the Internet are appropriately firewalled. See [System Security](#) for a discussion of firewalling and network security.

You might want to increase throughput by adding extra network cards to your Traffic Managers. Having two network cards can also simplify deploying a Traffic Manager on two separate networks, although it is not necessary for this.

The Traffic Manager is highly scalable. Adding more servers or upgrading your existing hardware will increase the performance of your traffic management correspondingly. If you wish to add more Traffic Manager machines later, this can be done easily without disturbing your existing set-up or interrupting your service.



If you are using a software version of the Traffic Manager product family, you should ensure that the host machine is not overloaded with other applications and services. For example, running a web browser or other GUI tools on the same server will diminish the capacity of the software to manage traffic on the server.

The diagram that follows shows a typical traffic-managed server farm. The front-end machines have separate front-end and back-end network cards as described previously.

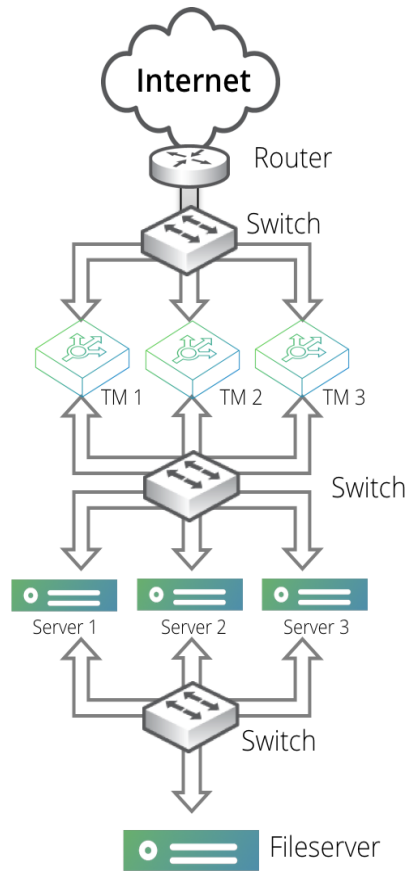

Content served by the back ends is held on an NFS file server. Each back-end server has two network cards, one to talk to the Traffic Manager machines and one to talk to this file server, to maximize throughput.

IP Transparency

Your Traffic Manager functions as a full application proxy, terminating network connections from remote clients and making new connections to the selected back-end servers. It does not use the packet-orientated NAT-based load balancing methods that simple layer-4 load balancers use.

With this architecture, the back-end server views the client's request as originating from the Traffic Manager, not from the remote client. This can be a disadvantage if the back-end server performs access control based on the client's IP address, or if the server wishes to log the remote IP address. This can often be worked around by performing the access control or logging functions on the Traffic Manager itself, or by making use of the "X-Forwarded-For" or "X-Cluster-Client-Ip" headers that the Traffic Manager can insert into every HTTP connection to identify the client's IP address.

In situations where these workarounds are not appropriate, the Traffic Manager can spoof the source IP address of the server-side connection so that it appears to originate from the client's remote IP address. This capability is known as IP transparency.

IP Transparency can be used selectively. For example, if the Traffic Manager was balancing traffic for a Web farm and a mail farm, you might want SMTP traffic to be IP transparent, but not require that the Web traffic is transparent.

Transparency is enabled on a per-pool basis; you can configure a Web pool that is not transparent, and an SMTP pool that is transparent. The Web pool and the SMTP pool can balance traffic onto the same back-end nodes, or different nodes.

IP Transparency is available by default on all versions of the Traffic Manager appliance image, virtual appliance, or cloud service. Traffic Manager software variants can use native IP transparency functionality on Linux or UNIX hosts under the following conditions:

- The Traffic Manager software is installed and running as the root user.
- The host operating system uses a kernel at version 2.6.24 or later.
- The host operating system uses iptables at version 1.4.11 or later (versions of iptables earlier than 1.4.11 are also supported provided the "--transparent" option is available).

Routing Configuration

Each server node that receives transparent traffic must route its responses back through the Traffic Manager that sent it. This is achieved by configuring the default route on the node to be one of the back-end IP addresses of the Traffic Manager. See your operating system documentation for details about configuring the default route.

When the server node replies to a request, it will address its response to the remote client IP. Provided the routing is configured correctly, the originating Traffic Manager will intercept this traffic, terminate the connection and process it as normal. The Traffic Manager will then forward the (possibly modified) response back to the client.

It is normally appropriate to configure the Traffic Manager to simply forward on all other packets that are not addressed to it. This will allow the system to function as a local router, so that servers using it as their default route can then contact other systems on nearby or remote networks. The Traffic Manager will need to NAT any packets that it forwards from back-end nodes on private networks.



Refer to your operating system documentation to configure "IP Forwarding" on a host system running the Traffic Manager software variant. See [Configuring System Level Settings](#) to configure this behavior on a Traffic Manager virtual appliance or cloud instance.

Local Routing Problems

If you use IP transparency, clients on the same network as the back-end nodes will not be able to balance traffic through the Traffic Manager to those nodes.

This is because the back-end server nodes always attempt to reply to the source IP address of the connection. If the source IP address (the client's IP) resides on a local network, the server nodes will attempt to contact the client directly rather than routing via the Traffic Manager system that originated the connection. The connection will appear to hang.

In this case, it might be appropriate to segment the back-end network so that, from the server nodes' perspective, the clients appear to reside on a separate subnet, which must be reached via the default gateway (the Traffic Manager system). Alternatively, a TrafficScript rule could selectively set the source IP address of the server connection to an IP on the Traffic Manager system if the client lies on the same network as the server nodes.

IP Transparency and Traffic Manager Clusters

IP routing is more complex in the case where a cluster of Traffic Managers is used, because each server node can only route back through one IP address.

See [Traffic IP Addresses and Traffic IP Groups](#) for recommendations in this situation.

Traffic IP Addresses and Traffic IP Groups

In a typical network, your back-end servers will be arranged in a local network, with local IP addresses, and will not directly be contactable from the Internet. The front-end Traffic Manager machines will have externally available IP addresses, and will be able to connect to the back-end machines over the local network.

The front-end machines will have permanent IP addresses on each network, with the front-end addresses visible and routable from the Internet. These IP addresses are configured by the OS, and if the machine fails, the IP address is lost.

For this reason, these permanent IP addresses are not suitable to use when you publish your services. In the event of a hardware or system failure, your services would become partially or wholly unavailable.

The Traffic Manager's fault tolerance capability allows you to configure Traffic IP addresses. These IP addresses are not tied to individual machines, and the Traffic Manager cluster ensures that each IP address is fully available, even if some of the clustered Traffic Manager machines have failed.

In a typical fault-tolerant configuration, the DNS name used to publish your services is configured to resolve to the traffic IP addresses in your Traffic Manager cluster. This ensures that your services are always fully available.

The traffic IP addresses are arranged into a Traffic IP group. This group spans some or all of your Traffic Manager machines. The machines negotiate between them to share out the traffic IP addresses, each Traffic Manager then raises the IP address (or IP addresses) allocated to it.

Setting up traffic IP groups is described in [Traffic IP Groups and Fault Tolerance](#).

If any Traffic Manager machine should fail, the other Traffic Managers in the group detect this. One of them then takes over the failed machine's traffic IP addresses to ensure that the service is uninterrupted.

 By default, fault tolerance uses unicast traffic to distribute health information and to manage traffic to multi-hosted Traffic IP Addresses. If you change your configuration to use multicast traffic, the switches that your Traffic Managers are connected to must support IGMP snooping, and messages broadcast to the multicast address used by your Traffic Managers should be forwarded to all Traffic Managers in the cluster.

When you join a Traffic Manager to an existing cluster, a number of tests are conducted automatically to ascertain whether broadcast messages are correctly forwarded.

Traffic IP Address Modes

The Traffic Manager supports several modes:

- **Single-hosted:** Traffic IP addresses are raised on a single Traffic Manager in your fault tolerant cluster. If that Traffic Manager fails, another Traffic Manager will raise that IP address and start accepting traffic.

- **Multi-hosted:** Traffic IP addresses are raised on all of the Traffic Managers in your cluster, using a multicast MAC address that ensures that all incoming traffic is sent to all machines. A custom Linux kernel module is used to evenly distribute the traffic between the working Traffic Managers.
- **Route Health Injection:** Traffic IP addresses are raised "privately" (on loopback) by all participating Traffic Managers, and dynamically advertised into the adjacent routing domain, using either Open Shortest Path First, version 2, (OSPFv2) or Border Gateway Protocol (BGP) as the routing protocol. In response, routers direct traffic to the active Traffic Manager. See [Route Health Injection and the Network](#).

Enabling Multi-Hosted Traffic IP addresses imposes a performance hit due to the additional packet processing required by the Traffic Managers in your cluster. Empirical tests indicate that CPU utilization will increase by 25-30% at moderate traffic levels (10,000 requests per second), with a corresponding limit on top-end capacity.



Multi-hosted IP functionality is available on all versions of the Traffic Manager hardware appliance and virtual appliance. It is not included by default with the Traffic Manager software variant; however, you can download and install it as an additional kernel module. It is supported on Linux kernels, version 2.6.18 and later. For further information regarding supported versions, see the Pulse Community Web site at <https://community.pulsesecure.net>.

Example Configurations

These configurations assume that you have two Traffic Managers in your cluster, but can be extended if your cluster contains three or more Traffic Managers.

Active-Passive Configuration – Single-Hosted and Route Health Injection Modes

Suppose your Web site's external DNS name maps to the IP address 162.34.64.29. You have two Traffic Manager machines handling traffic for a number of back-end Web servers:

- With single-hosted mode, you can set up a single-hosted traffic IP group spanning both Traffic Manager machines, containing this single IP address. The Traffic Managers will negotiate and one of them will raise the IP address. It handles all the incoming requests. The second Traffic Manager machine is available on standby. If the first machine should fail, the second machine takes over the IP address and starts to manage the traffic.

- With Route Health Injection (RHI) mode, you can set up an RHI traffic IP group spanning both Traffic Managers, containing the single IP address. Set one Traffic Manager as active and the other as passive. Both Traffic Managers advertise the IP address, using an OSPFv2 and/or BGP (depending on your choice of routing protocol) metric to express preference (the active Traffic Manager uses a lower metric). The upstream router (typically your default gateway) chooses the lowest metric route, sending all traffic to the active Traffic Manager. If the Traffic Manager detects a failure, it cancels the advertisement. If the router detects a failure, it disregards that route. In either case, the router switches to sending traffic according to the next-best metric advertisement, which in this case is the passive Traffic Manager.

The advantage of this configuration is that you can be confident that there is sufficient resource in reserve to handle the traffic should one of the two Traffic Managers fail. Debugging and fault resolution is easier when only one Traffic Manager is handling traffic.

Active-Active Configuration – Single and Multi-Hosted Modes

In an active-active configuration, both Traffic Managers manage your traffic. The distribution mode (single-hosted IP or multi-hosted IP) controls how the traffic is shared between them.

With single-hosted mode, you can configure two traffic IP addresses in a traffic IP group, and configure your DNS name to map to the two addresses, such as 162.34.64.29 and 162.34.64.30. The Traffic Managers will negotiate to raise one traffic IP address each. A DNS server can allocate requests to each IP address in turn (round-robin DNS), and each Traffic Manager handles the requests it receives.

If one of the machines fails, the other machine will detect this. It will then raise the failed machine's traffic IP address in addition to its own, and handle all the traffic sent to either address.

With multi-hosted mode, you can continue to operate with one traffic IP address, simplifying your DNS and reducing the number of externally facing IP addresses you require. The traffic IP address is raised on all of the Traffic Managers in the traffic IP group, and incoming traffic to that IP address is shared evenly between the Traffic Managers.

Active-Active with Loopback (Single External Address, Single Hosted Mode)

If multi-hosted mode is not available or prohibited in your infrastructure, you can distribute traffic load to all of the Traffic Managers in your cluster, while still using a single external traffic IP address.

This configuration involves an additional "loopback" virtual server that listens for traffic on the external traffic IP address and then load-balances the requests across the Traffic Managers using their permanent IP addresses.

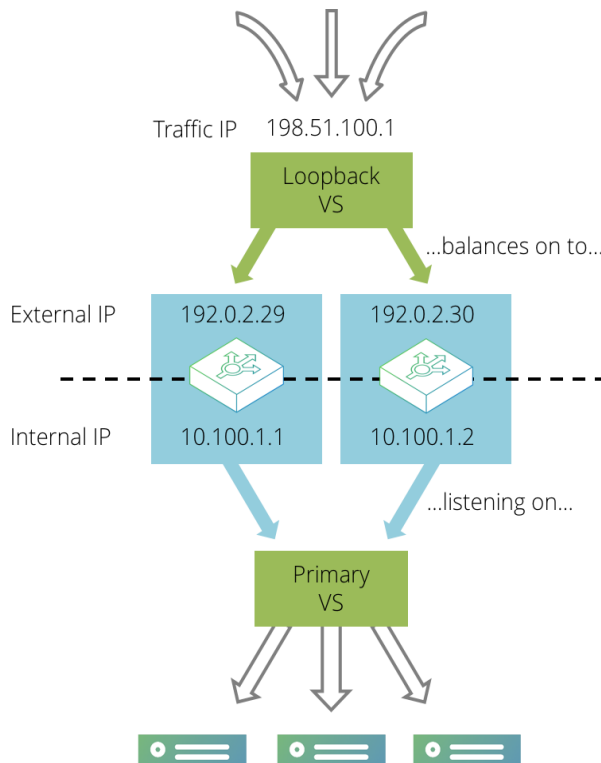

First, create your primary virtual server that processes traffic and load-balances it across the back-end servers. Configure this virtual server so that it listens on internal IP addresses and ports on each Traffic Manager, rather than externally accessible ones. For example, the virtual server could listen on 192.0.2.1:80 and 192.0.2.2:80, where the IP addresses are internally visible only.

Then, create a second “loopback” virtual server that listens on the single external IP address and immediately distributes traffic to the primary virtual server across the various Traffic Manager machines in your cluster.

As in the active-passive example, set up a single traffic IP address that will be raised by one Traffic Manager only. Any traffic coming in to this address should then be processed by the simple loopback virtual server, which is listening on that traffic IP address. The loopback virtual server should immediately select a loopback pool that contains the internal IP addresses of the Traffic Manager machines in the cluster; the loopback pool should use either round-robin or least connections load balancing to evenly distribute traffic across the Traffic Manager machines in the cluster. It should not use a load-balancing method that is influenced by response time, as that will give very uneven request distribution.

The loopback virtual server uses little processing power. Ensure that all of the CPU-intensive processing is performed by the primary virtual server - tasks such as SSL decryption, rules, content compression, and so on.

This method splits the load of more intensive tasks between the two Traffic Managers. If either Traffic Manager fails, the service will continue to run (perhaps with a momentary interruption to some traffic). For example, if the Traffic Manager that is hosting the external traffic IP address were to fail, the traffic IP would be transferred to the remaining Traffic Manager. The loopback pool will detect that one of the nodes was unavailable and direct all traffic to the primary virtual server running on the remaining Traffic Manager.

The target virtual server will observe the connection originating from the loopback virtual server, not the remote client. Generally, the "X-Forwarded-For" or "X-Client-Cluster-Ip" headers can be used to determine the correct source for the connection, but in the common case where SSL requests are forwarded by the loopback virtual server, you should use the `ssl_enhance` and `ssl_trust_magic` settings described in the Preserving IP Addresses with SSL Forwarding section in [SSL Encryption](#)

Multiple-Redundant (N+M) Configuration

In the earlier cases, two Traffic Manager machines are used; if one should fail, a single point of failure is introduced into the system. When running mission-critical services, a higher level of protection can be employed by incorporating several additional Traffic Manager machines to form a multiple-redundant cluster.

Suppose that in normal operation you want to use N active Traffic Managers. You would then incorporate M passive Traffic Managers, where M is the number of machines that could potentially fail without reducing the number of Traffic Managers in operation.

To achieve this arrangement, you would need N+M front-end machines running the Traffic Manager. You can create a traffic IP group containing N traffic IP addresses, yet spanning all N+M machines. If a machine in your active group fails, a backup machine from the passive group is brought into active duty to take up the load. If another machine fails, an additional passive Traffic Manager becomes active, and so on. This is a typical clustering arrangement incorporating multiple layers of redundancy.

Using IP Transparency with a Cluster

Using IP transparency with a cluster of Traffic Manager machines introduces additional complexity because each server node is configured to route to a single Traffic Manager IP address. However, any of the Traffic Manager machines in the cluster may send transparent connections to the server nodes, and the nodes must route each response back via the Traffic Manager that originated the connection.

Active-Passive Configuration

With a single active Traffic Manager configuration, this can be achieved using the **keeptogether** setting in a traffic IP group that uses single-hosted IP addresses.

Create a traffic IP group containing two IP addresses; the front-end IP address for incoming traffic, and a back-end IP address that resides on the server side network. Select the **keeptogether** option in the traffic IP group.

Configure each back-end server to route all traffic via the back-end IP address you configured in the traffic IP group.

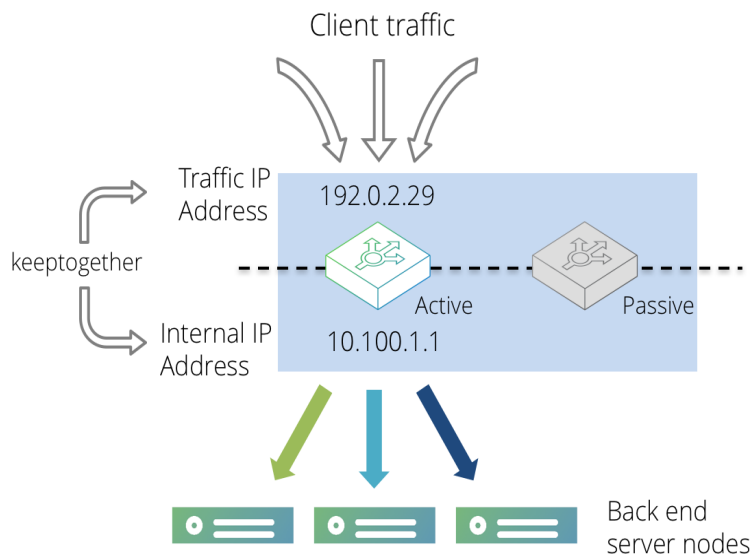

With this configuration, both IP addresses will be hosted on the same Traffic Manager machine. If that machine were to fail, both IP addresses would be migrated to the same passive machine, making it the new active machine. The back-end servers will now route traffic back via the new active machine.

Active-Active Configuration

With a configuration involving multiple active Traffic Managers, it is necessary to partition your back-end servers into groups, one for each active Traffic Manager machine. These groups should then be defined as pools within the Traffic Manager Admin UI, adding each back-end server as a node accordingly.

All servers in the same pool should have their default route configured to be the back-end IP address of the corresponding Traffic Manager. Please refer to your operating system documentation for more details about how to manipulate your server route settings.

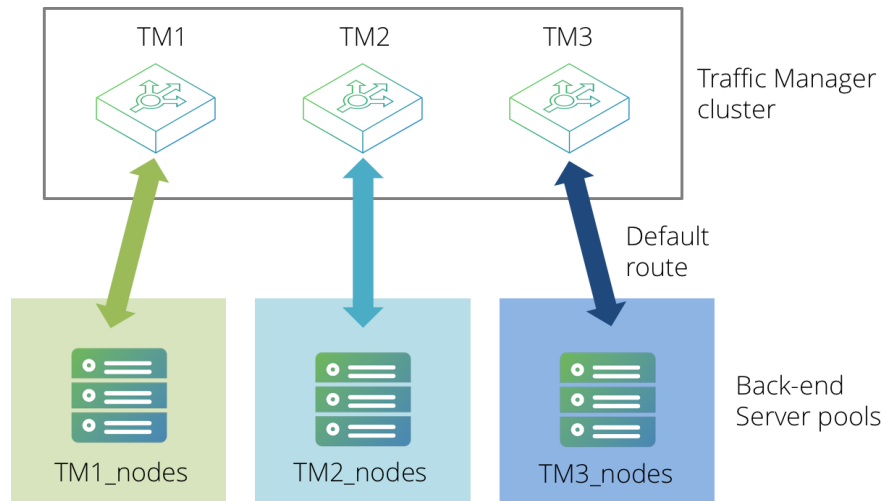

TrafficScript rules can then be used to select the correct pool to route traffic to, based on either of the following items:

- The name of the Traffic Manager that is managing that connection.
- The local client-side IP address (if using several "keep-together" Traffic IP Groups in single-hosted mode).

The following code snippet demonstrates how this might work (using the Traffic Manager name as the selection criteria):

```
$hostname = sys.hostname();

if( $hostname == "TM1" ) {
    pool.use( "TM1_nodes" );
}

if( $hostname == "TM2" ) {
    pool.use( "TM2_nodes" );
}

if( $hostname == "TM3" ) {
    pool.use( "TM3_nodes" );
}
```

This configuration does, however, include the limitation whereby if a Traffic Manager fails the associated pool will become redundant. Additionally, session persistence cannot reliably be used (particularly if multi-hosted IP addresses are in use).

IP transparency can be used selectively. For example, suppose that a Traffic Manager cluster is managing high volume Web traffic to `www.mysite.com`, and low volume SMTP traffic to `mail.mysite.com`. Only the SMTP traffic needs to be transparent. In this case, the following is true:

- `www.mysite.com` can resolve to several IP addresses in an Active-Active TrafficCluster configuration without IP transparency.
- `mail.mysite.com` can resolve to a single IP address using the Active-Passive **keptogether** configuration described above.

Route Health Injection and the Network

When using Route Health Injection (RHI), the Traffic Manager communicates with routers in the adjacent routing domain. Once it has established communication, the Traffic Manager joins the routing domain and advertises RHI traffic IP addresses into it.

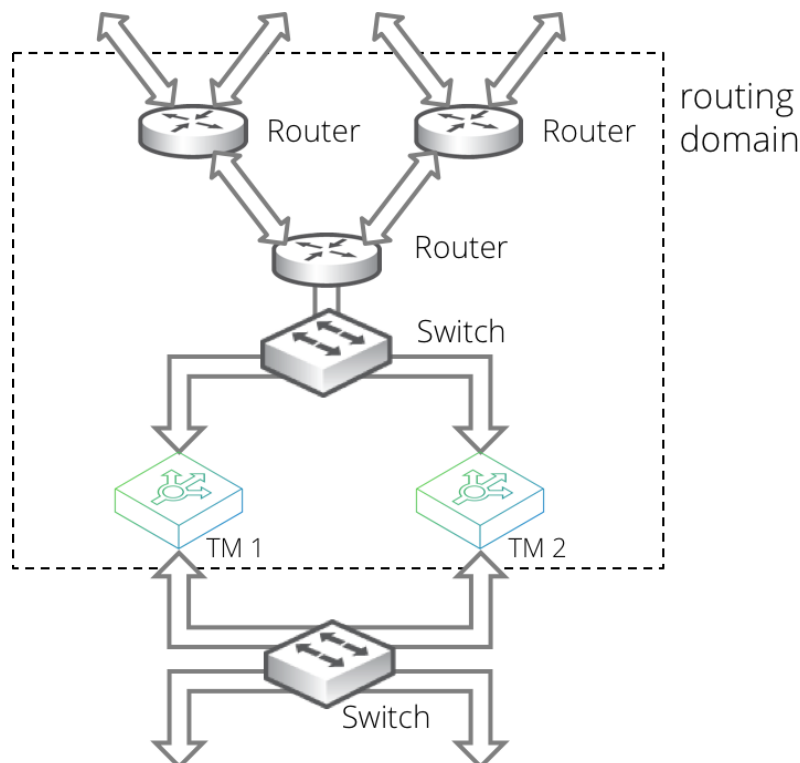

Such advertisements are dynamic and respond automatically to your Traffic Manager configuration changes that create, destroy, or move RHI traffic IP addresses. The advertisements also respond automatically to failures detected by the Traffic Manager, and through the routing domain's dynamic routing protocols, to network failures that are not local to the Traffic Manager.

RHI is therefore able to work in a wide variety of deployments. For example, on a small scale to manage simple local failover (such as within a single datacenter rack), and on a large scale to manage traffic distribution and failover between different datacenters within an enterprise or across the whole Internet.

RHI operates using RHI-designated IPv4 traffic IP groups. In a single location, you can use an RHI traffic IP group serviced by either a single active Traffic Manager, or an active-passive pair of Traffic Managers (See "Active-Passive Configuration – Single-Hosted and Route Health Injection Modes" on page 43).



RHI does not support Traffic IP groups based on IPv6 addresses.

To increase scale, you can repeat this pattern in further Traffic Manager datacenter locations as necessary. Different locations use different RHI traffic IP groups, where the Traffic IP addresses in each group are identical, but the OSPFv2 or BGP metrics used are typically different.



For OSPFv2, this scenario requires all datacenters to be in the same routing domain. For BGP, datacenters can be internal or external to the routing domain.

Locations might have different priorities. For example, with a two-location primary-standby datacenter deployment, you configure the following:

1. In the primary datacenter, configure a primary RHI traffic IP group serviced by an active-passive Traffic Manager pair.
2. In the standby datacenter, configure a standby RHI traffic IP group serviced by an active-passive Traffic Manager pair.
3. Configure the standby RHI traffic IP group with a very high metric, such that the primary datacenter is always preferred unless it is unavailable.

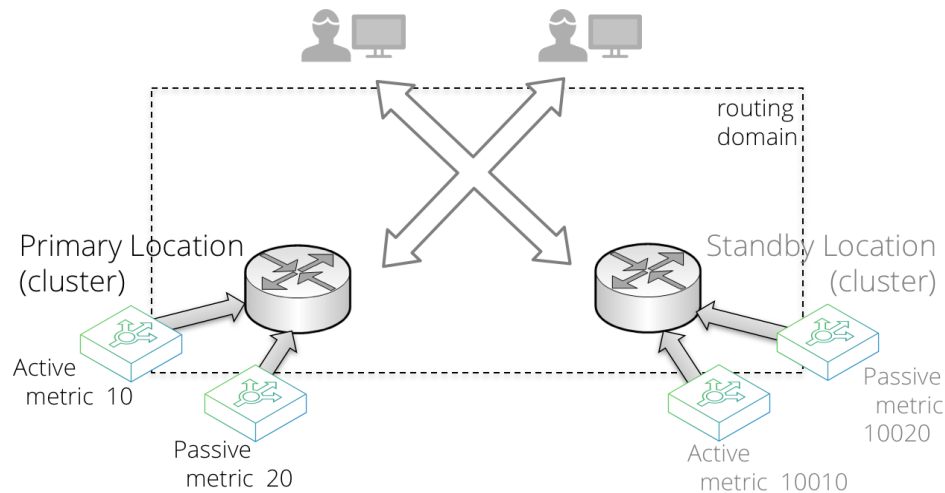

Alternatively, your datacenter locations might have similar priority, resulting in multiple active locations where routing decisions are based on using the best route, according to the network topology. This is often referred to as an anycast configuration. To achieve it, configure the RHI traffic IP groups in each location with the same metrics.



RHI implemented with BGP over multiple locations requires other parts of your infrastructure to be configured to support it. In other words, you must ensure that the routers between your datacenter locations respect the supplied metrics, and do not have other policies configured that might influence location choice.

The Credentials Used for RHI Communications

To implement RHI, each Traffic Manager communicates with adjacent routers using OSPFv2 or by establishing a session with BGP. You must configure your Traffic Manager with suitable credentials to enable the Traffic Manager to establish communications with an adjacent OSPFv2 or BGP enabled router. This process is called "peering" with the router.



OSPFv2 communication requires multicast.

You can create clusters of Traffic Managers that use the same credentials. Each cluster (or each Configuration Location within a Multi-Site Manager cluster; see "Multi-Site Cluster Management" on page 404) uses one set of credentials, and therefore all Traffic Managers in the cluster (or Configuration Location) join the same area (for OSPFv2) or Autonomous System (AS) (for BGP).

If you have multiple locations that require different credentials, the Traffic Managers in the different locations do not need to be clustered. If, however, you want to cluster them, you must use the Traffic Manager's Multi-Site Manager functionality.

To enter your OSPFv2 or BGP credentials, use the **System > Fault Tolerance** page.

For further details about OSPFv2/BGP configuration and RHI traffic IP group configuration, see [Traffic IP Groups and Fault Tolerance](#)

Troubleshooting RHI Issues

The Traffic Manager uses third party routing software for RHI operations. This routing software logs RHI events to a specific file in your file system: `$ZEUSHOME/log/routing_sw`

The contents of this file are included in your Technical Support Reports (see [Getting Help](#)) and can be useful to your support provider in troubleshooting RHI communication problems in your Traffic Manager deployment.

This log file is subject to the following rotation policy:

- For Virtual Appliance and Cloud instances, the Traffic Manager performs log rotation automatically using a fixed file size (50 MB by default). Archived logs are compressed with the "gzip" compression method and stored under a name containing the date and a sequential number.
- For software instances, you must enact your own rotation policy. To inform the Traffic Manager that the log file has been rotated (moved), use the script `$ZEUSHOME/zxtm/zebos/bin/reload_logfile` post-rotation to restart the logging process in a new file.

An Introduction to OSPFv2 and BGP

The Traffic Manager supports Open Shortest Path First version 2 (OSPFv2) and Border Gateway Protocol (BGP) as routing protocols for RHI.

OSPFv2 is an "interior gateway protocol", typically used to distribute routes inside a single Autonomous System (AS) on a network, for example, with ISPs or large company networks. OSPFv2 enables routers to auto-discover and synchronize with other OSPFv2-configured routers in the same AS.

OSPFv2 works at Layer 3, using raw IP packets rather than over TCP or UDP, using a Time-To-Live (TTL) value of 1. It uses multicast addressing to flood routing information to the next router in the chain, and it is able to handle its own error detection and correction. OSPFv2 is typically internal to a body such as an ISP and is quick to converge (when a route changes, convergence is achieved when all routers in a network agree the new quickest route).

For further information on OSPF, see http://en.wikipedia.org/wiki/Open_Shortest_Path_First.

BGP is, by comparison, an exterior gateway protocol, typically used to distribute routing and reachability information outside of individual AS's.



BGP can still be used as an interior gateway protocol. For this purpose, the Traffic Manager uses Internal BGP (known as iBGP) for information exchange. For communication between routers in different ASs, the Traffic Manager uses External BGP (known as eBGP).

Unlike OSPFv2, rather than being able to auto-discover their peers, BGP enabled routers require you to define the explicit configuration of the neighbors with which they expect to establish sessions.

For further information on BGP, see www.bgp4.as.

You can configure the Traffic Manager to use either, or both, of these protocols to advertise IP addresses and to have these advertisements propagate through the network. To enable and use Route Health Injection with your services, see [Creating a Traffic IP Group](#).

Introduction to IPv6

IPv6 is a network layer protocol used in switching-packet networks. The main characteristic of IPv6 is the large amount of available addresses, as it uses 128 bits-long addresses instead of the 32 bits length provided by IPv4. It also simplifies the network management avoiding the use of complex subnetting schemes.

Some of the advantages provided by IPv6 are:

- IP security
- Mobile IP addresses
- Simplified header structure
- Address auto-configuration
- Anycast (one address out of many) and mandatory multicast addresses

Main Features of IPv6 in the Traffic Manager

The Traffic Manager provides the following aspects of IPv6 support:

- The Traffic Manager acts as a gateway for IPv6
- The Traffic Manager can process different IP address versions at your front end and back-end servers
- The Traffic Manager is able to work in IPv4-IPv6 mixed-networks, and in just-IPv4 networks

IPv6 unicast addresses can be used for configuring your Traffic Manager wherever IPv4 addresses can be used: in traffic IP addresses (excluding RHI and multi-hosted traffic IP addresses), when specifying nodes or the addresses a virtual server is listening on, in TrafficScript rules, and so on.

Your Traffic Manager can also function as a gateway from IPv4 to IPv6 or vice versa and even both at the same time.

Technical Restrictions

Some restrictions apply when using IPv6 in the Traffic Manager environment. Although they should not affect the normal running of the software, these restrictions must always be taken into account.

This is a list of the main restrictions regarding the use of IPv6:

- The internal communication between different Traffic Managers is done over the IPv4 protocol.
- Heartbeat messages only work on IPv4, as does the administration server.
- When using a hostname in the configuration of a back-end node, the Traffic Manager will first look up the IPv4 address. If you want to use the IPv6 address of a machine where the DNS has both IPv4 and IPv6 addresses, you must enter the IPv6 address directly.
- If a host has only an IPv6 address in the DNS, that address will be used.

Tuning Duplicate Address Detection



This section applies only to the Traffic Manager software variant. Traffic Manager hardware appliances, virtual appliances, and cloud variants are automatically configured with Duplicate Address Detection correctly tuned.

The Duplicate Address Detection (DAD) feature of many operating systems seeks to ensure that two machines do not raise the same address simultaneously. This feature can conflict with the Traffic Manager's fault tolerance; when an IP is transferred from one Traffic Manager system to another, timing conditions may trigger DAD on the Traffic Manager that is raising the address. The DAD feature can be tuned as follows:

- Linux: the sysctls are called `net.ipv6.conf.default.dad_transmits` and `net.ipv6.conf.all.dad_transmits`. Add (or change) these lines in `/etc/sysctl.conf` to:

```
net.ipv6.conf.default.dad_transmits = 0
```

and:

```
net.ipv6.conf.all.dad_transmits = 0
```

For immediate change, issue this command for each relevant interface (eth1 in this example), plus "default" and "all":

```
# sysctl -w net.ipv6.conf.eth1.dad_transmits=0
# sysctl -w net.ipv6.conf.default.dad_transmits=0
# sysctl -w net.ipv6.conf.all.dad_transmits=0
```

Initial Configuration

This chapter explains how to set up a basic traffic-managed site.

Architecture Concepts

A Traffic Manager manages traffic for network services like Web and application servers (HTTP, HTTPS), Web services (SOAP), mail (SMTP, POP, IMAP) and other protocols such as DNS and streaming media.

A "service" is published as an IP address and port, and accepts traffic using the appropriate protocol.

A website might be hosted at `www.example.com`. This website name is then mapped through DNS to resolve to an IP address, and you configure your Traffic Manager service to listen on that IP address for a particular traffic type on the corresponding port (for example, HTTP traffic on port 80).

For example, an Internet Service Provider (ISP) publishes its POP3 and SMTP mail servers as `pop.example.com` and `smtp.example.com`. Each of these servers has a DNS entry linking it to an IP address:

- `pop.example.com` has address 192.0.2.150
- `smtp.example.com` has address 192.0.2.151

`pop.example.com` listens on port 110 for POP3 traffic, while `smtp.example.com` listens on port 25 for SMTP traffic.

Within a Traffic Manager, all the traffic for a particular service is handled by a "virtual server". This is the interface between a Traffic Manager and the Internet, and is set up for a specified port and protocol; typically, it will manage all the traffic for that protocol.

When the virtual server receives a request, it assigns it to a "pool". This is a collection of "nodes", each corresponding to a back-end server and port, such as `server1.example.com:80`. The pool load-balances traffic across the nodes. You can set up several pools, which might have nodes in common.

To decide which pool to use for a request, the virtual server can apply a list of "rules". A rule inspects the incoming request, and decides what action to take with it. It can choose a pool to handle the request, close the request, or pass the request on to the next rule in the list. If no rule makes a positive routing decision, the request is assigned to the virtual server's "default pool".

If a node in the pool should fail, the Traffic Manager's "monitors" detect this automatically. Consequently, the Traffic Manager stops sending requests to that node. Traffic is distributed among the other nodes in the pool with no visible disruption to the service.

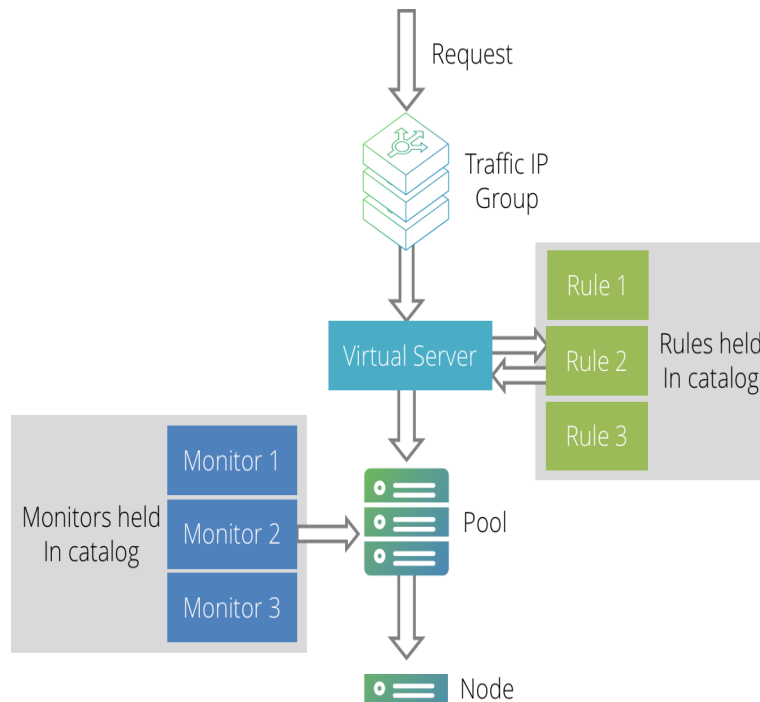

A Traffic Manager machine can run many virtual servers, one for each service it manages. Each virtual server can use several rules and pools, and various monitors can watch the pools.

Rules and monitors are organized into “Catalogs”. The Rules Catalog, for instance, holds all the rules which have been written for the system. A rule in the catalog can be applied to any virtual server easily. Other shared items, such as SSL certificates and service protection classes, are also held in catalogs.

Two or more Traffic Manager machines can be arranged in a “cluster”. Configuration is shared across all the Traffic Manager machines in the cluster; each machine runs the same virtual servers, using the same rules, and so on.

The public traffic IP addresses used for your services can be arranged into “traffic IP groups”. A traffic IP group spans some or all of the Traffic Managers in the cluster, and these Traffic Managers host the group’s IP addresses between them. If a Traffic Manager machine should fail, one of the other machines in its traffic IP group raises its IP address. This, with the pools’ failover system, gives full fault-tolerance for both front ends and back ends.

While a Traffic Manager is running, hostnames are re-resolved at regular intervals, usually of no more than 5 minutes. This provides an efficient re-resolving of nodes whenever the DNS changes.

Managing Your First Service

To begin managing your first service, create a virtual server and a default pool. There are two ways to do this: using the "Manage a New Service" wizard or the "Configure" pages.

Browse to the Web address of the Admin UI of your fully configured Traffic Manager. Log in with your username and password.



For full details of how to install and configure the Traffic Manager, see the Pulse Secure Virtual Traffic Manager: Installation and Getting Started Guide for the product variant you are using.

Using the Wizard to Create a Virtual Server and Pool

Click the "Wizards" drop-down menu and select **Manage a New Service**. Step through the instructions that follow.

1. Specify a name that you will use to identify the virtual server. Choose a protocol and port for the virtual server (e.g. HTTP, port 80).

Manage a new Service, step 2 of 4

2. Specify the service

Please enter a brief name to identify the service you would like to balance.

Name:

Please select the protocol that the service uses.

Protocol:

Please specify the port that the protocol listens on.

Port:

Cancel

◀ Back

Next ▶

2. Create a list of back-end nodes, which will form the default pool for the virtual server. The nodes are identified by hostname and port. You can modify them later from the **Pools > Edit** page (see [Pools](#)). You should ensure that you can serve content directly from the hostname-port combinations you specify.

Manage a new Service, step 3 of 4

3. Specify the back-end nodes

Please enter the hostname and port of each node:

Hostname: Port:

Nodes:

```
server1.mysite.com:80
server2.mysite.com:80
server3.mysite.com:80
```

To remove a node from the list, select it and press 'Remove node':



If, for evaluation purposes, you are running a Traffic Manager on the same machine as your web server (or other test server), you need to make sure the two services are listening on different ports.

For example, suppose you are managing traffic to a Web server. The default HTTP port is 80; so you might have the Web server listening on port 8080 and the Traffic Manager listening on port 80. This means that entering the machine name in a browser (such as `server1.mysite.com`) will send traffic via the Traffic Manager.

3. Review the settings you have chosen, then click **Finish**.
4. You can now test your Traffic Manager setup by browsing to the machine and port you set up for your new service.



Names for virtual servers, pools, error files, and so on, cannot begin with a period (`.`), an underscore (`_`), or a pound sign (`#`), and cannot end with a tilde (`~`).

Creating a Pool and Virtual Server Manually

Click the **Services** button on the top bar of the Admin UI. Use the Services pages to manage your virtual servers, pools, and Traffic Managers.

Creating a Pool

1. First you must create a pool of back-end servers. Click the **Pools** tab and fill in the details in the "Create a New Pool" section.

Choose a name for the pool, and enter a list of nodes (unless you enable Autoscaling, in which case no nodes are required). Each node should be listed in the form "server1.mysite.com:80", where 80 is the port "server1" is listening on. The nodes should be separated by spaces:

```
s1.mysite.com:80 s2.mysite.com:8080 s3.mysite.com:80
```

2. Click **Create Pool**. You will be taken to the **Pools > Edit** page for your new pool, where you can edit its basic and more advanced settings.

Creating a Virtual Server

1. Click the **Virtual Servers** tab to create a new virtual server. You must specify a name, a protocol, and the port the virtual server is to listen on. If you are installing the Traffic Manager and your server software on the same machine, note the comment about port numbers in the previous section.

You must select a default pool for the virtual server. Requests will be assigned to this pool unless a rule specifies another pool or action.

2. Click **Create Virtual Server**. You are taken to the **Virtual Servers > Edit** page for your new virtual server, where you can edit basic and advanced settings. These include the IP addresses (specified by domain name or address) the virtual server listens on.

Creating a Cluster

The Traffic Manager is often deployed as clusters of two or more instances for fault tolerance (see [Traffic IP Groups and Fault Tolerance](#)) and management reasons. All of the Traffic Managers in a cluster share the same service configuration and are managed as a single entity.

- System-specific settings, however, such as network configuration remain unique to each cluster member and must be managed individually.

You can join Traffic Manager systems together to form a cluster using one of the following methods:

- To create a new Traffic Manager cluster from scratch, choose one Traffic Manager as the first cluster member. Then, log in to the admin UI on each of your other Traffic Managers in turn, and use the "Join a cluster" wizard to join with the first Traffic Manager.
- To join an existing Traffic Manager cluster, login to the Admin UI on each new instance and use the "Join a cluster wizard" to join each of these with the existing cluster.

In a cluster, all Traffic Managers are considered equal. You can access the Admin UI on any of your Traffic Managers, and the configuration changes you make are automatically replicated across the cluster. All of the Traffic Managers function together to provide fault tolerance and simplified management.

- During a software upgrade, only one Traffic Manager should be used to update the entire cluster at a time. This helps prevent multiple concurrent updates potentially corrupting the automatic configuration replication mechanism. For more information on upgrading, see the Pulse Secure Virtual Traffic Manager: Installation and Getting Started Guide applicable to your product variant.

Joining a Cluster

Log in to the Admin UI on one of your Traffic Managers and select **Join a cluster** from the "Wizards:" drop down box in the tool bar.

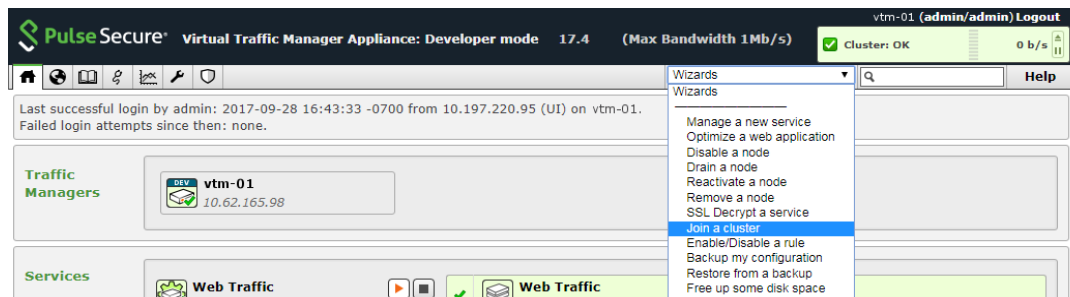

The Cluster Joining wizard starts in a separate pop up window.

Cluster Joining wizard, step 1 of 5**1. Getting Started**

This wizard joins your current traffic manager to an existing cluster so that it can share the cluster's configuration and traffic.

Joining a new cluster will remove this traffic manager from its current cluster.

Would you like to select an existing cluster from a list of available clusters on your network, or enter the Administration Server address and port of a specific traffic manager to join?

- Select existing cluster
 Manually specify host/port

Cancel ◀ Back Next ▶

To instruct the Traffic Manager to automatically scan the network for contactable Traffic Managers, click "select existing cluster". Alternatively, to enter a specific hostname and port you want to join, click "Manually specify host/port". Click **Next** to continue.

The next step reflects the choice you made in **Step 1**. If you clicked "select existing cluster", the Traffic Manager presents a list of discovered Traffic Manager instances and clusters.

Cluster Joining wizard, step 2 of 5**2. Cluster selection**

Please select the cluster you wish to join:

- Cluster 1: aknox-02.cam.zeus.com:9092
 Cluster 2: apritchard-12.cam.zeus.com:9090
 Cluster 3: coeus.cam.zeus.com:9090
 Cluster 4: fry:9090
 Cluster 5: rkistruck-2b:9090 rkistruck-2d.cam.zeus.com:9090
 Cluster 6: jmoore-01:9090
 Cluster 7: jsteele-00.cam.zeus.com:9090 jsteele-04.cam.zeus.com:9090

Cancel ◀ Back Next ▶

If you clicked "Manually specify host/port", enter your hostname and port number in the boxes provided.

Cluster Joining wizard, step 2 of 5

2. Cluster selection

Please provide the admin server host and port of one of the machines in the cluster you wish to join:

Hostname:

Port:

Click **Next** to continue.

To connect to the specified instance or cluster, you must verify the identity of the Traffic Managers within the cluster, and provide the administration credentials used by the cluster.

Cluster Joining wizard, step 3 of 5

3. Authentication

The admin server you are clustering with is using an SSL certificate with the following SHA-1 fingerprint:

10.62.165.97:9090 B6:35:68:29:76:56:15:C0:FF:76
69:89:DA:30:7A:DB:02:60:2A:89

▶ **Unfold to view full certificate details ...**

Please check the box beside the fingerprint above to indicate that you have verified it or that you trust the network between it and this system.

If you do not already have this fingerprint on record you can get it by logging into the target admin server and visiting the **System > Security** page. (Refer to the product documentation for further information on cluster security.)

Enter the username and password of a user in the target cluster with permission to add and remove traffic managers.

Username:

Password:

Ivanti recommends that you verify the identity of each Traffic Manager in the cluster you want to join. To verify a Traffic Manager's identity, check the displayed SHA-1 fingerprint against the fingerprint shown in the target Traffic Manager's Admin UI, in **System > Security**.

Tick the checkbox next to each Traffic Manager hostname to confirm you trust its identity, and then enter the cluster admin username and password. Click **Next** to continue.

Check your settings and click **Finish** to join the cluster. The Traffic Manager software reconfigures itself and presents a new home page showing all connected Traffic Manager instances in the Traffic Managers list.

To add further Traffic Managers to the cluster, run the "Join a cluster" wizard on the Admin UI of each Traffic Manager you want to add.

If you want to join a Traffic Manager to an existing cluster, but the cluster does not appear in the list in the wizard, check your network configuration and cabling and ensure that the network permits multicast and broadcast packets.

Joining Clusters with Traffic IP Groups

If the cluster already has one or more Traffic IP groups configured, the wizard can add the new Traffic Manager to these Traffic IP groups so that it starts handling traffic immediately.

However, this is likely to result in a number of connections being dropped at the instant the new Traffic Manager is added to the Traffic IP group, because allocations of traffic need to be transferred to the new Traffic Manager. In this case, you can select to add the new Traffic Manager as a "passive" member of the Traffic IP group. It does not accept any traffic until another member of the group fails.

Virtual Servers

This chapter describes the concept of a virtual server, a configuration object used to represent the interface between a Traffic Manager and the Internet.

Introduction

A virtual server manages all the traffic for a specified port and protocol. It can apply rules to decide which pool should handle a request, and can decrypt SSL traffic if required.

The Traffic Manager supports a wide range of protocols. Specialized handlers are provided for complex protocols such as HTTP, RTSP and SIP, and the software can load-balance TCP connections and UDP sessions using the “Generic” protocol versions. Details about the protocol support available can be found in [Protocol Support](#)

To view a list of your virtual servers, click **Services > Virtual Servers**. Click the name of an existing virtual server to modify its settings, or create a new virtual server using the “Create a new Virtual Server” section.

Using Virtual Servers

Generally, you should plan to run one virtual server for each distinct service you are running. That is, each TCP or UDP port you are accepting traffic on.

For example, you should run one virtual server for HTTP, irrespective of how many distinct Web sites you are running on port 80. This differs from the way you might configure a Web server, where you configure one virtual server for each distinct Web site. If you need subtly different traffic management configurations for each Web site, these can be implemented using TrafficScript to control how the traffic is managed.

A typical Traffic Manager installation might only have 5 or 10 virtual servers configured. If you anticipate having more than 100 virtual servers, you should plan to manage your Traffic Manager system using the programmatic Control API (see [The Traffic Manager Control API](#)) or REST API (see the *Pulse Secure Virtual Traffic Manager: REST API Guide*) rather than the Web-based Admin UI.

Selecting a Protocol

When you configure a virtual server, you need to specify the protocol of the traffic it is handling. The protocol value is the internal protocol used within the Traffic Manager to parse and interpret the traffic. Choose the most appropriate protocol setting for the traffic you are managing.

The “Generic Server First”, “Generic Client First” and “Generic Streaming” protocols are simple TCP protocol handlers that process TCP connections, forwarding data between clients and servers. The three protocols differ as follows:

- When the Traffic Manager receives a connection on a ‘Generic Server First’ virtual server, it immediately runs any TrafficScript rules, makes a load-balancing decision and connects to a back-end server. It then relays data bi-directionally between the client and the server.

This selection is appropriate for protocols where the server application writes a “handshake” or “banner” message when the client application connects, before the client writes any data to the server.

- When the Traffic Manager receives a connection on a “Generic Client First” virtual server, it does not process the connection until some data has been received from the client. The Traffic Manager then runs TrafficScript rules, makes the load-balancing decision, connects to the selected back-end server and writes the data previously received from the client. The Traffic Manager then relays data bi-directionally between the client and the server.

This selection is appropriate for protocols where the server expects the client to initiate the dialog by writing data first.

- The “Generic Streaming” protocol resembles Generic Server First, however is an appropriate choice where the virtual server is expected to handle non-request/response data originating from either the client or the back-end server. The Traffic Manager runs associated TrafficScript rules each time, makes a load-balancing decision and then relays data bi-directionally between the client and the server.

This selection is appropriate for protocols where the server or client may initiate the dialog, but not automatically expect a response to any data received.

These generic protocols are the foundation that other TCP protocol handlers are built upon. The generic protocols allow you to inspect and rewrite request and response data and synchronize the communications between the client and the server, but only at a very low level.

The other TCP protocol handlers in the software are specialized for particular protocols – FTP, HTTP, and so on. When you select a more specialized protocol such as HTTP, the following conditions are true:

- Additional protocol-specific options are made available in the configuration of the virtual server and pool, such as “keepalive” settings for HTTP or security settings for FTP.
- The Traffic Manager parses messages in that protocol and allows you to use additional TrafficScript functions to manage the request and response data more easily; helper functions to read and set Cookies in an HTTP transaction, for example.

You can use the appropriate basic “Generic” protocol handler when you are processing a high-level protocol such as HTTP. If you do so, you will be unable to use the specialized handling for that protocol.

A virtual server also supports traffic over UDP. You can select either basic UDP (for a simple UDP request-response protocol such as DNS) or UDP streaming (where the server may send a limitless number of UDP packets in response to a request).

Refer to [Protocol Support](#) for more details about specific protocol support.



If the Traffic Manager decrypts SSL-encrypted traffic, references to protocol refer to the protocol of the decrypted traffic. For example, if the Traffic Manager is receiving HTTPS traffic on port 443 and uses SSL decryption to decrypt it, then the protocol in use within the Traffic Manager is HTTP.

Applying Rules

A virtual server examines a request using TrafficScript rules to choose an action to take. Each rule examines the request, possibly modifies it, and performs a final action:

- Choose a pool to handle the request.
- Close the request.
- Log the transaction.
- Do nothing; the request is passed to the next rule in the list.

Each virtual server is associated with a “default pool”. If no rule makes a positive routing decision, the request is assigned to this pool.

A rule can also selectively enable or disable features in the Traffic Manager for that specific connection. For example, a rule can specify that the request should use a particular session persistence class, or that the response should not be cached.

Rules are constructed using Ivanti's TrafficScript language. This has the capability to inspect all aspects of the incoming request, from the source and destination port and IP to the type and actual content of the traffic. TrafficScript incorporates support for XPath (a language used to query XML documents), XSLT, and other XML-specific capabilities. These are often used by SOAP-based protocols employed by Web services, and enable complex data to be exchanged and understood automatically without user intervention.

Rules are applied in the order that you specify. You can apply rules to each incoming request, to each outgoing response, and at the completion of a transaction.

Create your rules in the rules catalog (see the **Catalogs > Rules** page of the Admin UI) and apply them through a virtual server. Any virtual server can use any rule from the catalog.

To add a rule to your virtual server, go to the applicable **Virtual Servers > Edit** page and click **Rules**. For request rules, use the "Request Rules" section. Likewise, for response and transaction completion rules, use the "Response Rules" and "Transaction Completion Rules" sections, respectively. Select a new rule to add from the drop-down box in the desired section, then click **Add Rule**.

The rules for your virtual server are shown in a list, and are applied in the order shown. Move a rule up or down the list using the grab handle to the left of each rule bar. Using the mouse pointer, drag and drop the rule to the new position you want it to be in; the Traffic Manager reorders the list automatically. If you have only one rule, no grab handle is displayed, and you cannot drag rules between sections.

You can disable a rule in the list to temporarily stop it from being executed, and re-enable it to make it active again.

For non-HTTP protocols that conduct a lengthy dialog with many requests and responses in one connection, you can choose whether a rule should be run "once" (just against the first request) or against "every" request. [TrafficScript Rules](#) covers creating and applying rules in more detail.

The TrafficScript language is documented in a dedicated reference guide, available from the Ivanti Web site at: www.ivanti.com

SSL Decryption

A virtual server can decrypt SSL traffic. This can be useful for two reasons:

1. After decryption, a rule can analyze the request's headers and contents to make an informed routing decision. Without decrypting the packets very little information is available.

2. Decrypting requests requires processing power. It may be more efficient if the Traffic Manager decrypts requests before passing them on to the nodes, reducing the load on the back-end servers.

If traffic is decrypted in order to apply rules, you may wish to re-encrypt it before sending it on to the back ends. Re-encryption is handled by the pools (see [SSL Encryption](#)).

To set up a virtual server to decrypt SSL traffic, go to the **Virtual Servers > Edit** page for that virtual server and click **SSL Decryption**. You can choose whether to decrypt traffic, and which certificate from the SSL Certificates Catalog to use. You can also configure the allowed cipher suites and the SSL or TLS (Transport Layer Security) versions for each virtual server.

You can also choose whether to request an SSL client certificate. These serve to identify the client, and you can use them to restrict access to only those individuals you choose.

The Traffic Manager can also check client certificates using OCSP (Online Certificate Status Protocol). OCSP is an alternative to Certificate Revocation Lists (CRLs) and allows the Traffic Manager to obtain the revocation status of a client certificate. Clients making TLS connections can request that the virtual server supply status information for the server's certificate as part of the TLS handshake. Enable "OCSP Stapling" to instruct the Traffic Manager to retrieve the necessary OCSP responses and include them in its handshake messages.

The Traffic Manager's SSL capability is described in detail in [SSL Encryption](#).

Decrypting SSL Pass-Through Traffic

Recall that the protocol value for a virtual server refers to the internal protocol that the Traffic Manager is managing, after performing transformations such as SSL decryption.

If the protocol value for the virtual server is set to "SSL", this indicates that the virtual server is just forwarding SSL traffic in SSL pass-through mode. If you want to configure SSL decryption, you must first change the protocol value to the correct value for the internal protocol (for example, HTTP). In this case, your pools are probably sending traffic to nodes which expect SSL encrypted traffic, so you will also need to configure SSL encryption in the pools.

You can use the "SSL Decrypt a Service" wizard to configure an SSL pass-through service to decrypt traffic in the virtual server, and re-encrypt it in the pool. This wizard is described in [SSL Decryption Wizard](#).

Note that only some protocols support SSL decryption. SSL decryption is not available for UDP based protocols, or for protocols that cannot be automatically wrapped with SSL such as SIP.

Service Protection Classes

A “service protection class” is a group of settings you specify to protect your service against malicious attacks, such as Denial of Service (DoS) and Distributed Denial of Service (DDoS). You can create a service protection class in the Service Protection Catalog, and configure settings such as:

- Lists of banned and trusted IP addresses. Connections from these IP addresses are never allowed and always allowed, respectively.
- Limits on the number of connections from one machine or a group of machines.
- A limit on the connection rate from any one IP address.
- Restrictions on HTTP requests, such as whether they should be strictly RFC2396-compliant.

You can apply a service protection class to a virtual server by clicking the **Classes** link on the appropriate **Virtual Servers > Edit** page. In the Service Protection section, select a class from the list and click **Update**.

Service protection is covered in detail in [Service Protection](#).

Bandwidth Management Classes

A “bandwidth management class” defines a bandwidth limit that virtual servers can apply to data sent to clients. For example, if several large download connections were assigned a shared limit bandwidth class of 250Kbits, these connections could not consume more than this limit.

You can apply a bandwidth management class to a virtual server by clicking the **Classes** link on the appropriate **Virtual Servers > Edit** page. In the Bandwidth Management section, select a class from the list and click **Update**. This will have the effect of limiting all the traffic the virtual server manages to the defined value in the class, according to the limit sharing type specified (per-connection, per-machine, or cluster-wide).

Bandwidth Management is covered in detail in [Bandwidth Management](#).



Bandwidth Management is not available on all Traffic Manager configurations. If required, it can be obtained via a software or license key upgrade.

Service Level Monitoring Classes

“Service Level Monitoring (SLM) classes” are used to monitor the level of service (response time) that end users of the service are receiving. An SLM class defines a desired response time. It also defines percentage tolerance limits; if the percentage of requests that meet the desired response time falls below these limits, an alert or log message is raised.

You can apply a service level monitoring class to a virtual server by clicking the **Classes** link on the appropriate **Virtual Servers > Edit** page. In the Service Level Monitoring section, select a class from the list and click **Update**. This will cause the virtual server to monitor and log the response times for all of the connections it manages, and raise log+ messages or alerts in the event of service level problems.

Service Level Monitoring is covered in detail in [Service Level Monitoring](#).



Service Level Monitoring is not available on all Traffic Manager configurations. If required, it can be obtained via a software or license key upgrade.

HTTP Content Caching

A Traffic Manager HTTP virtual server can detect commonly requested HTTP resources, and remember their content if it does not change each time it is requested. This capability is called “Content Caching”.

When the virtual server sees subsequent requests for the same resource, it can return the content for the resource directly from the local cache, rather than forwarding the request on to a (possibly overloaded) back-end server. This capability reduces the load on the back-end servers and improves the performance and capacity of your HTTP services.

Clicking the **Content Caching** link on the **Virtual Servers > Edit** page shows you the settings for content caching. You can enable the content caching capability, and specify how long various types of content are cached for. Content caching is only available for HTTP virtual servers, and for virtual servers accepting and decrypting HTTPS traffic.

Content Caching is described in detail in [Content Caching](#).



HTTP Content Caching is not available on all Traffic Manager configurations. If required, it can be obtained via a software or license key upgrade.

Web Accelerator

Ivanti Web Accelerator (Web Accelerator) provides optimization technology for your Web content. It automatically optimizes Web page markup and elements, such as HTML code, images, scripts, and custom style sheets, so they load faster for end users. Reducing Web page load time is vital to improving end user experience.

Where possible, versions of these optimized elements are internally cached for an even quicker response to subsequent requests. These accelerated Web pages are faster to load and can also save on data traffic and server infrastructure, thanks to better bandwidth utilization.

To enable Web Accelerator for your services, click the **Web Accelerator** link on the **Virtual Servers > Edit** page. Note that this facility is only available for your HTTP virtual servers.

For full details on Web Accelerator settings, see [Using Pulse Secure Web Accelerator](#).



Web Accelerator functionality is not available as standard on all Traffic Manager configurations. If you require Web Accelerator, contact Ivanti Support for a software or license key upgrade.

HTTP Content Compression

The Traffic Manager can compress an HTTP response when it sends it to the remote client. This can reduce your bandwidth usage, and speed up the delivery of large Web pages to clients with slow connections.

Not all browsers can receive compressed content; those which do specify this in the HTTP request headers. The Traffic Manager compresses content only for those browsers which are able to decompress it.

Some Web servers are also able to compress content, so it may be more efficient to spread this work across your Web servers instead of using the Traffic Manager for this purpose. However, enabling compression on both should not cause any problems.

Clicking the **Content Compression** link on the **Virtual Servers > Edit** page shows you settings for content compression. You can choose whether to enable compression; which MIME file types to compress; and the size of documents that should be compressed.

If you offer large files for download from your site, it may be sensible to pre-compress them rather than have a server do this each time they are requested.

Controlling Content Compression

The Traffic Manager can compress HTTP responses if the request contains an "Accept-Encoding: gzip" header. The Traffic Manager checks the request before and after running TrafficScript rules; if the header is present in either case, the Traffic Manager will compress the content.

For example, you can configure a rule to remove the Accept-Encoding header from a request. In this case, the back-end server will never send a compressed response (because it never sees the header), but the Traffic Manager will compress the response from the back-end server if the remote client supports compression. This technique can be used to offload all compression tasks from the back-end server onto the Traffic Manager.

You can also control whether the Traffic Manager compresses content using the `http.compress.enable()` and `http.compress.disable()` TrafficScript functions.

Connection Analytics

To facilitate efforts in tracing and debugging traffic to your services, the Traffic Manager can display full details about each connection handled by a virtual server.

To enable this feature for a virtual server, click **Services > Virtual Servers > Edit > Connection Analytics**.

The following table contains details of the connection analytics configuration options available to a virtual server:

| Configuration Option | Description |
|------------------------------------|--|
| <code>recent_conns!enabled</code> | Enable this setting to ensure connections handled by this virtual server are shown on the Activity > Connections page. |
| <code>recent_conns!save_all</code> | Select whether to show or hide, by default, all connections handled by this virtual server on the Activity > Connections page. You then override this behavior for individual connections using TrafficScript. Set to "No" to hide all connections by default, and then use the TrafficScript function <code>recentconns.include()</code> to selectively include connections in your rules. |

| Configuration Option | Description |
|---------------------------------------|---|
| | <p>Set to "Yes" to show all connections by default, and then use the TrafficScript function <code>recentconns.exclude()</code> to selectively exclude connections in your rules.</p> <p>For more details about these functions, see the TrafficScript Reference in the Online Help, or the <i>Pulse Secure Virtual Traffic Manager: TrafficScript Guide</i> available from the Ivanti Web site at www.ivanti.com.</p> |
| <code>request_tracing!enabled</code> | <p>Enable this setting to instruct the Traffic Manager to collect detailed data on internal events connected to each request and response. This data includes the time that each request is received by the Traffic Manager and when each TrafficScript rule is run.</p> |
| <code>request_tracing!trace_io</code> | <p>If <code>request_tracing!enabled</code> is set to Yes, use this setting to enable the collection of data on individual read and write events for this connection.</p> |

Viewing Connection Analytics

Use the **Activity > Connections** page to interrogate each individual request in detail. Click the magnifying glass icon next to each connection to view specific details. For more information, see [Activity > Connections](#).

Exporting Transaction Metadata

Your Traffic Manager cluster can export metadata records for transactions handled by your virtual servers as a JSON stream to an external endpoint such as an analytics service or dashboard. Use these settings to disable or limit analytics exporting for specific virtual servers, and thus to limit the overall volume of data exported by the Traffic Manager.

Before the Traffic Manager can start exporting transaction metadata, first configure the destination endpoint and other global settings your cluster should use. For more information, see [Exporting Analytics to a Remote Service](#).

To configure the parameters this virtual server uses when exporting transaction metadata records, use the **Virtual Server > Edit > Connection Analytics > Transaction Metadata Export** section. The following table lists the available settings:

| Key | Description |
|----------------------------|--|
| transaction_export!enabled | <p>Instructs the Traffic Manager to export metadata records for transactions handled by this virtual server.</p> <p>Use this setting to isolate out the services for which you do not want to export transaction metadata from those that you do. For all virtual servers in scope, ensure the corresponding transaction_export!enabled key is set to "Yes". For all virtual servers out of scope, set to "No".</p> <p>The Traffic Manager contains a global transaction_export!enabled key that overrides all individual virtual server settings. Use this global key to fully disable analytics exporting across your cluster. For more information, see Configuring Export Settings for Transaction Metadata Records.</p> |
| transaction_export!brief | <p>Enables "brief" mode for transaction metadata records.</p> <p>The JSON schema for transaction metadata (see link in System > Analytics Export > Transaction Metadata) shows the full set of data included in each record exported by the Traffic Manager. The full record includes verbose information such as HTTP request and response header data, and detailed information about the TLS session if one was negotiated. To reduce the volume of data exported in each metadata record, use brief mode to configure the Traffic Manager to instead provide just a limited set of properties.</p> |

| Key | Description |
|---|--|
| | <p>Where transaction_export!brief is disabled, the Traffic Manager includes request tracing and I/O tracing information in the exported metadata only if request_tracing!enabled and request_tracing!trace_io are enabled respectively. If transaction_export!brief is enabled, request tracing information is always excluded from the exported metadata.</p> |
| <p>transaction_export!http_header_blacklist</p> | <p>The list of HTTP headers that the Traffic Manager should exclude from exporting.</p> <p>Use this setting to exclude headers that might contain sensitive information such as passwords, or to reduce the exported data size where headers are not required for analysis.</p> <p>For more complex or conditional filtering, use TrafficScript to create a Transaction Completion Rule to alter the headers before they are recorded. For more information, see Applying Rules.</p> |
| <p>transaction_export!hi_res</p> | <p>Enables high resolution mode for the connection timeline.</p> <p>Use this setting to control whether the Traffic Manager records the connection timeline with high resolution (in microseconds) or with low resolution (in milliseconds).</p> <p>High resolution gives a more accurate portrayal of processing time, but can have a small impact on the latency of each connection handled.</p> |

Perform this configuration for each virtual server whose transaction metadata records you want to export. Disable **transaction_export!enabled** for all other virtual servers to ensure you export data for only the services you want to analyze.

To fully disable transaction analytics exporting from the Traffic Manager cluster without having to reconfigure each virtual server separately, use the settings at **System > Analytics Export**. For more details, see [Configuring Export Settings for Transaction Metadata Records](#).

Request Logging

Use this page to store detailed logs of the requests handled by your virtual server. You can write the logs to a local file on your Traffic Manager or to a syslog daemon running on a remote machine, according to the protocol described in RFC 5424. You can enable request logging for a virtual server by clicking the **Request Logging** link on the appropriate **Virtual Servers > Edit** page.

You can set the default logging behavior using the **log!save_all** setting. Set to "Yes" to instruct the Traffic Manager to log all connections by default. You can then use the TrafficScript function `requestlog.exclude()` inside a rule to exclude specific connections from the log. Set to "No" to instruct the Traffic Manager to not log connections by default. You can then use the TrafficScript function `requestlog.include()` in a rule to select specific connections to be included in the log. Click **Update** to apply your settings.

Request Logging to a File

You can specify a filename and log entry format, with details such as the IP addresses involved, the pool and node involved, and the bytes sent and received. You can also set HTTP-specific options such as the URL requested, the value of a specified header, and the HTTP method.



Unlike other logs, request logs are not synchronized across your cluster. Each Traffic Manager maintains its own log files.

To log requests to a file, set **log!enabled** to "Yes" and specify the filename for the log. Click **Update** to apply your settings.

Logs can be automatically rotated so that each log does not grow too large. Use a `%{Time-String}t` macro in the filename; this macro expands to the current time or date.

For example, the macro `%{%Y%m%d}t` expands to a value like 20161020 (for October 20, 2016). This will cause the log files to be automatically rotated at midnight as the value of the macro changes.

On virtual appliance and cloud instances of the Traffic Manager, log file naming and rotation is handled automatically:

- The log files are checked hourly.
- Any file that reaches 1 GB is archived.
- After the cumulative size of all current log files reaches 6 GB, the largest logs are archived by decreasing size until the cumulative total drops below 6 GB.

- All remaining logs are archived daily.

After the log directory reaches 85% of capacity, the Traffic Manager starts to delete the oldest files from the largest directories.

Viewing Request Logs

You can view request logs in real time by clicking the **View Request Logs** link. This redirects to the **Activity > View Logs** page, described in more detail in the [Activity > View Logs](#).

Remote Request Logging

The Traffic Manager can log requests to a remote syslog server, rather than to a file on a local disk. All Traffic Managers in the same cluster log traffic to the same syslog server.

To configure remote logging, set **syslog!enabled** to "Yes", specify an endpoint (IP address or host, and optional port), and select the log file format you want to use. Click **Update** to apply your settings.

The syslog protocol uses UDP, which is not guaranteed to be reliable. When traffic levels are particularly high on a busy or lossy network, there is the danger of log records being dropped.

Controlling Request Logging

Requests can be selectively logged. The TrafficScript function `request.setLogEnabled()` can be used to enable or disable logging for an individual request; if it enables logging, the settings in the **Request Logging** page are used to determine how the request is then logged (local log file or remote syslog server).

Protocol Settings

Use the **Virtual Servers > Edit > Protocol Settings** page to access advanced settings for managing connections between remote clients and your virtual server. These include the following:

| Type | Description |
|---------------|---|
| HTTP Settings | Keepalive settings, and whether the Traffic Manager should include headers in the request, such as "X-Forwarded-For", "X-Forwarded-Proto", and "X-Cluster-Client-Ip". |

| Type | Description |
|--------------------------|--|
| Cookie Settings | Specifies how the cookies are handled by the Traffic Manager. |
| RTSP Specific Settings | Allows user to define a specific range of ports to be used with RTSP (RTSP virtual servers only). For more details, see Real-Time Streaming Protocol . |
| SIP Settings | Specify how the Traffic Manager handles SIP traffic (SIP virtual servers only). For more details, see Session Initiation Protocol . |
| Location Header Settings | Allows URL redirection in case a node replies with a 301 (moved permanently) or 302 (temporary redirect) status code, using an incorrect protocol, hostname or port (HTTP virtual servers only). |
| FTP Settings | Security settings and port ranges for FTP data connections (FTP virtual servers only). |
| UDP Settings | Timeouts, and the maximum number of response datagrams expected for one connection (UDP virtual servers only). |
| Timeout Settings | Timeouts for new and established connections. |
| Error Handling | Allows the user to define how the virtual server handles errors on connections it processes. |
| Memory Limits | Maximum buffer sizes for data sent by the client and returned by the server. |
| TCP Connection Settings | <p>Use max_concurrent_connections to configure the maximum number of concurrent TCP connections allowed by this virtual server. When the configured limit is reached, the Traffic Manager does not accept new connections to this virtual server until the number of concurrent TCP connections drops below the specified limit.</p> <p>Enable proxy_protocol if the Traffic Manager should expect connections to be prefixed with a PROXY protocol header. Use TrafficScript to inspect the information contained in the PROXY header. Connections that are not prefixed with a valid PROXY protocol header are discarded.</p> <p>The Traffic Manager supports PROXY protocol versions 1 and 2.</p> |

| Type | Description |
|----------------------|--|
| | <p>Enable close_with_rst to instruct the Traffic Manager to close connections from clients with a RST (reset) packet rather than a FIN (finish) packet. This avoids the TIME_WAIT state, which on rare occasions allows wandering duplicated packets to be safely ignored. It also ensures data has been fully received by the peer. Enable this option only if you fully understand the implications of TCP state transition, since TCP connections typically finish with a FIN packet to the peer and an acknowledgment FIN packet in reply. This mechanism allows the sender to be sure the peer has read all the queued data, which cannot happen if the connection is closed with a RST packet. On an unreliable network, data that has been transmitted can in some cases be lost in transit. The purpose of the TIME_WAIT state is to prevent wandering delayed packets from one TCP connection using address <A>:<port P> to address :<port Q> from being accepted by a later TCP connection using the same addresses. In other words, if a duplicate packet from the first connection is delayed in the network and arrives at the second address when its sequence number is in the second connection's window, there is no way for the network stack in the kernel to determine that the delayed packet contains data from the first connection, potentially causing corruption. The kernel increments port numbers in use, so the possibility of this occurring is minimal but not zero.</p> <p>Enable proxy_close to send the client FIN to the back-end server and wait for a server response instead of closing the connection immediately.</p> <p>Enable so_nagle to improve the efficiency of the TCP connection by reducing the number of packets that have to be sent over the network.</p> |
| Transparent Proxying | <p>To enable transparent proxying for bound sockets on this virtual server, set "transparent" to Yes. In this configuration, a firewall rule can be used to send selected traffic to the virtual server without changing the destination address.</p> |

| Type | Description |
|------|---|
| | In a TrafficScript request rule, you can determine what course of action to take by checking the request's destination IP address or port by using "request.getDestIp" or "request.getDestPort". You can then perform forward proxying to the original destination using "pool.select". |

Settings specific to a certain protocol are only shown if the virtual server is managing that protocol.

You do not normally need to change any of these settings. The default values have been chosen to give good performance on a wide range of systems.

MIME Type Auto-Detection

The MIME Type is a component of an HTTP response that describes the type of data in the response – image, HTML page, and so on – so that the client can know how to render or process it.

Some Web servers and Web applications do not correctly set the MIME type response header, and most client software is capable of detecting when this has occurred and auto-detecting the MIME type itself.

In certain circumstances, the Traffic Manager also needs to know the MIME type of a response. For example, the Traffic Manager will only attempt to compress certain types of HTTP response data; if the MIME type is missing or incorrectly identified, the Traffic Manager's content compression will not operate correctly.

In this situation, click **Virtual Servers > Edit > Protocol Settings > HTTP Specific Settings** and enable **mime!detect** to engage MIME Type auto-detection. The Traffic Manager applies a range of heuristics to deduce the MIME type of the response data; auto-detection takes place when all of the following are true:

- There is a response body.
- The Content-Type header is missing, or it matches the value of **mime!default**.
- The response is not compressed.

The Traffic Manager will de-chunk data if necessary, if chunk-transfer encoding was used.

You should only configure MIME Type auto-detection when absolutely necessary, as it will reduce the performance of the Traffic Manager system.

Location Header Settings

This setting provides rewriting for the most usual URL redirection responses coming from a webserver, that is, 301 (object moved permanently) and 302 (object moved temporarily).

- **location!regex:** enter a regular expression to match the expected response from the node (a 301/302 redirection). You can use generic characters like `(.*)` to match parts of the expression.
- **location!replace:** enter a regular expression using `$1` to `$9` to redirect the response to a different object.
- **location!rewrite:** select the desired response in case the response from the node does not match the expression provided in **location!regex**.



Before using regular expressions, read and understand the security considerations in [Using Regular Expressions](#).

For example, using the following values:

- `location!regex= (.*)www.example.com/products/(.*)`
- `location!replace= $1products.example.com/$2`

If the webserver returns a response such as the following:

```
HTTP/1.1 302 Moved Temporarily
Location: http://www.example.com/products/hacksaw.htm
```

The Traffic Manager rewrites it to:

```
HTTP/1.1 302 Moved Temporarily
Location: http://products.example.com/hacksaw.htm
```

Handling Errors

Click **Virtual Servers > Edit > Error Logging** to enable logging of connection errors encountered by your virtual server.

Connection errors may occur for a variety of reasons:

- All of the nodes in the selected pool are unavailable.

- The connection with the back-end server timed out and could not be retried (see [Retrying Failed Requests](#)).
- An SSL protocol error occurred in the server-side or client-side connection.
- The back-end server did not return a valid response (for example, a mal-formed HTTP response).

Client connection errors are likely to be due to the actions or behavior of clients, and are mostly not under the control of the Traffic Manager. Server connection errors relate to the Traffic Manager to back-end server connection and so are likely to be affected by, and ultimately can be corrected by, the Traffic Manager and your back-end server configurations.

Generally, connection errors are not logged, unless they relate to errors with the back-end servers that are detected by passive monitoring.

For debugging purposes, it can be very useful to log these errors:

- **log!client_connection_failures**: this setting enables verbose logging of client-connection errors to the error log, or another location if specified by the Event Handling settings in your Traffic Manager.
- **log!server_connection_errors**: this setting enables verbose logging of server connection errors, and any internal faults in the Traffic Manager (such as a TrafficScript rule abort because the **max_instr** limit is exceeded).
- **log!ssl_failures**: this setting enables logging of failures that occur during SSL negotiation with clients and servers.

For more information, see [Troubleshooting](#).

Returning a Custom Error Message

If the Traffic Manager is unable to obtain a valid response for a request, and the client connection is still alive, it will close the client connection or (for HTTP only) return the following error to the client:

```
Service Unavailable
The service is temporarily unavailable. Please try again later.
```

This error message can be replaced, using the contents of a file uploaded to the “conf/extra” resource folder. To select an error file, use the **error_file** setting on the **Virtual Servers > Edit > Protocol Settings > Error Handling** page.

Files can be uploaded to the “conf/extra” resource folder using the **Catalog > Extra Files > Miscellaneous Files** configuration page.

The Traffic Manager is capable of processing HTTP headers within your error file, regardless of the actual file type, when you wish to set explicit directions on how the file should be handled. For example, you could set the “Content-Type” header if you wish to display a file of a particular type, such as a GIF or JPG image file. In this case, you would append the following lines to the top of your binary file:

```
Content-Type: image/gif
```

This capability can be extended to override the HTTP response code, as per the following example:

```
HTTP/1.1 200 OK
```

This would force the Traffic Manager to return the desired code in its response to the client.



It is important to remember to include a blank line after any headers, before the actual content of the file.

Memory Limits for Connections

The Traffic Manager allows configurable limits on the amount of memory your virtual server can use for each connection:

- **max_client_buffer:** The limit on the amount of data the Traffic Manager receives from the client (to send to the server) that is buffered. The Traffic Manager responds differently when the limit is reached, depending on the state of the connection:
 - If the Traffic Manager is still reading in HTTP headers, it sends a 413 HTTP error code to the client and logs a warning.
 - If the Traffic Manager is still running request rules, it continues buffering and logs a warning.
 - If the Traffic Manager has reached the stage of streaming data to the server (request rule processing has finished), it applies flow control. In this scenario the client-side of the connection is paused, so the Traffic Manager does not read in any more data from the client until it has managed to push some of the buffered data to the server.
- **max_server_buffer:** The limit on the amount of data the Traffic Manager receives from the server (to send to the client) that is buffered. The Traffic Manager responds differently when the limit is reached, depending on the state of the connection:

- If the Traffic Manager is still reading in response headers, it sends a 500 HTTP error code to the client and logs a warning.
- If the Traffic Manager is still running response rules, it continues buffering and logs a warning.
- If the Traffic Manager has commenced streaming the response to the client (response rule processing has completed), it applies flow control. In this scenario the server-side of the connection is paused, so the Traffic Manager does not read in any more data from the server until it has managed to push some of the buffered data to the client.



It is possible for both limits to become active at the same time. If the Traffic Manager has reached the stage of streaming the request body to the server and the server starts to stream its response body before it has read the complete request body, and if both client and server are quick to send but slow to read, the Traffic Manager might activate both flow control mechanisms simultaneously.

Pools

This chapter describes the concept of a pool, a configuration object used to represent a logical group of back-end nodes.

Introduction

A virtual server assigns requests to a pool, which then load-balances these requests across a number of defined server nodes. Each node in the pool must be able to receive requests through the port specified, using the virtual server's protocol.

As well as load balancing, each pool has its own settings for session persistence, SSL encryption of traffic, and health monitoring.

To access the pool configuration pages, click **Services > Pools**. Use this page to modify the settings for an existing pool, or to add a new pool.

When you create a pool, you select one of the following categories:

- **Static:** The list of nodes is declared and managed by the administrator through the Admin UI or one of the Traffic Manager APIs. This pool's node list does not change unless modified by the administrator.
- **Dynamic:** The list of nodes is generated and managed automatically through the use of autoscaling or a plug-in Service Discovery script. To learn more about autoscaling, see [Autoscaling](#) or [DNS-Derived Autoscaling](#). To learn more about Service Discovery plug-ins, see [Service Discovery](#).

Each node is identified as a combination of a server name or IP address, and port. Examples of valid node entries are:

- server1.mysite.com:80
- 192.0.2.1:1234
- [2001:DB8:1b6c:6402:250:56ff:fea6:3f43]:4444

To specify a node as an IPv6 address, use the URI bracket notation format [`<IPv6 address>`]:`<port>`.



The Traffic Manager does not support the use of IPv6 link local addresses for nodes.

Load Balancing

The Traffic Manager offers a choice of load-balancing algorithms that distribute requests among the nodes in the pool. The algorithms are as follows:

| Algorithm | Description |
|----------------------------|--|
| Round Robin | Connections are routed to each of the back-end servers in turn. |
| Weighted Round Robin | As for Round Robin, but with different proportions of traffic directed to each node. The weighting for each node must be specified using the entry boxes provided. |
| Perceptive | Monitors the load and response times of each node, and predicts the best distribution of traffic. This optimizes response times and ensures that no one server is overloaded. |
| Least Connections | Chooses the back-end server which currently has the smallest number of connections. |
| Weighted Least Connections | Chooses the back-end server which currently has the smallest number of connections, scaled by the weight of each server. Weights can be specified in the entry boxes provided. |
| Fastest Response Time | Sends traffic to the back-end server currently giving the fastest response time. |
| Random Node | Chooses a back-end server at random. |



(Traffic Manager multi-site mode only) Node weightings cannot be switched between single and multiple location-based input like other areas of the Traffic Manager UI. Instead, if you have chosen to configure your nodes by location, the associated weightings will automatically be displayed by the locations used.

Selecting the Optimum Load Balancing Method

“Least Connections” is generally the best load balancing algorithm for homogeneous traffic, where every request puts the same load on the back-end server and where every back-end server is the same performance. The majority of HTTP services fall into this situation. Even if some requests generate more load than others (for example, a database lookup compared to an image retrieval), the Least Connections method will evenly distribute requests across the machines and if there are sufficient requests of each type, the load will be very effectively shared. Weighted Least Connections is a refinement which can be used when the servers have different capacities; servers with larger weights will receive more connections in proportion to their weights.

Least Connections is not appropriate when individual high-load requests cause significant slowdowns, and these requests are infrequent. Neither is it appropriate when the different servers have different capacities. The “Fastest Response Time” algorithm will send requests to the server that is performing best (responding most quickly), but it is a reactive algorithm (it only notices slowdowns after the event) so it can often overload a fast server and create a choppy performance profile.

“Perceptive” is designed to take the best features of both Least Connections and Fastest Response Time. It adapts according to the nature of the traffic and the performance of the servers; it will lean towards Least Connections when traffic is homogeneous, and Fastest Response Time when the loads are very variable. It uses a combination of the number of current connections and recent response times to trend and predict the performance of each server.

Under this algorithm, traffic is introduced to a new server (or a server that has returned from a failed state) gently, and is progressively ramped up to full operation. When a new server is added to a pool, the algorithm tries it with a single request, and if it receives a reply, gradually increases the number of requests it sends the new server until it is receiving the same proportion of the load as other equivalent nodes in the pool. This ramping is done in an adaptive way, dependent on the responsiveness of the server. So, for example, a new Web server serving a small quantity of static content will very quickly be ramped up to full speed, whereas a Java application server that compiles JSPs the first time they are used (and so is slow to respond to begin with) will be ramped up more slowly.

Least Connections is simpler and more deterministic than Perceptive, so should be used in preference when appropriate.

Caveats with Load Balancing Algorithms

Least Connections, Fastest Response Time and Perceptive can all have unexpected behavior at very low traffic levels. Least Connections will not distribute requests if you only ever subject it to one connection at a time; Perceptive and Fastest Response Time will tend to favor nodes with known good response times and will ignore nodes that are untested.

Load balancing metrics are not shared between Traffic Managers in a cluster. For example, if two Traffic Managers use the Round Robin algorithm to distribute requests, they will each progress through the nodes in turn, but independently.

Most load balancing metrics are shared between processes (CPU cores) when the traffic management software runs on a multi-core server. The one exception is response time information; this is not shared across cores.

If you are testing your back-end servers and want to be sure that traffic is directed to all of them (and want request distribution rather than load balancing), then use "Round Robin" or "Random" for your test traffic.

Locality Aware Request Distribution (LARD)

Perceptive, Least Connections and Fastest Response Time all use a technique called LARD (Locality Aware Request Distribution) to try and send the same request to the same back-end server. This technique takes advantage of server caching; if a server returns a particular item of content, it is likely that it will be able to serve the same content quickly again because the content will be located in an internal cache (memory or disk).

When each algorithm makes its load balancing decision, it weights the decision with information as to which node processed the same request previously:

- Least Connections will choose the favored node if there are several candidates for the node with least connections, and the favored node is one of them.
- Perceptive and Response Time algorithms give a light additional weight to the favored node in their internal selection.

Locality Aware Request Distribution is a lightweight way to advise the Traffic Manager how to route requests to back-end nodes. If you wish to mandate that requests for the same URL are sent to the same back-end server, you should use Universal Session Persistence (keyed by the URL) ([Session Persistence](#)) to do this more forcefully. Alternatively, you can gain full control over request routing using TrafficScript and named node persistence, forward proxy or pool selection techniques.

Session Persistence

Session persistence is the process by which all requests from the same client session are sent to the same back-end server. It can be used for any TCP or UDP protocol.

A pool serving static Web content usually has no requirement for session persistence; each page or image for a particular client can be served from a different machine with no ill effects. Another pool, serving an online shopping site, may use session persistence to ensure that a user's requests are always directed to the node holding details about their shopping basket.

The Traffic Manager offers several methods to identify requests which belong to the same session. A variety of different cookies can be used; persistence can be based on a rule; or the client's IP address can be used to identify sessions. If incoming traffic is SSL-encrypted, the SSL session ID can be used.

You can choose what to do if a persistent session is lost. This might be due to invalid session data, or because the node handling it has failed. In this case you can choose to close the connection, have requests sent to a new node, or redirect the user to a specified URL such as an error page.

You can apply session persistence to a pool by clicking the **Session Persistence** link on the **Pools > Edit** page for that pool. Select a session persistence class and click the **Update** button.

Care must be taken when using a persistence class that is already in use by another pool. You should only re-use a persistence class if the nodes in this pool match those in the pool already using the class. Session affinity cannot be guaranteed where a persistence class is in use by two or more pools with different nodes.

Session Persistence is described in more detail in [Session Persistence](#).

Bandwidth Management

The Traffic Manager can apply limits on the bandwidth used by connections to the back-end nodes. These limits may be useful if the back-end nodes reside in a remote datacenter, and the bandwidth to the remote site needs to be managed.

You can apply bandwidth limits to a pool by clicking the **Bandwidth Management** link on the **Pools > Edit** page for that pool. Select a bandwidth management class and click the **Update** button.



The bandwidth limit only applies to data sent from the Traffic Manager system to the remote server node. The Traffic Manager does not apply a limit on the bandwidth from the remote node back to the Traffic Manager. Bandwidth Management is covered in detail in [Bandwidth Management](#).



Bandwidth Management is not available on all Traffic Manager configurations. If required, it can be obtained via a software or license key upgrade.

Health Monitoring

If the Traffic Manager sends a request to a node and receives no response, it assumes that node has failed. It stops sending it requests and balances traffic across the remainder of the pool.

The Traffic Manager's "Health Monitors" can run sophisticated health checks against back-end server nodes to determine whether they are operating correctly.

When a health monitor is assigned to a pool, it periodically checks each node in the pool; if it detects a certain number of failures, the Traffic Manager assumes that the node or pool is unavailable. These health tests are performed in addition to the Traffic Manager's connection tests when it attempts to send requests to and read responses from nodes.

The health monitors provide a range of tests, from simple tests, such as pinging each node, to more sophisticated tests that check that the appropriate port is open and the node is able to serve specified data, such as your home page. A number of pre-configured monitors are available to perform specific tasks (such as verify a POP3 login), and it is possible to create custom monitors to perform any test that is required.

Monitors fall into two categories: per-node and pool-wide. A per-node monitor tests the health of each node in the pool. A pool-wide monitor performs tests on one machine which influences the health of the entire pool. For example, a mail server pool might keep its data on an NFS server, which each of your back-end servers accesses. A pool-wide monitor could test this server. If it fails, none of the back ends can retrieve the data so the whole pool is deemed to have failed.

On the **Pools > Edit** page, click the **Health Monitors** link to assign health monitors to a pool. When you have chosen your settings, click **Update** to apply them.

Health Monitors are described in more detail in [Health Monitoring](#).

SSL Encryption

You may wish to encrypt data before sending it from the Traffic Manager to the back ends.

On the **Pools > Edit** page, click the **SSL Settings** link to specify SSL encryption settings. When you have chosen your settings, click **Update** to apply them.

SSL configuration is covered in detail in [SSL Encryption](#).

Protocol Settings

Click **Pools > Edit > Protocol Settings** to configure settings for managing connections between the Traffic Manager and back-end nodes. These settings include:

- Whether to force a connection from the Traffic Manager to the nodes to originate from a particular IP address.
- Whether to maintain HTTP keepalive connections to the nodes.
- The maximum number of times to establish a connection or wait for a response from a node.
- The maximum number of nodes to try before giving up and returning an error to the client.
- Whether to close connections from the Traffic Manager to the nodes with a RST packet rather than the default FIN packet. See [Protocol Settings](#) for further information on the effect of this setting.

You do not normally need to change any of these settings. The default values have been chosen to give good performance on a wide range of systems.

Limiting Requests to a Pool

Introduction

All servers or applications use certain amounts of system resources to process a request. These resources can include threads, file descriptors, and an amount of memory. Each back-end server might be able to process a certain number of concurrent connections before system performance is affected. Furthermore, the request/response transactions performed within a connection can also negatively affect performance through handling too many resource-intensive tasks simultaneously. In extreme cases, the server can be seen to queue, drop, or refuse new connections while the overloaded system attempts to keep up with demand.

In cases such as these, placing hard limits on the number of concurrent connections that a server node receives, or on the number of transactions a node can process concurrently, can keep your pool nodes running at an optimal level while guaranteeing that they do not get overloaded.

Connection and transaction limiting can impact other Traffic Manager features. To understand the effect of using limits, read this section fully prior to implementation.

Applying Limits

The Traffic Manager allows the imposition of limits on the number of concurrent connections or transactions a pool node can process simultaneously. Connection-based limiting is useful for protecting back-end server nodes running applications that consume resources on a per-connection basis. The Traffic Manager can also be configured with transaction limiting to queue up incoming HTTP requests if all the nodes in the chosen pool are already busy handling previous transactions.

Connection and transaction limiting are both configured at a pool level and are applied to each node within that pool. If, for example, you set a connection limit of 50, each node in the pool receives a maximum of 50 concurrent connections. Use of the limits assumes that all of the nodes within a pool are of the same specification and are providing the same application. If the same node is present in multiple pools, the potential concurrent connections to that node, or transactions handled by the node, are the sum of the rate limits configured for each corresponding pool.



Connection limiting applies only to TCP connections. Transaction limiting applies only to services using the HTTP protocol.

Connection Limiting Within a Traffic Manager Cluster

Connections to back-end server nodes are not shared amongst Traffic Managers in a cluster. In an active-passive Traffic Manager pair, all connections are used by the active Traffic Manager and none by the passive Traffic Manager. In an active-active scenario, the connection limits effectively double. For an active-active-active Traffic Manager cluster, connection limits triple, and so on.

Queuing Requests

When a node is chosen by a load balancing algorithm, the Traffic Manager checks to determine if the number of concurrent connections has yet reached the defined limit, if one is set. Equally, the Traffic Manager checks if the number of transactions being processed by the node has reached the defined transaction limit. If either case is true, the Traffic Manager begins storing subsequent requests in a queue.

When demand continually exceeds the permitted limits for a long enough period of time, there is a risk (in the case of HTTP, for example) that the response to the client can time out. In order to help mitigate this risk, the TrafficScript function `connection.checkLimits()` can be used to detect when a pool has started queuing requests. The Traffic Manager can use this information, for example, to respond immediately to the client with a different page rather than letting the response time out. For more details, see the *Pulse Secure Virtual Traffic Manager: TrafficScript Guide*.

Considerations for Other Traffic Manager Features

Request limiting is a powerful capability, and can interact with several other features of the Traffic Manager. This section describes those interactions so that you can plan your implementation accordingly.

Queue Management and SIP

RFC 3261 - SIP: Session Initiation Protocol, section 17.2.1, defines specific behavior in regards to what must happen when the response time of a SIP server is going to take longer than 100ms. The Traffic Manager has been developed to adhere to this part of the SIP specification.

“The server transaction MUST generate a 100 (Trying) response unless it knows that the TU will generate a provisional or final response within 200 ms, in which case it MAY generate a 100 (Trying) response.”
[\[http://www.faqs.org/rfcs/rfc3261.html\]](http://www.faqs.org/rfcs/rfc3261.html)

Request Rate Shaping

The Traffic Manager's request rate shaping feature uses a queue mechanism that is different from the one used by the transaction and connection limiting features. Because a limit breach might cause the Traffic Manager to queue a request after being dequeued from a rate shaping class, it is possible that the rate of requests getting sent to a node might vary from what was specified by the rate shaping class.

Service Level Monitoring

The response time measured by a Service Level Monitoring (SLM) class is affected when requests sent to a node are queued due to the transaction or connection limit being breached; for SLM purposes, time spent in the request queue is counted as part of the response time.

Setting Pool Request Limits

To configure the limit for the maximum number of connections or transactions processed by a node before queuing starts, use the following steps:

1. Click **Services > Pools > Edit > Protocol Settings**.
2. For a connection limit, set **max_connections_pernode** to the desired number. For a transaction limit, set **max_transactions_per_node**.
3. Scroll to the bottom of the page and click **Update**.

Limit Options

You can configure the following additional options that apply to the request queue:

| Configuration Option | Description |
|----------------------|---|
| queue_timeout | The number of seconds after which queued requests are discarded. |
| max_queue_size | The number of requests that can remain queued while waiting for a node to become available. A value of 0 denotes an unlimited queue size. |

Tracking Limits

Because connection and transaction limiting involves queuing, requests can time out. Use the Current Activity graph to track the number of requests queued and the number of request that time out while queued:

1. Navigate to **Activity > Current Activity**.
2. Click the Change data button.
3. Un-tick any boxes that are currently ticked.
4. Expand the Pools branch of the Values tree.
5. Tick the boxes that correspond to **ConnsQueued** and **QueueTimeouts**.
6. If you want to also check that request limiting is working, expand the Nodes branch of the Values tree.
7. Tick the **CurrentConn** box.
8. Scroll to the bottom of the page.
9. In the **New Settings** field, enter a name for your new chart (for example, Request Limits).
10. Click the radio button next to **New Settings**.
11. Click **Apply**.

Testing Configured Limits

The "zeusbench" utility can be used to check whether or not the limits you have configured are working properly. The zeusbench utility can be found in \$ZEUSHOME/admin/bin. Running zeusbench in concurrency mode should be able to generate enough traffic to exhaust the free connections to your back-end nodes. If (for example) you have a pool of 2 nodes and you have configured a limit of 10 connections per node, the following zeusbench command should cause connections to be queued:

```
./zeusbench -c 100 -t 60 http://<your site>/index.html
```

zeusbench will attempt to open 100 connections to the virtual server you specify (by URL) and send as many requests down each one as fast as possible. This should result in a similar number of active connections being made to the pool under test. Keep in mind that the more nodes you have, the more concurrent connections you will need to specify when invoking the zeusbench utility.

Back-End Fault Tolerance

The Traffic Manager has a strong approach to fault tolerance. Pools can be configured in a number of ways to ensure that traffic is managed as efficiently as possible.

If a node in a pool fails, this is detected by the Traffic Manager's health monitors. It can also be detected during load balancing, if the node does not respond to a request. No more requests are sent to that node, but are instead distributed across the other nodes in the pool. When the failed node recovers, it is brought back into service slowly until the Traffic Manager is satisfied that it can be relied upon.

A pool can be associated with a "failure pool". If every node in the original pool should fail, requests will be diverted to this failure pool.

To set a failure pool, click **Services > Pools** and then click the name of the pool you want to modify. In the "Basic Settings" section, select a failure pool from the drop-down list.

A typical failure pool for an HTTP service might consist of a single "sorry server". This can rewrite all requests it receives to request a simple Web page, which displays an "out of service" message.



The Traffic Manager provides a direct way to serve a simple error page if a pool fails. For instructions on how to set up a custom error page, see [Handling Errors](#).

Priority Lists

Within a pool, you can set up a priority list. This allows you to group the nodes in order of priority. You can specify the minimum number of machines you want to receive traffic at any one time.

Suppose you have three servers, "primary1", "primary2" and "primary3", used for normal traffic, and two off-site backup servers, "backup1" and "backup2". Your requirement might be to ensure at least two servers are always available.

The two backup servers could be set up as a failure pool for the three primary servers: however, the failure pool is only used if every node in the primary pool fails. If both primary1 and primary3 were to fail, only primary2 would receive traffic.

Instead, you can set up a grouped priority list. This has two priority groups: {primary1, primary2, primary3} and, below it, {backup1, backup2}. You specify that a minimum of two nodes must be available at any one time.

With all the servers running, all three primary servers are in use; the backup machines do not receive traffic.

If primary1 fails, there are still two nodes in the higher group available to take requests; these two nodes handle all the traffic.

If primary3 now fails, only one node is left in the higher group. You have specified that two servers must be available. The Traffic Manager starts to send requests to both machines in the backup group: requests are now being handled by primary2, backup1 and backup2.

No more priority levels are available. In the event that more nodes fail, traffic is balanced across the remaining nodes. If every node fails traffic will be passed to the pool's failure pool, if it has one.

▼ Priority Lists

Priority Lists control the order of preference in which the nodes in a pool are used.

To alter the priorities of the nodes use the up and down buttons.

Enable priority lists

priority!enabled: Yes No

Minimum number of highest-priority active nodes

priority!nodes:

Highest Priority Group

| Node | Up | Down |
|-------------|----|------|
| primary1:80 | ▲ | ▼ |
| primary2:80 | ▲ | ▼ |
| primary3:80 | ▲ | ▼ |

Lowest Priority Group

| Node | Up | Down |
|------------|----|------|
| backup1:80 | ▲ | ▼ |
| backup2:80 | ▲ | ▼ |

To set up priority groups for a pool, edit that pool via the **Pools > Edit** page. Click **Load Balancing**, and unfold the “Priority Lists” section.

The nodes in the pool are shown in a list, marked **Highest Priority Group**. To enable priority lists for this pool, set **priority!enabled** to “Yes” and **priority!nodes** to the minimum number of nodes you want to be continuously available. Then use the up and down arrows beside each node to create other groups above or below the original one.



The nodes in the lower priority groups are not used, until the number of nodes available in the highest group falls below the minimum you specified. Then all the nodes in the next group down are brought into service. The healthy servers from these top two groups are used, until enough of them fail that fewer than your specified minimum are available; at this point the whole of the next group is brought into use. This continues until all the priority groups are being used.

If every node in the pool should fail, requests will be directed to its failure pool, if one is configured.

Draining, Disabling, or Removing a Node

You might occasionally want to remove one of your back-end nodes from your load-balanced server farm. This could be permanent, or a temporary measure to allow for maintenance or upgrade.

Choose to either "disable" or "drain" the node, such that the Traffic Manager does not send any new requests, or just remove the node completely from the pool:

- **Disable a node:** Stops the Traffic Manager sending any more connections to the node. The node remains present in the pool configuration, although the Traffic Manager ceases monitoring it. For more details, see [Disabling a Node](#).
- **Drain a node:** Stops the Traffic Manager sending any more new connections to the node, but honors established sessions. The Traffic Manager continues to actively monitor the node. For more details, see [Draining a Node](#).
- **Remove a node:** Permanently removes the node from the pool configuration. For more details, see [Removing Nodes From a Pool](#).

To disable, drain, or remove a node from a pool, use the **Services > Pools > Edit** page. Edit a pool containing the node and change the node status to "Disabled" or "Draining" as required. To remove the node, tick the adjacent **Delete** checkbox. To save your changes, click **Update**.



This process only drains, disables, or removes the node for that particular pool. Any other pools using the same node are unaffected.

Using the Node Wizards

To simplify the processes of disabling, draining, reactivating, or removing nodes across a range of your services, the Traffic Manager provides a series of wizards. To access the wizards, use the *Wizards* menu in the top tool bar:

- Disable a node
- Drain a node
- Reactivate a node
- Remove a node

You specify a node to drain/disable (depending on the wizard chosen), and choose whether to apply this for all services or just those you specify. You can restore the node to active status later using the *Reactivate a node* wizard. To remove a node completely from one or all of your services, use the *Remove a node* wizard.

Disabling a Node

Consider disabling a node if you plan to take it out of service temporarily. Existing connections to the node are handled according to the settings discussed in [Altering the Behavior of Existing Connections when Disabling or Removing a Node](#). If the node stops working (for example, because you shut down the server), the Traffic Manager does not report an error. The advantage of disabling a node rather than removing it from the configuration is that a disabled node can easily be re-instated when it is ready to be used.

Draining a Node

Consider draining a node if you are concerned about existing sessions, but bear in mind that if the node stops working, the Traffic Manager reports an error. If the Traffic Manager receives a request and session persistence requires that the node is used, the Traffic Manager continues to use it. If you plan to shut the node down, you should drain it first, waiting until all sessions have completed, then disable it.

To find out whether the node is still handling connections, click **Activity > Draining Nodes**. This page shows the number of connections the node is still handling, and the time since the last connection. For more details, see [Draining Connections](#). When the node's existing connections have expired, you can disable it, or use the *Remove a Node* wizard to remove it cleanly from your cluster.

Removing Nodes From a Pool

If you plan to retire one or more server nodes from the pool permanently, and have no requirement to retain any corresponding configuration, delete the nodes from the pool. Existing connections to the node are handled according to the settings discussed in [Altering the Behavior of Existing Connections when Disabling or Removing a Node](#).

If you attempt to remove all nodes from the pool, the Admin UI issues a warning that no new traffic can be received by the pool, and requires explicit consent before this action is completed. To override the warning, tick the confirmation checkbox adjacent to the **Update** button and try again.

Altering the Behavior of Existing Connections when Disabling or Removing a Node

The behavior of existing connections to nodes that you either *disable* or *remove* is dependent on the value of **node_delete_behavior** (found in **Services > Pools > Edit > Protocol Settings**). This setting has two options:

- **All connections to the node are closed immediately:** the Traffic Manager terminates all connections to the node immediately.
- **Allow existing connections to the node to finish before deletion:** any node that is disabled or removed while it has existing connections is kept in a "Draining"-like state, until it is automatically disabled or removed at the earliest occurrence of one of the following events:
 - its connection count dropping to zero
 - the value of **node_drain_to_delete_timeout** (found in **Services > Pools > Edit > Protocol Settings**) being reached (if non-zero).

Such draining nodes are included in the list at **Activity > Draining Nodes**, with "Yes" in the "Autodelete" column.

Autoscaling



Autoscaling is a license key controlled feature and is not available on all Traffic Manager variants. See the Ivanti Web site for details about supported configurations.

Introduction

The "application autoscaling" option monitors the performance of a service running on a supported virtual or cloud platform. When the performance falls outside the desired service level, the Traffic Manager can then initiate an autoscaling action, requesting that the platform deploys additional instances of the service. The Traffic Manager will automatically load balance traffic to the new instances as soon as they are available. The Autoscaling feature consists of a monitoring and decision engine, and a collection of driver scripts that interface with the relevant platform.

Autoscaling is a property of a pool. If enabled, you do not need to provide a specific list of nodes in the pool configuration. Instead, if performance starts to degrade, additional nodes can be requisitioned automatically to provide the extra capacity required. Conversely, a pool can be scaled back to free up additional nodes when they are not required. Hence this feature can be used to dynamically react to both short bursts of traffic or long-term increases in load.

A built-in service monitor is used to determine when a pool needs to be auto-scaled up or down. The service level (response time) delivered by a pool is monitored closely. If the response time falls outside the desired level, then Autoscaling will add or remove nodes from the pool to increase or reduce resource in order to meet the service level at the lowest cost.

How It Works

The autoscaling mechanism consists of a Decision Engine and a collection of platform-dependent Driver scripts.

The Decision Engine

This monitors the response time from the pool, and provides scale-up/scale-down thresholds. Other parameters control the minimum and maximum number of nodes in a pool, and the length of time the Traffic Manager will wait for the response time to stabilize once a scale-up or scale-down is completed.

For example, you may wish to maintain an SLA of 250ms. You can instruct the Traffic Manager to scale up (add nodes) if less than 50% of transactions are completed within this SLA, up to a maximum of 10 back-end nodes. Alternatively, it should scale-down (remove nodes) progressively to a minimum of 1 node if more than 95% of transactions are completed.



You can manually provision nodes by editing the max-nodes and min-nodes settings in the pool. If the Traffic Manager notices that there is a mismatch between the max/min and the actual number of nodes active, then it will initiate a series of scale-up or scale-down actions.

The Cloud API Driver

The Traffic Manager includes API driver scripts for Amazon EC2, Rackspace and VMware vSphere cloud environments. Before you can create an autoscaling pool, you must first create a set of cloud credentials pertaining to the cloud API you wish to use. These credentials contain the information required to allow a Traffic Manager to communicate with the aforementioned cloud providers. The precise credentials used will depend on the cloud provider that you specify. For details, see [Cloud Credentials](#).

The decision engine initiates a scale-up or scale-down action by invoking the driver with the configured credentials and parameters. The driver instructs the virtualization layer to deploy or terminate a virtual machine. Once the action is complete, the driver returns the new list of nodes in the pool and the decision engine updates the pool configuration.

Example Timeline for an Autoscaling Event

The following diagram depicts the timeline of an autoscaling event in the Traffic Manager. At the point the "scale-up threshold" is breached, the hysteresis period begins to ensure that the condition persists and is not just a momentary spike. Should the performance of the pool return to the expected level during this period, the Traffic Manager then abandons the autoscaling event.

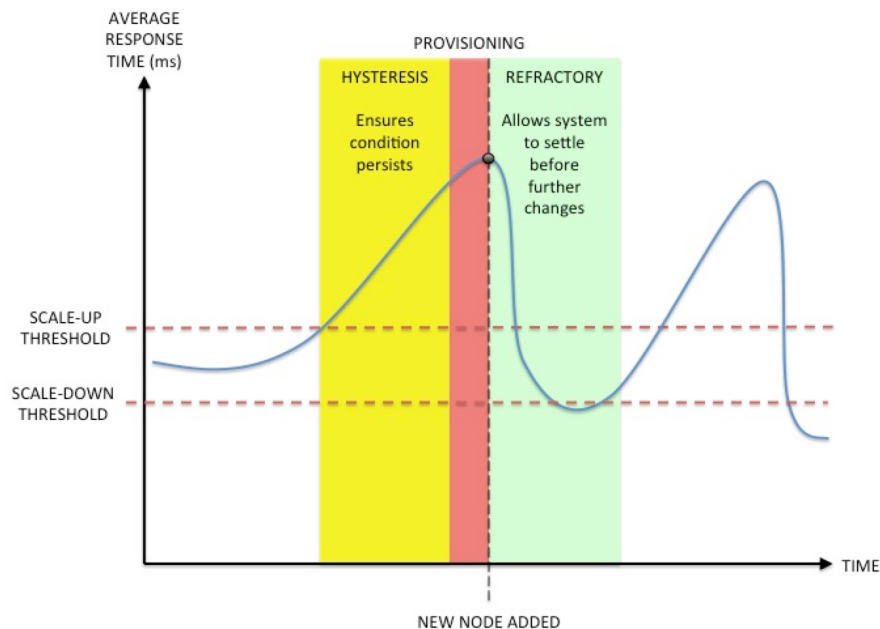

After the threshold breach has persisted for the length of the hysteresis period, the Traffic Manager's autoscaling mechanism triggers the creation (or deletion, if the diagram were to depict a scale-down event) of a new backend server node instance using the API of the chosen cloud or hypervisor. This process culminates in the successful creation of the node and its addition to the load-balancing pool.

With the addition of the new server node to the pool, the refractory period begins. During this period, the Traffic Manager ensures no further autoscaling events are triggered, and thus ensures that the performance of the service is able to settle to its new level before being re-assessed against the scaling thresholds.

To configure the thresholds and periods described here, see [Configuring Autoscaling](#).

Configuring Autoscaling

The mechanism employed to implement autoscaling in a pool involves allowing the Traffic Manager to automatically make modifications to the pool configuration file (for example, to add or remove nodes as they are required). Where such a pool is in active use, there is a small possibility that this process of automatic updates could interfere with configuration changes made by the user through the Admin UI or Traffic Manager APIs, if they occur simultaneously. Therefore, Ivanti recommends that users double-check that their updates have taken effect by refreshing the pool page after making a change.

After you have created a set of credentials for your chosen cloud API, you can proceed to configure the autoscaling properties of your selected pool. For a new pool, use a pool type of **Dynamic...** and then select **Ivanti vTM Autoscaler** from the list of available options. For an existing pool, click **Pools > Edit > Autoscaling** to display the available configuration options:

Basic Settings

| Setting | Description |
|--------------------|--|
| autoscale!enabled | Enables or disables Autoscaling. When this is enabled, nodes will be added and removed from the pool using the mechanism specified by autoscale!external . |
| autoscale!external | Some cloud providers have their own mechanism for performing autoscaling. In this case, a cloud provider would monitor the performance for a group of machines (those being the machines in the pool) and will add and remove machines as needed. The cloud provider will indicate to the Traffic Manager that it has added or removed a machine using its API. When the Traffic Manager has been informed of the change, it will add or remove nodes from the autoscaling pool accordingly. If you intend to use your cloud provider's autoscaling mechanism, set this parameter to "Yes". If you intend to use the Traffic Manager's Autoscaling mechanism, set this to "No". |
| Cloud Credentials | The set of credential required by a cloud's API. You can pre-configure sets of cloud credentials on the Catalogs > Cloud Credentials page. |

The Traffic Manager uses the API type of the credentials you specify here to present a set of configuration keys applicable to the requirements of the cloud provider:

Amazon EC2 Cloud Settings

| Setting | Description |
|------------------------|---|
| EC2 AMI | <p>The unique identifier of the virtual machine image from which you create new node instances. The Traffic Manager adds each newly created node to the pool when it identifies the need to increase capacity. A Traffic Manager seeing instances in the cloud using this AMI assumes that those instances belong to the corresponding pool.</p> <p>The unique identifier used here determines the operating system and the services running on the node. In an EC2 cloud, this parameter is called <code>ImageId</code>.</p> |
| EC2 Machine Type | <p>The identifier that indicates the size--in terms of resources--of the virtual machine required for an instance of a node that is to be added to a pool. In EC2, this parameter is called <code>InstanceType</code>.</p> <p>Typically, more powerful machines are associated with higher costs.</p> |
| Name Prefix | <p>An optional prefix added to the name of new nodes created during an autoscaling event.</p> <p>A Traffic Manager seeing instances in the cloud starting with this name assumes those instances belong to the corresponding pool.</p> |
| EC2 Security Group IDs | <p>A security group acts as a firewall that controls the traffic for one or more node instances. When an instance is launched, EC2 can associate it with one or more security groups. To create this association, specify a list of security group IDs (do not use group names) in the Extra Arguments text box. For EC2-Classical deployments, you must use security groups created specifically for EC2-Classical. Similarly, for EC2-VPC, you must use security groups created specifically for your VPC. If you do not specify security groups here, EC2 applies the default security group.</p> |

| Setting | Description |
|------------------------------|---|
| EC2-VPC Subnet IDs | <p>A list of IDs of the VPC subnets where the new EC2-VPC instances are launched. Instances are evenly distributed among the subnets you specify in the Extra Arguments text box. To launch instances inside EC2-Classic, leave the list empty.</p> <p>To distribute auto-scaled EC2-VPC nodes evenly across different availability zones, Ivanti recommends listing the subnets present in different availability zones.</p> |
| Extra RunInstances Arguments | <p>A comma-separated list of key-value arguments for the AWS API function RunInstances, used at node creation time.</p> <p>Refer to the AWS documentation for RunInstances to see the list of available arguments.</p> |

Rackspace Cloud Settings

| Setting | Description |
|----------|---|
| Image ID | <p>The unique internal identifier of the virtual machine image from which you create new node instances. The Traffic Manager adds each newly created node to the pool when it identifies the need to increase capacity. The unique identifier used here determines the operating system and the services running on the node. In a Rackspace cloud, this parameter is called <code>imageid</code>.</p> <p>You must use the internal image identifier here.</p> <p>To get a list of the image identifiers available for a given set of cloud credentials, run the included <code>rackspace.pl</code> script manually from the command line:</p> <pre>\$ZEUSHOME/zxtm/bin/rackspace.pl \ listimageids \ --cloudcreds=<credentials></pre> <p>Replace <code><credentials></code> with your Rackspace cloud credentials.</p> |

| Setting | Description |
|-------------|---|
| Flavor ID | <p>The internal identifier that indicates the size--in terms of resources--of the virtual machine required for an instance of a node that is to be added to a pool. In Rackspace, this parameter is called FlavorId.</p> <p>Typically, more powerful machines are associated with higher costs.</p> <p>To get a list of the size identifiers available for a given set of cloud credentials, run the included <code>rackspace.pl</code> script manually from the command line:</p> <pre>\$ZEUSHOME/zxtm/bin/rackspace.pl \ listsizeids \ --cloudcreds=<credentials></pre> <p>Replace <code><credentials></code> with your Rackspace cloud credentials.</p> |
| Name Prefix | <p>The optional name prefix you can apply to each cloud-hosted virtual machine created by an autoscaling event. A Traffic Manager seeing instances in the cloud starting with this name assumes those instances belong to the corresponding pool.</p> |

VMware vSphere settings

| Setting | Description |
|-----------------|--|
| VMware Template | <p>The built-in vSphere driver script creates new Virtual Machines (VMs) by deploying them from existing VM templates. These templates are pre-configured VMs which are marked as a template upon which new VMs can be based. The path of the template on a vCenter server is usually in the form:</p> <pre><DatacenterName>/vm/<TemplateName></pre> |
| Name Prefix | <p>New nodes will be created with this name prefix on the vCenter Server. If multiple pools are autoscaling on the same vSphere infrastructure, care must be taken to keep the name prefixes for each pool unique.</p> |

| Setting | Description |
|--------------------|---|
| Data Center | All ESX hosts managed by the vCenter server are arranged in logical datacenters. Autoscaling is performed on the hosts or clusters contained within this datacenter. |
| Data Store | The data-store that will be used by the newly created virtual machines. If left blank, the default data-store used by the datacenter will be used (depending on the vCenter configuration). If a data-store is specified here, you should ensure the VM template uses the same data-store. |
| VMware ESX Cluster | The infrastructure on a vCenter server usually has a datacenter at the top level, which contains ESX hosts or a cluster of ESX hosts. If a cluster is configured with Dynamic Resource Scheduling (DRS), vCenter decides the hosts upon which new virtual machines will be placed. If no cluster is configured, this setting should contain the ESX hostname or IP where the new VMs are to be created. |

Node Settings

| Setting | Description |
|--------------------|---|
| autoscale!ipstouse | (IP addresses-to-use) Instances in cloud environments typically have at least two IP addresses: one on a private network for communication with other nodes in the same cloud, and one on a public network for communication with the Internet in general. Select "private" or "public" to define whether traffic should be sent to the new node's private address, or its public address. Instances inside Amazon EC2-VPC do not have a public IP address by default. Select "public" to assign one at creation time. |
| autoscale!port | This defines the port to use when adding nodes to the pool. This port corresponds to the service listening on the back-end machine that gets spawned in the cloud environment. |

| Setting | Description |
|---------------------|--|
| autoscale!min_nodes | This defines the minimum number of nodes that are allowed to exist in the autoscaling pool. Note that this number will also include nodes that are currently marked as failed. A node failure in these circumstances can lead to a degradation in response times, which in turn will result in a new node being auto-scaled in. This behavior is not guaranteed, however. An autoscaling pool that contains failed nodes will not auto-scale beyond the number specified by autoscale!max_nodes . |
| autoscale!max_nodes | This defines the maximum number of nodes that are allowed to exist in the autoscaling pool. This ensures that a pool cannot auto-scale to an enormous number by itself. |

Scaling parameters

| Setting | Description |
|---------------------------|---|
| autoscale!response_time | The Traffic Manager monitors the response times (in milliseconds) of the nodes in an autoscaling pool. This is measured from the time the Traffic Manager starts initiating a connection to the node until it receives the first byte of the response. A response time of less than autoscale!response_time is considered conforming and longer times are considered non-conforming. The Traffic Manager continuously measures the percentage of conforming connections. |
| autoscale!scaledown_level | When the percentage of conforming responses rises above this value for at least autoscale!hysteresis seconds, the pool is scaled down (in other words, a node is removed from the pool). |
| autoscale!scaleup_level | When the percentage of conforming responses falls below this value for at least autoscale!hysteresis seconds, the pool is scaled up (in other words, a node is added to the pool). |

| Setting | Description |
|-----------------------------|---|
| autoscale!refractory | After a change to the pool size has been made (be it an increase or a decrease), the Traffic Manager will wait autoscale!refractory seconds before making another change. It will take some time for the new node to have its effect on the overall response times of the pool. So to prevent too many nodes from being created (or destroyed) at a time, you may want to increase this time period. |
| autoscale!hysteresis | The amount of time (in seconds) that an autoscaling condition must exist before the Traffic Manager instigates a change. This corresponds to (for example) the time that the pool's percentage of conforming connections must remain below autoscale!scaleup_level before a scale-up event occurs. |
| autoscale!lastnode_idletime | The time (in seconds) for which the last node in an auto-scaled pool must have been idle before it is destroyed. This is only relevant if autoscale!min_nodes is set to 0. |

DNS-Derived Autoscaling



This feature is also available as a Service Discovery plug-in, with additional customization options. For more information, see [Service Discovery](#).

The Traffic Manager can use DNS records to automatically expand or shrink the number of nodes in a pool to meet the demands of the traffic it is handling. This mechanism is known as DNS-derived autoscaling.

If a DNS record for a hostname resolves to multiple IP addresses, and the number of addresses changes depending on the resources available, that change can be reflected in the nodes used in a pool. For example, backend.example.com might resolve initially to four IPv4 records, and then later resolve to six IPv4 records. The Traffic Manager updates the node list in the pool to include the new IP addresses.

The Traffic Manager performs updates at 30 second intervals.

To configure a pool to use DNS-derived autoscaling, click **Pools > Edit > DNS-derived autoscaling**. The following settings apply:

| Setting | Description |
|-------------------------|---|
| dns_autoscale!enabled | To enable DNS-derived autoscaling for a pool, set this key to Yes. By default, pools are not auto-scaled. |
| dns_autoscale!hostnames | A list of DNS hostnames that the Traffic Manager periodically queries. Any IPv4 A or IPv6 AAAA records are added or removed to this pool's list of nodes. |
| dns_autoscale!port | The port number the Traffic Manager appends to every node added using DNS-derived autoscaling. |

Service Discovery



Service Discovery is a license key controlled feature and is not available on all Traffic Manager variants. See the Ivanti Web site for details about supported configurations.

Traffic Manager pools can contain dynamic node lists populated and managed by a Service Discovery plug-in script. This ability allows you to configure your pools to be *autoscaled* by an external or remote service through a suitable script or program.



This feature is related to the Traffic Manager's built-in *autoscaling* capability. Although, through Service Discovery, a pool's node list is managed externally rather than internally. To learn more about pool autoscaling, see [Autoscaling](#).

To configure a new pool to use Service Discovery, set the pool type to **Dynamic...** and select a suitable Service Discovery Plug-in from the drop-down list:

Create a new Pool

Pool Name:

Pool Type: Static ...
 Dynamic ...

Pulse Secure vTM Autoscaler
 Service Discovery Plugin ...

Specify any arguments which should be passed to the script:

Monitor:

Alternatively, to convert an existing static pool to use a Service Discovery plug-in, click **Services > Pools > Edit > Service Discovery** and set **service_discovery!enabled** to "Yes":

▼ ⌘ Service Discovery Settings

These settings control how the Service Discovery plugin is called.

Are the nodes of this pool determined by a Service Discovery plugin? If yes, nodes will be automatically added and removed from the pool by the traffic manager.

service_discovery!enabled: Yes No

The plugin script a Service Discovery autoscaled pool should use to retrieve the list of nodes.

service_discovery!plugin:

The arguments for the script specified in "service_discovery!plugin", e.g. a common instance tag, or name of a managed group of cloud instances.

service_discovery!plugin_args:

The minimum time before rerunning the Service Discovery plugin

service_discovery!interval: seconds

The maximum time a plugin should be allowed to run before timing out. Set to 0 for no timeout.

service_discovery!timeout: seconds

The following settings enable you to further configure Service Discovery for your pool:

| Setting | Description |
|-------------------------------|---|
| service_discovery!enabled | <p>Turns Service Discovery on or off for a pool.</p> <p>You cannot enable Service Discovery if this pool is already using either Autoscaling or DNS-derived Autoscaling. If you are currently using either of these features for this pool, you must disable them before enabling Service Discovery.</p> |
| service_discovery!plugin | <p>The Service Discovery plug-in to use for this pool.</p> |
| service_discovery!plugin_args | <p>The arguments to pass to the plug-in, as a single string.</p> <p>All built-in plug-ins expect arguments in the form "--key1=value1 --key2=value2". For full details of the arguments required for each plug-in, see the Catalogs > Service Discovery Plugins catalog > Built-in Plugins UI Help page.</p> <p>For user-provided plug-ins, this setting is optional.</p> <p>For all plug-in types, this setting is not included in Technical Support Reports due to the possibility of security credentials being specified in the argument string.</p> |
| service_discovery!interval | <p>The poll interval for the plug-in, in whole seconds.</p> <p>This setting specifies the amount of time that must pass between each execution of the plug-in. If the previous execution has not finished, or timed out before the interval has elapsed, the plug-in does not run again until it has completed.</p> <p>To override this default interval with a temporary shorter interval, use the "interval_override" field in the plug-in response. For more information, see Custom User Plug-ins.</p> |
| service_discovery!timeout | <p>The timeout value for each execution of the plug-in.</p> <p>This setting specifies how long the Traffic Manager must wait before assuming a plug-in execution cycle has failed or halted.</p> |

| Setting | Description |
|---------|---|
| | In the event a plug-in does not complete execution within the timeout period, the pool continues to use the most recently-obtained list of nodes. |

Service Discovery plug-ins are standalone scripts or executable binaries which retrieve a list of nodes (active, draining, and disabled) from a remote service. A pool configured to use one of these plug-ins can update its nodes list based on the response from the plug-in.

Plug-ins are either *built-in* or *user-provided*, and stored in the "Service Discovery Plugins" catalog. To view the list of plug-ins, click **Catalogs > Service Discovery**.

Built-in Plug-ins

The Traffic Manager includes a number of predefined plug-in scripts designed to provide a dynamically-generated node list using the named external service. Each plug-in requires you to provide a series of input arguments in order to establish a connection to the service. These arguments are provided in the pool configuration and are unique to a specific pool. Hence, you can re-use the plug-in with multiple pools each obtaining their node list from a different instance of the external service.

The Traffic Manager provides the ability to test a connection in the plug-in catalog page. The required arguments are listed in the plug-in description in the form a list of `--argument=value` expressions. In the "Test Plugin" section, type an argument string into the **Arguments** text box, then click **Test** to test the connection.

The results of the test are displayed as soon as they are received.



Some plug-ins might require further software or tools to operate correctly. See the UI Help pages that accompany the plug-in for full details.

Custom User Plug-ins

The Traffic Manager includes the capability for adding custom service discovery plug-in scripts and programs. Plug-ins must be executable directly from a terminal (for example, a script starting with a "#!" line) and provide the node list in a specific format on STDOUT. The Traffic Manager does not use or respond to either the exit code or STDERR, although error reporting is possible through the script output format described in this section.

Ivanti recommends that you do not request user credentials or other sensitive information through the input arguments interface (**service_discovery!plugin_args**) in the pool configuration. If you need to pass in potentially sensitive argument values, consider instead using environment variables or a separate input file read from disk. Note, however, that plug-in arguments are not included in Technical Support Reports.

The Traffic Manager operates a specification version system for custom Service Discovery plug-ins. Each new Traffic Manager release might introduce a new specification version to take advantage of new features and better performance. Older specification versions continue to be supported until such a time as it becomes necessary to deprecate them for technical or support reasons. Ivanti communicates the currently-supported specification versions in the UI Help pages and through the product release notes. For full details, contact Pulse Secure Technical Support.

The script output must conform to a JSON structure, containing the following properties at the top level:

| Property | Type | Description |
|-------------------|------------|--|
| version | Integer | Required. The version of the plug-in specification this script conforms to. |
| code | Integer | Required. An HTTP status code to represent the status of the run. Use "200" for successful completion. |
| error | String | Optional. An error message to be printed to the Traffic Manager Event Log if the plug-in has failed in some way. |
| interval_override | Integer | Optional. Overrides the poll interval specified in the pool configuration with a smaller interval, until the next time the plug-in runs. If this value is larger than the configured pool interval, it is ignored. |
| nodes | Hash Array | Required. A list of nodes. The list of nodes contains: ip Required string. The address of the node. port Required integer. The port number of this node. |

| Property | Type | Description |
|----------|------|---|
| | | <p>weight</p> <p>Optional integer. A number used to represent the weighting to apply to this node, relative to all other nodes. Use this field if your service uses a weighted load balancing algorithm, such as <i>weighted round robin</i>. For more information, see Load Balancing.</p> <p>draining</p> <p>Optional boolean. Set to true to establish this node as being in a "draining" state.</p> <p>disabled</p> <p>Optional boolean. Set to true to establish this node as disabled and not accepting traffic. This can be useful as a default, or fall-back, position in your script, such that the pool is populated with a notional list of what nodes would be present in the event of an error.</p> |

The following JSON structure gives an example of a custom plug-in output:

```
{
  "version":1,
  "nodes":[
    { "ip":"192.0.2.0", "port":80 },
    { "ip":"192.0.2.1", "port":81, "draining":true }
  ],
  "code":200
}
```

Traffic IP Groups and Fault Tolerance

A cluster of Traffic Managers can distribute incoming network traffic between them, and transfer traffic shares from one to another if a Traffic Manager fails. Traffic distribution is configured by means of Traffic IP Groups.

The functionality referred to in this chapter might vary slightly depending on your product platform. For additional details and product specifications, see the Ivanti Web site at www.ivanti.com.

Fault Tolerance

Traffic IP Addresses and Traffic IP Groups

A "Traffic IP Address" is an IP address that must remain highly available. Traffic IP addresses are assigned to groups, called "Traffic IP Groups".

Each Traffic IP Group is managed by some of (or all of) the Traffic Managers in your cluster. They cooperate and share the traffic between them, ensuring that any traffic to the Traffic IP addresses is distributed between and managed by one of the Traffic Managers in the cluster.

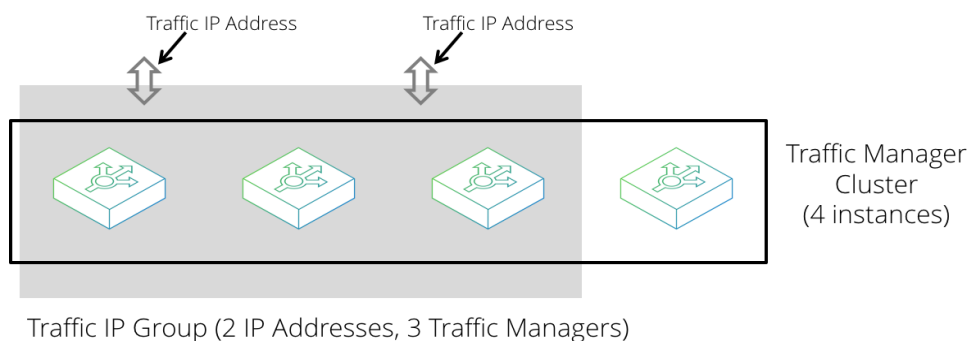

In the illustration above, a Traffic IP Group has been configured, spanning 3 of the 4 Traffic Managers in the cluster. This Traffic IP Group will manage the Traffic IP addresses, and the three Traffic Managers will ensure that those Traffic IP Addresses are available.

For example, a Web service might be published on IP address 34.56.78.90. You can ensure that the service is always available by adding that IP address to a Traffic IP group. The Traffic Manager cluster raises that IP address and manages all of the traffic to it. You would typically configure the DNS entry for your service to resolve to one or more Traffic IP addresses.

Distributing Traffic Within a Traffic IP Group

Traffic is shared between the Traffic Managers in your cluster using one of the following distribution policies:

- **Single-Hosted mode:** Each Traffic IP address is raised on one of the Traffic Managers in the group. If there are multiple IP addresses in the group, they are raised on different Traffic Managers, distributed as evenly as possible.
- **Multi-Hosted mode:** Each Traffic IP address is raised on all of the Traffic Managers in the group. Traffic to each IP address is evenly shared between all of the Traffic Managers.
- **Route Health Injection:** (not applicable to all product variants) Each RHI traffic IP group contains one active Traffic Manager, and optionally one passive Traffic Manager. All Traffic IP addresses in the group are raised privately (on loopback) by both participating Traffic Managers and dynamically advertised into the adjacent routing domain using OSPFv2 or BGP as the routing protocol. In response, routers direct all traffic to the active Traffic Manager.

Each Traffic Manager reports periodically to the others, and if one fails, the remaining Traffic Managers take over their share of traffic. In this way, services that depend on the Traffic IP addresses are always available.

For a discussion on example configurations of Traffic IP Groups, see [Example Configurations](#). To understand how to create a Traffic Manager cluster, see [Creating a Cluster](#).

Choosing Traffic IP Addresses

The Traffic Manager is typically attached to a front-end network for incoming traffic and a back-end network for back-end servers. At the IP level, these networks are described as IP subnets. For example, 192.0.2.0/24, 198.51.100.0/16, and so on.

For single-hosted and multi-hosted traffic IP groups, you must choose traffic IP addresses that are within these directly attached subnets. The Traffic Manager raises these IP addresses on the correct physical interface, so that routers and other devices on those networks can reach them directly.

For RHI traffic IP groups, you must choose traffic IP addresses that are not within these directly attached subnets. The Traffic Manager always raises RHI traffic IP addresses privately in their own /32 subnet on the Traffic Manager's internal loopback (lo) interface. Routers and other machines always send traffic to them indirectly, through the Traffic Manager's front-end IP address, according to routing information established using the OSPFv2 routing protocol.

The directly attached subnets are those you specify:

- When configuring a statically raised IP address on a particular interface.
- By adding an entry into the "Traffic IP Networks" table. For more information, see [Interface-to-Subnet Mapping \(Traffic IP Networks\)](#).

Creating a Traffic IP Group

To create a traffic IP group, click **Services > Traffic IP Groups**. On this page, you can create new traffic IP groups and edit existing ones.

Enter a name and select the Traffic Managers you want to be members of the group. Enter the traffic IP addresses for the group in a list separated by spaces or commas, choose the IP distribution mode if necessary, and click **Create Traffic IP Group**.

Traffic Distribution

The IP distribution mode determines how Traffic Managers in the same Traffic IP Group share the traffic between them.

You can configure traffic IP groups to raise traffic IP addresses on one Traffic Manager at a time (single-hosted mode), or on all Traffic Managers in the group simultaneously (multi-hosted mode). On some product variants, you can also select Route Health Injection as the distribution mode.

Single-Hosted Mode

Each IP address in the group is only raised on one Traffic Manager at a time. If the group contains more than one IP address, they are dispersed across the participating Traffic Managers. When a Traffic Manager fails, its traffic IP addresses are moved to the other working Traffic Managers in the group.

Set the **kepttogether** option for a traffic IP group to prevent dispersion of the IP addresses in the group. In this case, all traffic IP addresses are raised on the same Traffic Manager. This is useful when using traffic IP groups with IP Transparency. For details, see [Using IP Transparency with a Cluster](#).

Multi-Hosted Mode

Each IP address is raised on every machine at the same time. Incoming data for each IP is received by every Traffic Manager in the group, and each one takes responsibility for an equal portion of the incoming connections. If a machine fails, its portion is shared between the remaining active machines.

Multi-hosted IP addresses work by using multicast packets on your local network. The Traffic Manager advertises the traffic IP address using a multicast MAC address on the local subnet. This informs switches and routers that the traffic to the IP should be sent to all of the Traffic Managers. The MAC address used is calculated by providing a separate multicast group (represented as an IP between 239.0.0.0 and 239.255.255.255). This multicast group should be unique on your network.

Each Traffic Manager receives all incoming connections and makes a calculation based on the source IP address of the connection to determine whether it should accept that connection or if it should silently discard the connection (because another Traffic Manager in the group will accept it).

By discriminating on the source IP address alone, this method arranges that the same client will be processed by the same Traffic Manager (providing the client does not change IP address). This has the advantage that any session persistence data and SSL session data stored in the Traffic Manager will be available.

However, this can result in uneven distribution of traffic between Traffic Managers, particularly if your clients come from a small set of source IP addresses. This uneven distribution may impact the performance of the load-balanced service. If this is of concern, set the **consider source port** setting to instruct the Traffic Managers to distribute traffic based on the source IP address and port; this will share traffic much more easily across the cluster.

Note that using the source port may interfere with some session persistence methods, as there can be a short delay as the session persistence data is shared across the cluster (see [Using Session Persistence with Multi-Hosted Traffic IP Addresses](#)). Similarly, **consider source port** should not be used with any Traffic IP Addresses that are used by FTP virtual servers (see [FTP](#)).



If a Traffic Manager attempts to connect to a multi-hosted IP, the connection is always picked up by the local Traffic Manager itself.

Route Health Injection

The Traffic Manager uses front-end fault tolerance by announcing the Traffic IP addresses managed by the group out to the wider routing network. To use this method, the routers in your organization must be configured to use one of the following routing protocols:

- **OSPFv2:** Open Shortest Path First, version 2
- **BGP:** Border Gateway Protocol

You can only use RHI for IPv4 addresses; IPv6 is not supported.

Traffic IP Groups based on Route Health Injection (RHI) contain a maximum of two Traffic Managers, either with a single active Traffic Manager, or in a pair using an active-passive configuration.

When you select RHI as the distribution method, you additionally specify routing metrics for the active and passive Traffic Managers. When the Traffic Manager injects routes into the upstream routing network, these metrics determine the priority of the Traffic Manager instance within a multi-cluster (or multi-datacenter) scenario.

For more information, see [Route Health Injection and the Network](#).

Passive Machines

If you mark a Traffic Manager as passive then it will not raise any of the IP addresses (single-hosted mode) or handle any load (multi-hosted mode) in the Traffic IP group unless one of the non-passive Traffic Managers has failed.

When you add a Traffic Manager to an existing Traffic IP Group, some of the traffic may be transferred to the new Traffic Manager. Unavoidably, this will result in some dropped connections at the instant of transfer. To deal with this situation, you can add a Traffic Manager as passive. In that case, it will not take any traffic unless one of its peers was to fail.

Disabling a Traffic IP Group

You can disable a Traffic IP Group by de-selecting the **enabled** checkbox. Use this option to disable a group temporarily, but to retain the configuration for future reinstatement.

When a group is disabled, none of the IP addresses in the group are raised. Route advertisements for RHI traffic IP groups are withdrawn.

Interface-to-Subnet Mapping (Traffic IP Networks)

Prior to version 7.0 of the Traffic Manager, there was a pre-requisite to hosting a Traffic IP Address of having an interface that is configured with an IP address in the same subnet. This pre-requisite provides a benefit because it allows a Traffic Manager to automatically figure out which devices can host a Traffic IP Address (based on the routing table and "health" of the interface). The drawback to this is that it means you end up with an IP address that does not actually receive any traffic, but still takes up space. This can be frustrating if the network you want to receive traffic in is small (say, a /29 for example). The interface-to-subnet mapping feature gives you a way to define an explicit mapping of subnets to interfaces. When in use, you do not need to configure an interface with an IP address in a particular subnet just to host a Traffic IP Address on it.

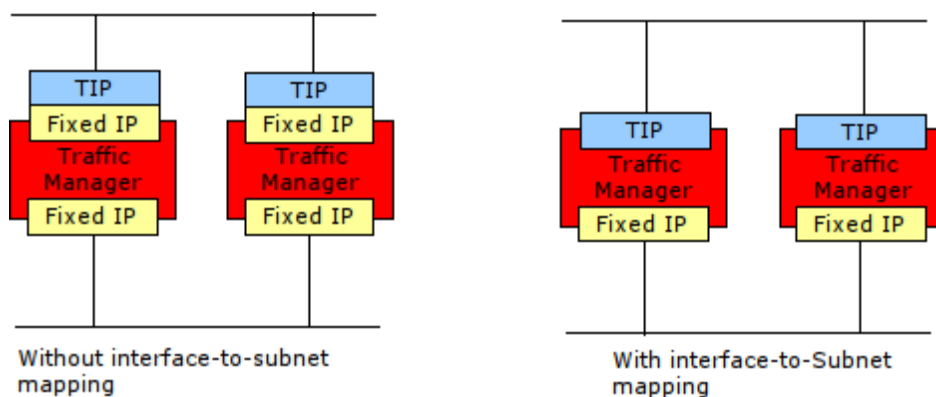

To configure a Traffic IP Network

1. Navigate to the **Services > Traffic IP Groups** page.
2. In the "Traffic IP Networks" section, click the **Network Settings** link.
3. In the **Add Network** field, using CIDR notation, enter the IP subnet that you want to host IP addresses in. For example, 192.168.50.0/24.
4. From the **Default Interface** drop-down box, select the network interface that you want this subnet to be hosted on.



The Traffic Manager prevents the use of DHCP-enabled network interfaces for hosting Traffic IP addresses. Use only interfaces configured with static networking for your Traffic IP subnet.

5. Click **Update** to save your changes.

After configuring a Traffic IP Subnet on the desired interface, you will see a dialogue box appear that allows you to configure which interfaces should be used for the same subnet on the other Traffic Managers in the cluster.

Configuring Fault-Tolerance

The Traffic Managers in a cluster periodically check that they can communicate with the network using ICMP pings through each active network interface. They then broadcast a message describing their health (good or failed).

If one of the Traffic Managers in a cluster fails, the other Traffic Managers will take over any Traffic IP addresses that the failed Traffic Manager was managing.

Fault Tolerance Configuration Settings

You can configure fault tolerance using the settings in **System > Fault Tolerance > General**:

- **flipper!autofailback**: If a Traffic Manager that is hosting Traffic IP addresses fails, another Traffic Manager in the cluster raises the dropped addresses until the original Traffic Manager recovers.

Set to "Yes" to ensure that the Traffic IP addresses are automatically returned to the original Traffic Manager when it regains connectivity.

Set to "No" to force the original Traffic Manager into a pending mode upon recovery, in which case it waits to be instructed when it should raise the Traffic IP addresses.

The Admin UI displays a warning when a Traffic Manager is in the pending state. Use the **Diagnose > Cluster Diagnosis** page or the **Services > Traffic IP Groups** page to fully reactivate a pending Traffic Manager.



A pending Traffic Manager is automatically reactivated if all other Traffic Managers in the cluster fail. In this case, the Traffic Manager also takes over all Traffic IP addresses it is responsible for. A Traffic Manager also reactivates automatically if it would not cause any disruption to the services already running.

-
- **flipper!autofailback_delay**: The time interval, in seconds, after which a recovered Traffic Manager should re-raise dropped Traffic IP addresses.

If **flipper!autofailback** is set to "Yes", a previously-failed cluster member has to remain healthy for this period of time before failback can occur. This mechanism can help to ensure a recovered Traffic Manager is not still subject to some external factor blocking connectivity before it is required to raise Traffic IP addresses. If, during the waiting period, a further failure is detected, the delay timer restarts.

Manual failback is possible at any time during delayed auto-failback. To perform a manual failback, reactivate a pending Traffic Manager on the **Diagnose** page.

Changing the value of **flipper!autofailback_delay** has no effect on an already running delay timer until the timer is forced to restart through either a subsequent failure or a successful failback event. To enforce an immediate change, or just to cancel the current timer, disable auto-failback by setting **flipper!autofailback** to "No". If you then re-set **flipper!autofailback** to "Yes", the new delay period applies. Setting **flipper!autofailback_delay** to 0 (zero) in this situation stops a running timer and results in immediate failback.

Turning off auto-failback during a delay timer countdown always prevents a Traffic Manager from being used, even if the system had previously entered a healthy state and the delay timer was running.

- **flipper!monitor_interval**: The time interval, in milliseconds, that the Traffic Manager uses to periodically check if it can contact other devices on the network. The result is then announced to other Traffic Managers on a multicast address. Decrease the interval to ensure failures in the network are detected sooner, however this increases the workload on the system.
- **flipper!monitor_timeout**: The amount of time, in seconds, that the Traffic Manager should wait for a response when it has tried to contact one of the devices used to check connectivity. If a response is not received within this time, the Traffic Manager assumes it cannot contact the device. Decrease this value to allow the Traffic Manager to detect failures sooner, although the reliability of the system is reduced because slower connections might be incorrectly regarded as having failed.
- **flipper!heartbeat_method**: In a cluster, each Traffic Manager must send out periodic heartbeat messages to advise that all software and network services are running.

Use Unicast to instruct the Traffic Manager to send directed UDP messages to each Traffic Manager in your cluster. Use this setting if the switches in your network are unable to handle the potentially more efficient multicast packet method. Unicast messages can also reach machines on separate subnets; for example, Traffic Managers in disparate data centers. Use **Communication Port**: to specify the network port the Traffic Manager must listen on for unicast messages. This port must be contactable from all other Traffic Managers in the cluster.

Use Multicast to instruct the Traffic Manager to send these messages using multicast network packets, which should traverse all network ports on all switches that your Traffic Managers are connected to. Multicast messages only reach machines on the same subnet. Set the multicast address that all Traffic Managers should listen on using the **Multicast address and port:** field (by default, this is 239.100.1.1:9090).

- **flipper!use_bindip:** Should multicast messages be sent and received on the management interface alone.

Set this to “Yes” if your Traffic Managers communicate with each other on a separate, dedicated network to that used by the main traffic. Note that, however, the reliability of the system could be compromised as a result.

Set this to “No” (default) to instruct the Traffic Manager to send the multicast messages it uses to announce its connectivity out over every network interface. This increases the reliability of the system by ensuring that failure of one network interface does not cause other Traffic Managers in the cluster to assume that this machine has failed.

- **flipper!arp_count:** The number of ARP packets that the Traffic Manager sends when a network interface is raised. Although other devices on the network only requires one ARP request to acknowledge a new interface on a Traffic Manager, ARP packets can get lost or missed. To improve the reliability and speed of the broadcast, the Traffic Manager sends the number of ARP packets defined here when an interface is raised.
- **flipper!igmp_interval:** The time interval, in seconds, that the Traffic Manager uses to sends unsolicited IGMP Membership Report packets for Multi-Hosted Traffic IP groups. Use this interval to prevent switches and routers from forgetting the Traffic Manager’s multicast subscription(s). To disable this feature, set the interval to 0.
- **flipper!verbose:** Should a Traffic Manager log all connectivity tests. Set this to Yes to output detailed information to the system log.



Ivanti recommends only using this for diagnostic purposes.

- **flipper!frontend_check_addrs:** The IP addresses to use for front-end connectivity checking. If the Traffic Manager cannot successfully ping these addresses, it decides that its network connectivity is broken and performs fail-over to the other Traffic Managers in the cluster.

If your Traffic Manager setup does not require external connectivity; for example, if it is part of an Intranet, set this field to blank to disable the external connectivity check.

Understanding Traffic Manager Fault Tolerance Checks

Each Traffic Manager checks that its network interfaces are operating correctly. It does this by:

- Periodically pinging the default gateway, to ensure that its front-end network interface is functioning.
- Periodically pinging each of the back-end nodes in the pools that are in use, to ensure that its back-end network interfaces are functioning.

The Traffic Manager concludes that it has failed if it cannot ping the default gateway, or if it cannot ping any of the nodes in any of the currently used pools.

Overriding Front-End Checks

You might need to override the front-end check if, for example, your gateway does not respond to ICMP pings. To override the front-end check, set **flipper!frontend_check_addrs** to an empty string.

Health Broadcasts

Each Traffic Manager regularly broadcasts the results of its local health checks, whether it is healthy or not.

By default, each machine broadcasts these heartbeat messages twice per second. You can configure this behavior using the **flipper!monitor_interval** setting.

You can choose to send broadcast messages by one of two methods, unicast or multicast. Select your preference with the **flipper!heartbeat_method** setting.

If you use unicast, you must ensure that "State Sharing" is enabled. To do this, set **state_sync_time** on the **System > Global Settings** page to a non-zero value.

In many circumstances, unicast is appropriate. However, if your network setup means that all Traffic Managers can receive multicast messages, for example, if your Traffic Manager cluster is within a single network segment, use multicast instead. If, after trying both methods, you still encounter issues, contact your support provider for assistance.



Ivanti recommends that users of Hyper-V-based Traffic Managers use the default unicast method. When two or more instances are clustered together, using multicast can, in some circumstances, result in packet loss.

To debug heartbeat communication problems, Ivanti recommends using the “tcpdump” program to capture all heartbeat messages on your network:

```
# tcpdump -i eth0 ip multicast
```

To capture only the heartbeat messages issued by your Traffic Managers, use:

```
# tcpdump -i eth0 dst host 239.100.1.1 and dst port 9090
```



This example uses port 9090, the default for Traffic Manager management communications. Substitute in the port number your Traffic Manager uses, if different. For more information on the Traffic Manager’s network port requirements, see [Default Ports Used by the Traffic Manager](#).

Determining the Health of a Cluster

Each Traffic Manager listens for the health messages from all of the other Traffic Managers in the cluster. A Traffic Manager concludes that one of its peers has failed if any one of the following conditions is true:

- It receives an "I have failed" health message from the peer.
- It does not receive any messages from the peer within the value set in **flipper!monitor_timeout**.
- The peer reports that one of its child process is no longer servicing traffic. This occurs if any child process fails to respond within the value set in **flipper!child_timeout**.

The Traffic Manager concludes that a peer has recovered when it starts receiving "I am healthy" messages from the peer.

Failover

When each Traffic Manager in a cluster determines that one of its peers has failed, the Traffic Manager may take over some or all of the traffic shares that the failed system was responsible for. The traffic distribution method determines how this is done.

Traffic IP Address Transfer (Single-Hosted Mode)

Each Traffic Manager in a cluster uses its knowledge of which machines are active to determine which Traffic IP addresses it should be running. The cluster uses a fully deterministic algorithm to distribute IP addresses across the machines:

- Because the algorithm is deterministic, the Traffic Managers do not need to negotiate between themselves when one of their peers fails or recovers.
- The algorithm is optimized to spread the distribution of Traffic IP addresses across the active Traffic Managers in a cluster, and to minimize the number of IP address transfers if a Traffic Manager fails or recovers.

When a Traffic Manager raises a Traffic IP address, it sends several ARP messages to inform adjacent network devices that the MAC address corresponding to the IP address may have changed. The Traffic Manager will send up to 10 ARP messages (tunable using the **flipper!arp_count** setting); the frequency of these messages is controlled by the **flipper!monitor_interval** setting (by default, the messages are sent at 0.5-second intervals).

Note that if a Traffic Manager detects that its own network connectivity has failed, it will immediately drop its Traffic IP addresses and broadcast I have failed health messages to its peers. This is in anticipation of other Traffic Managers in the cluster raising the interfaces when they realize that the first Traffic Manager has failed.

Traffic IP Address Transfer (Multi-Hosted Mode)

Each Traffic Manager in the Traffic IP Group deterministically chooses whether or not it should handle each packet, based on the source IP of that packet (and optionally the source port; see [Traffic Distribution](#)).

If a Traffic Manager fails, its share of the load is spread evenly between the remaining Traffic Managers. When it recovers, it takes equal shares of the load from its peers, thus ensuring that the traffic is always evenly distributed across the working machines in the Traffic IP Group.



Multi-hosted IP functionality is not included with the Traffic Manager software by default. You can download and install it as an additional kernel module, and is supported on Linux kernels, version 2.6.18 and later. See the Traffic Manager documentation on the Ivanti Web site (www.ivanti.com) for more information on supported versions.

Traffic IP Address Transfer (RHI Mode)

If a Traffic Manager's fault tolerance checks fail, it lowers the addresses used in RHI traffic IP groups and withdraws route advertisements from the network.

If the network detects an inability to reach the designated active Traffic Manager in an RHI traffic IP group, routing decisions for the traffic IP address(es) use instead the next best available route using the lowest metric, such as to the designated passive Traffic Manager, or to a Traffic Manager hosting the same traffic IP address in another datacenter.

Recovering from Failure

When a failed Traffic Manager recovers, its share of traffic is transferred back to it.

Each time traffic shares are transferred from one Traffic Manager to another, any connections currently in that share are dropped. This is inevitable when a transfer occurs because a Traffic Manager fails, but may not be desirable when a Traffic Manager recovers.

In this case, you can disable the **flipper!autofailback** setting on the **System > Fault Tolerance** page of the Admin UI. When this is disabled, a Traffic Manager does not take any traffic when it recovers. Instead, the user interface displays a message indicating that the Traffic Manager has recovered and can take back its IP addresses.

When you want to reactivate the Traffic Manager, go to the **Diagnose** page and select the **Reactivate this** Traffic Manager link.

Alternatively, you can edit each of your traffic IP groups and set the recovered Traffic Manager to passive. Once you set it to passive in all of the groups, it will not need to take any shares of traffic; it will then reactive automatically, clearing the error state. In addition, no traffic will be lost because not traffic shares will have been transferred.

Debugging and Monitoring Fault Tolerance Activity

All state changes and IP address transfers are logged in the event logs of each relevant Traffic Manager. If email alerting is correctly configured (see [Event Handling and Alerts](#)), the Traffic Manager also sends an email message describing the state change and any IP address transfers that resulted to the system administrator.

For detailed debugging, enable the **flipper!verbose** setting. This causes each Traffic Manager to log every single connectivity test, broadcast message sent and broadcast message received, and is useful when determining why the fault tolerance behavior is not as expected.

See also the **Cluster Diagnosis** page in the **Diagnose** section of the Admin UI. This page informs you if any broadcast messages are not being received correctly, and provides a summary of the system status if an error has occurred.

For detailed information on your Route Health Injection status, see the **Diagnosis > Routing** page of the Admin UI.

Configuring BGP Connectivity

You can configure your Traffic IP Groups to use RHI as the IP distribution mode, using BGP as the routing protocol. To enable RHI for your Traffic IP addresses, use the **Services > Traffic IP Groups** page.

The settings in **System > Fault Tolerance > BGP Route Health Injection** control BGP connectivity between Traffic Managers in your cluster and the neighboring routing infrastructure:

- **bgp!enabled:** Whether BGP Route Health Injection is enabled.
- **bgp!as_number:** The Autonomous System (AS) in which your Traffic Manager cluster operates. Use a decimal value to represent the AS. This number applies to all Traffic Managers in your cluster (or each Configuration Location within a Multi-Site Manager cluster; see [Multi-Site Cluster Management](#)).

Configuring BGP Router IDs

By default, each Traffic Manager in the cluster joins the BGP routing domain using the address and subnet by which it is connected to its IPv4 default gateway. To override this behavior, you can set an alternate ID for each cluster member individually using **flipper!bgp_router_id**.

Managing BGP Neighbors

Unlike with OSPFv2, the Traffic Manager is unable to automatically discover its BGP neighbors. To enable your cluster to establish BGP sessions, you must first define the neighboring routers and then create applicable mappings between each cluster member and the desired neighbor.

To manage the BGP neighbors you can use in this mapping, click **Manage BGP Neighbors**. Use this page to define a new neighboring BGP enabled router, and to modify the parameters for existing neighbor definitions.

For each new router, input the following BGP connection parameters:

| Field | Description |
|-------------------------|--|
| BGP Neighbor name | An identifying name |
| IP Address | The IPv4 address of the neighbor |
| AS Number | The AS number for this neighbor. This might be the same AS as your proposed corresponding Traffic Manager (in which case the session uses iBGP), or it might be a different AS altogether (in which case the session uses eBGP). |
| Keepalive | The interval, in seconds, between health message transmission. |
| Holdtime | The minimum interval, in seconds, that must elapse after the last received keepalive before this neighbor assumes the mapped Traffic Manager is no longer active. |
| Advertisement Interval | The interval, in seconds, that must elapse between advertisements made to this neighbor. |
| Authentication Password | (optional) The per-BGP session password that your mapped Traffic Manager must use with this neighbor. Linux kernel versions earlier than 2.6.20, or any kernel built without the relevant option (CONFIG_TCP_MD5SIG) enabled, might not support this setting. For further clarification, see your system administrator or support provider. |

After you have defined your BGP neighbors, click back to the **System > Fault Tolerance** page to create the mappings to your individual Traffic Managers.

Before you can use BGP, you must configure the neighboring BGP routers to establish sessions with the selected Traffic Managers. This effectively corresponds with the neighbor definitions you have just created at the Traffic Manager end of the connection.

Click **Update** to apply your mappings and configuration. The settings on this page are replicated across all members of the Traffic Manager cluster.

The Traffic Manager reports all router peering and connection failures in the event log. The applet in the Admin UI and the Diagnose page both reflect the current status.

Configuring OSPFv2 Connectivity

You can configure your Traffic IP Groups to use RHI as the IP distribution mode, using OSPFv2 as the routing protocol. To enable RHI for your Traffic IP addresses, use the **Services > Traffic IP Groups** page.

The settings in **System > Fault Tolerance > OSPF Route Health Injection** control OSPFv2 connectivity in your Traffic Manager cluster:

- **ospfv2!enabled:** Whether OSPFv2 Route Health Injection is enabled.
- **ospfv2!area:** The OSPFv2 area in which your Traffic Manager cluster operates. You can use a decimal or IPv4 address format.
- **ospfv2!area_type:** The type of OSPFv2 area in which your Traffic Manager cluster operates. OSPFv2 requires all routers in a specific area to use the same type.
- **ospfv2!hello_interval:** The interval at which the Traffic Manager sends OSPFv2 "hello" packets to the network.
- **ospfv2!router_dead_interval:** The number of seconds that must elapse before the Traffic Manager declares a silent router down.



If you disable OSPFv2, or shut down the Traffic Manager, it first de-advertises Traffic IP addresses by sending out a MaxAge Link State Advertisement (LSA) to all adjacent routers.

The Traffic Manager supports the use of two separate OSPFv2 authentication key/secret pairs ("a" and "b"). This mechanism enables you to maintain authentication across your network infrastructure in the event of your needing to replace one of the key/secret pairs. When updating the authentication key in use, you can keep the old key active until the new key has been provisioned across the network.

The Traffic Manager supports OSPFv2 authentication types 0 (none) and 2 (MD5). MD5 is used when at least one active key is configured.

- **ospfv2!authentication_key_id_a:** The OSPFv2 authentication key ID. Set to 0 to disable the key.
- **ospfv2!authentication_shared_secret_a:** The OSPFv2 authentication shared secret (MD5). Set to blank to disable the key.

- **ospfv2!authentication_key_id_b**: The OSPFv2 authentication key ID. Set to 0 to disable the key.
- **ospfv2!authentication_shared_secret_b**: The OSPFv2 authentication shared secret (MD5). Set to blank to disable the key.



If both key pairs are set to 0 (disabled), the Traffic Manager does not use OSPFv2 authentication.

The Traffic Manager does not act as a general purpose OSPFv2 router.

Configuring OSPFv2 IP Addresses

By default, each Traffic Manager in the cluster joins the OSPFv2 routing domain using the address and subnet by which it is connected to its IPv4 default gateway. To override this behavior, the Admin UI provides the means to set an alternate IPv4 address for each cluster member individually using **flipper!ospfv2_ip**.

The individual IP addresses you specify are used by each Traffic Manager as the next hop addresses for OSPFv2 routes that are installed on neighboring routers for traffic IPs that the Traffic Manager is advertising.

Set **flipper!ospfv2_ip** to "0.0.0.0" to disable the Traffic Manager's routing software.

Configuring Neighborhood Monitoring

The Traffic Manager polls the routing network every 10 seconds to collect neighborhood data. Among this data is a list of routers the Traffic Manager is peered with. For OSPF, this is known as the "neighbor list".

To perform neighborhood monitoring, you configure each Traffic Manager in your cluster with the list of neighboring router IP addresses from which it should expect to receive traffic. This list is compared to the discovered neighbor list in order to determine the health of the routing network.

To configure the expected neighbors, type a space or comma separated list of IPv4 addresses in **flipper!ospfv2_neighbor_addrs**. Use the default value %gateway% to mean the default IPv4 gateway that each Traffic Manager is connected to.

To disable neighborhood monitoring for a specific Traffic Manager, set **flipper!ospfv2_neighbor_addrs** to an empty list.

The Traffic Manager reports a warning in the event log if some of the expected routers are not peered, and reports an error if none of the expected routers are peered. The applet in the Admin UI and the Diagnose page both reflect the status at the last poll.



Due to the latency involved in establishing peering, you might experience transient warnings or errors if you modify your OSPF configuration.

Key Features in the Traffic Manager Administration Interface

This chapter describes the main features of the Traffic Manager Admin UI.

The Home Page

The Home Page of the Traffic Manager Administration Interface provides a dynamically updating overview of your key configuration, traffic and status:

- The “Status Applet” displays a real-time indication of the health status of the cluster, and a real-time traffic chart and summary. If a problem of any kind is detected, the status light in the applet will change from green to either orange (a minor problem) or red (a major problem). Click the status light to go directly to the **Diagnosis** page.
- The “Login Information Banner” provides a record of the previous successful login using these credentials. Any previous failed attempts are also shown here.
- The “Traffic Managers” section displays the status of the traffic management devices in your cluster. If any of the devices develops a fault, it will be highlighted and an error message displayed.
- The “Services” section displays a list of the services you are managing; the protocol, port, virtual server name and a list of all pools used by the service . The **Stop** and **Start** buttons can be used to stop or start a service. If any problems are detected with a virtual server or pool, these will be highlighted.
- The “Event Log” section displays the most recent event log messages from the Traffic Manager systems in your cluster. Click **Examine Logs** to display the full event log. For more information, see [The Event and Audit Logs](#).

The home page updates automatically to show new event log messages and changes in Traffic Manager, virtual server, or pool status.



The Traffic Manager presents an adapted home page layout in multi-cluster management mode, including an additional section for your configured Locations. For full details, see [Multi-Site Cluster Management](#).

Services > Configuration Summary

With a number of virtual servers, pools and rules set up, your configuration can soon become complex. The "Config Summary" provides a single-page synopsis of the items you have configured and how they connect together.

To view the Configuration Summary, click **Services > Config Summary**. Your services are displayed in a table, initially grouped by port and virtual server, with each of the items used by the service displayed alongside.

You can rearrange the table to focus in on a particular column or configuration object, and see clearly what configuration objects depend on it. For example, clicking on the **Pool** column shows you each pool name, and beside it the nodes it contains, and the virtual servers and rules that use it.

This allows you to track exactly where each configured item is used in a complex setup.

Exporting a Configuration Archive

Use the **Export Configuration** option to download an archive file containing the current running configuration to your local machine. To restore a previously-saved configuration archive file, use the **System > Backups** page. For more information, see [System > Backups](#).

ATTENTION

Store this backup securely. It contains sensitive information, including SSL certificates.

Exporting a Configuration Document

The Traffic Manager includes a tool called the Configuration Importer, used to import a complete system configuration into a Traffic Manager instance from a previously-created definition - typically within an orchestration tool such as Docker or Kubernetes. Such definitions are contained within text files called *configuration documents* and the Configuration Importer uses these documents to construct the definitions on the local Traffic Manager, replacing its previous running configuration.

Use the "Export Configuration document" section to create and export a configuration document based on the current running configuration.

For a complete description of this functionality, see the *Pulse Secure Virtual Traffic Manager: Configuration Importer Guide*.

Catalogs

The Catalogs are central repositories of objects, and classes of objects, that you can use for managing traffic. You can store the following object types:



Some catalog types might be license dependent. See the Ivanti Web site (www.ivanti.com) for more information.

- **Locations catalog:** Contains location-based configuration objects used for Global Load Balancing (GLB) and the Traffic Manager's multi-site cluster management capability.
- **DNS Server:** Contains zonefiles and zone configurations used with the Traffic Manager's authoritative Domain Name Server (DNS) capability.
- **GLB Services catalog:** Contains GLB service configurations used by the Traffic Manager to load balance clients across different geographic locations.
- **Service Discovery Plugins catalog:** Contains scripts used by a pool to retrieve a remotely-autoscaled list of back-end nodes.
- **Web Accelerator catalogs:** Contains application scopes and profiles used by Ivanti Web Accelerator.
- **Rules catalog:** Contains TrafficScript and RuleBuilder rules.
- **Java Extensions catalog:** Contains Java Extensions and any supporting Java class files that the extensions require. These Java Extensions can be invoked from a TrafficScript rule.
- **Monitors catalog:** Stores health monitors you can use to check the correct operation of nodes in a pool.
- **SSL catalogs:** Contains SSL resources: server and client certificates, certificate authorities and certificate revocation lists.
- **Authenticators catalog:** Contains definitions of remote LDAP authentication services. These services can be accessed from TrafficScript to look up information about a user and to verify their password.
- **Kerberos catalog:** Contains configuration resources needed by the Traffic Manager to allow it to participate in Kerberos realms.
- **SAML catalogs:** Contains resources used by the Traffic Manager to participate in SAML-based single sign-on authentication.

- **Service Protection classes:** holds classes that define the policies and security measures used by the Traffic Manager to filter unwanted traffic.
- **Session Persistence classes:** Contains classes that manage session persistence information for client connections.
- **Bandwidth classes:** Contains bandwidth allocations that you can use to manage bandwidth usage.
- **Service Level Monitoring classes:** Contains classes that monitor node response time and conformance to agreed levels of service.
- **Rate Shaping classes:** Contains classes you can use to queue and rate-shape requests to impose maximum request rates.
- **Cloud Credentials classes:** Holds the information required to allow the Traffic Manager to communicate with cloud provider APIs.
- **Extra files:** Contains additional files and resources accessible from TrafficScript rules (using `resource.get()`), or used to provide error messages in pool configuration.

Virtual servers, pools and rules can each reference objects in the Catalog. If you edit an item in the catalog, the changes you make propagate to every service that uses the item.

To access the catalogs, click **Catalogs** in the top navigation bar. To edit or add to the items in a catalog, click the appropriate **Edit** link.

Each catalog type is described in more detail later in this document.

License Management

Traffic Manager documentation and product interfaces often make reference to the use of license keys to enable or disable product features and capabilities. Ivanti (or your designated support provider) generates these keys on a case-by-case basis, and such keys are normally tied to your specific product instance or service agreement.

For clusters of multiple Traffic Manager instances, you should obtain a suitable key (or set of keys) to cover the licensing requirement of the whole cluster. Unlicensed Traffic Managers operate with restricted performance as the Community Edition. For more information, see [The Traffic Manager Community Edition](#).

ATTENTION

Although having differently licensed Traffic Managers within a single cluster is possible, Ivanti does not recommend this due to the potential for automatic cluster synchronization failure when unlicensed features on one or more cluster members have updates attempted upon them.

To view your currently installed license keys, click **System > Licenses**. This page displays each license key, identifiable by its serial number, and the Traffic Managers it is valid for. To view full details for a specific license, such as product variant, expiry date, and licensed feature set, click the fold-down arrow.

When multiple licenses are installed on a Traffic Manager instance, the Traffic Manager selects the license to use based on the following ordered criteria:

- Any installed license is preferred over the default, unlicensed, Community Edition.
- Any authorized license is preferred over non-authorized licenses.
- Remotely authorized licenses (including Flexible License Architecture (FLA) type licenses) are preferred over non-remote licenses (perpetual licenses).
- A license with a richer set of features is preferred over a license with a lesser set.

Adding and Removing License Keys

The first time you access the Admin UI of a newly-installed and configured Traffic Manager, you are presented with an “Unlicensed” page. This page provides the opportunity to either upload a license key or continue to use the Community Edition. Traffic Manager hardware appliances, virtual appliances, and certain cloud instances also provide the opportunity to upload licenses through the Initial Configuration wizard. For more details, see the version of the Pulse Secure Virtual Traffic Manager: Installation and Getting Started Guide most applicable to your product variant.

Beyond this, the **System > Licenses** page is the location to add and remove individual keys. New licenses can be uploaded using the “Install new License Key” section at the foot of the page. Click **Choose File** to provide the location of a standard text file containing the license data, and then click **Install Key**. If this operation is successful, your new license will appear in the list.

Unneeded or invalid keys present in the cluster can be removed by selecting the checkbox to the right of the offending license and clicking the **Remove Selected Keys** button. If you attempt to remove a key that will result one or more Traffic Managers becoming unlicensed, the Traffic Manager warns you of this and requires you to confirm the action by overriding the warning. If you choose to proceed, the affected Traffic Managers become Community Editions.

Registering with Pulse Secure Services Director

The Traffic Manager can send a registration request to a Services Director instance for remotely-managed flexible licensing. This capability is referred to as self-registration and is typically enabled at initial configuration, at which time you input the details of the Services Director instance with which you want to register your newly-configured Traffic Manager. The Services Director then uses the REST API of the Traffic Manager to query and issue configuration updates.



To learn more about Pulse Secure Services Director, see the Ivanti website at www.ivanti.com.

To register your Traffic Manager with a Services Director, click **System > Licenses > Services Director Registration**. Use the fields on this page to manually issue a registration request to a Services Director instance.

After the registration request is initiated, the Traffic Manager waits for the Services Director Administrator to approve or decline the request. If the request is approved, the Services Director pushes a suitable license to the Traffic Manager. To view status messages pertaining to the registration request, see the Event Log.

Enter your registration details in the form provided, according to the following requirements:

| Field | Description |
|---|---|
| remote_licensing!registration_server | The address, including port number, of the Services Director with which you want to register this Traffic Manager. For a Services Director VA, use the Service Endpoint Address. |
| remote_licensing!server_certificate | The server certificate of the Services Director, in a PEM-encoded format. This is automatically updated by the Services Director when the certificate is renewed. |
| remote_licensing!owner | The Owner you want to be associated with this Instance, if using auto-acceptance. |
| remote_licensing!owner_secret | The Owner secret, used to verify the identity of the Owner specified in remote_licensing!owner . |

| Field | Description |
|--|---|
| | This field is applicable only if using auto-acceptance of registration requests, and the <code>validate_owners</code> setting on the Services Director is true. |
| remote_licensing!policy_id | The auto-acceptance/registration policy ID to attempt to use for auto-acceptance. |
| remote_licensing!comm_channel_enabled | <p>Whether communication with the Services Director should be channeled through the Communications Channel Agent.</p> <p>The Communications Channel Agent uses a long-lived TLS-encrypted websocket connection to handle bidirectional communications between a Traffic Manager and a Services Director. This is required for Traffic Manager instances behind a NAT gateway or other network boundary that impedes the Services Director's ability to communicate directly with a Traffic Manager's REST API. For example, when deploying the Traffic Manager inside of a container.</p> <p>Your Traffic Manager event log might display Communications Channel Agent connection failure warnings up until the Traffic Manager registration request is properly approved by the Services Director. The Traffic Manager retries the connection attempt once per second, although only shows connection failure message once every 15 seconds to reduce log clutter.</p> <p>A self-registration request to a Services Director which does not support the Communications Channel Agent feature automatically sets this value to "No".</p> <p>This facility is available only for Traffic Managers that perform self-registration with the Services Director. Traffic Managers added manually on the Services Director cannot use this feature.</p> |

| Field | Description |
|---|--|
| remote_licensing!comm_channel_port | The port for the Communications Channel Agent running on the Services Director. The default value is 8102. |
| remote_licensing!email_address | (Optional) An e-mail address at which the Services Director Administrator can contact you. |
| remote_licensing!message | (Optional) A free-form message to be included with the registration request, and visible to the Services Director Administrator. Use this field to provide additional identifying information for your registration request, if needed. |

To send the registration request, click **Save and Register**.

A saved update to any of the fields in this section automatically triggers re-registration with the named Services Director. To manually request re-registration without altering the configuration, click **Re-register**.



To instruct the Services Director to treat a self-registration as if it were the first registration, regardless of previous attempts, tick the **Force** checkbox.

System > Global Settings

The Traffic Manager software provides an extensive set of configurable global settings. You can access these by clicking **System > Global Settings**. They cover aspects of the Traffic Manager that are not related to individual services or traffic, and are divided into the following categories:

| Category | Description |
|----------------------|--|
| System Settings | Define the network and system settings for each Traffic Manager. |
| EC2 Account Settings | Control how the Traffic Manager interacts with the Amazon EC2 API. |
| Cache Settings | Control the behavior of the shared caches in each Traffic Manager. |

| Category | Description |
|--------------------------------|---|
| FIPS 140-2 Configuration | Determines whether "FIPS Mode" is enabled. This mode allows the Traffic Manager to process traffic using a FIPS 140-2 cryptographic module. |
| SSL Configuration | Control the behavior of the SSL support. |
| SSL Hardware Support | Apply to any additional SSL hardware used by the Traffic Manager. |
| Logging | Control how the Traffic Manager performs logging for system events and virtual server access. |
| State Synchronization Settings | Control how cluster members share their state data. |
| Idle Connection Settings | Control how idle HTTP connections to nodes are managed. |
| Java Extension Settings | Control how the Java Extension process is initialized and managed. |
| Login and Security Settings | Control user login behavior (see Login Security and Behavior). |
| Web Accelerator | Control global properties for Ivanti Web Accelerator. |
| Enterprise Authentication | Controls the behavior of SAML-based enterprise authentication in your services (see Providing Authentication for your Services). |
| Telemetry | Controls the optional reporting of anonymous usage data to Ivanti. This data facilitates product improvements and enhances Ivanti's ability to provide technical support. |
| Other Settings | Control other miscellaneous Traffic Manager settings. |

Clicking on the arrow beside each category unfolds the options for that category. When you have finished making changes, click the **Update** button. You can use the **Restore Defaults** button to restore all the global settings to the system defaults.

ATTENTION

Take care when modifying any of these settings. The default values have been chosen to give good performance on a wide range of systems, and to preserve the stability and security of the software. Configuring these settings incorrectly could compromise the stability and security of your system, and may impact performance.

System > Backups

You can use the Traffic Manager's Backup Management capability to make backups of your configuration, compare backups with each other and with the current configuration, and restore configuration from a previous backup.

To manage your configuration backups, click **System > Backups**.

You can also use the "zconf" command-line utility to perform a more fine-grained backup/import/export of individual configuration objects. For more details, see [Granular Configuration Import/Export with zconf](#).

Ivanti recommends you make a backup of your configuration before making a large configuration change, so that you can:

- Compare configurations to find out exactly what you have changed.
- Restore the earlier backup if you wish to abandon the changes you have made.

This feature also enables you to copy configuration backups from one Traffic Manager machine to another if, for example, you want to replace an older virtual machine or cloud instance with a newer version.

ATTENTION

Configuration backup files are specific to the Traffic Manager on which they are created, and as such are not part of the configuration automatically replicated between Traffic Managers in a cluster. If you terminate or delete a particular cluster member, any configuration backups stored on it are lost.

Making a Backup

Use the "Create a Backup" form to make a backup of your configuration. This backup is stored on the local Traffic Manager machine.

If the Web Application Firewall is licensed and enabled in your Traffic Manager deployment, you can optionally include the Application Firewall configuration in your backup by ticking the **App Firewall** box.

Restoring a Backup

Click a backup name from the table on the Backup Management page. Use the **Restore Configuration** option to replace the current configuration with the contents of the configuration backup.

A configuration backup will contain machine-specific information from the Traffic Manager it was taken from, such as Traffic IP Groups. Therefore, at this point you must decide whether or not to replace the current Traffic Manager's local machine configuration. You have two options:

- Use the machine-specific configuration from the backup

If you are restoring a backup made from the same Traffic Manager, you will simply overwrite the local configuration with the backed-up configuration. Should you have made this backup on a different Traffic Manager, you will be presented with a mapping control. Here you can decide on the mapping for the machine configuration stored in the backup:

This backup contains machine specific information, such as networking configuration and Traffic IP groups. Do you want to:

Restore backup with machine specific information according to the following mapping...

| Original Traffic Manager | → | New Traffic Manager |
|--------------------------|---|--------------------------------------|
| dev-vm08-0 | → | dev-vm08-2 |
| dev-vm08-4 | → | Do not restore this machine's config |

Restore backup without any machine specific information.

In this example, the backup contains configuration for a cluster of two Traffic Managers. Using this tool, you can decide which Traffic Manager is used for the restored configuration and which is ignored. Note that you can only create a one-to-one mapping between machine configurations.

- Restore the backup without any machine specific information.

The machine-specific configuration stored in the backup is ignored, and the current Traffic Manager local machine configuration retained.

If the Web Application Firewall is licensed and enabled in your Traffic Manager deployment, you can optionally choose to also restore the Web Application Firewall configuration from your backup, if one exists, by clicking Include Application Firewall configuration.

Exporting a Backup

Configuration backups are stored on the local Traffic Manager machine. You can export a configuration backup for safekeeping.

Click a backup name from the table on the Backup Management page. Use the **Export Configuration** option to download the configuration backup to your local machine.

ATTENTION

Store this backup securely. It contains sensitive information, including SSL certificates.

Exporting a Backup as a Configuration Document

The Traffic Manager includes a tool called the Configuration Importer, used to import a complete system configuration into a Traffic Manager instance from a previously-created definition - typically within an orchestration tool such as Docker or Kubernetes. Such definitions are contained within text files called *configuration documents* and the Configuration Importer uses these documents to construct the definitions on the local Traffic Manager, replacing its previous running configuration.

Click a backup name from the table on the Backup Management page and use the "Export Configuration document" section to create and export a configuration document based on the configuration contained within the backup.



To create a configuration document based instead on the current running configuration, use the **Services > Configuration Summary** page.

For a complete description of this functionality, see the *Pulse Secure Virtual Traffic Manager: Configuration Importer Guide*.

Importing a Backup

You can import a previously exported configuration backup. Use the "Import a Backup" section to upload a configuration backup from your local machine.

When you import a backup, it is added to the list of configuration backups on the Traffic Manager machine. It does not replace the current configuration. You can then restore the backup you have just uploaded to replace the current configuration if desired.

System > Backups > Partial Backups

This section provides the same backup/restore functionality of a full backup, yet allows you to tailor the contents of the backup to contain only a subset of a full configuration. It can be accessed from the link on the **System > Backups** page.



Partial backups are not transferable between Traffic Manager software versions. In other words, a partial backup you create in one version of the Traffic Manager cannot be imported into any other version.

This feature provides similar functionality to the “zconf” command-line utility described in [Granular Configuration Import/Export with zconf](#), and can be useful when trying to copy specific services to other Traffic Manager clusters. Unlike a regular import, the configuration being imported is merged with the existing one instead of replacing it.

The page is separated into two main sections, one to handle the import and merge process, and another to enable exporting of partial backups.

Importing

This section of the page allows you to import a partial or full backup. To facilitate a partial import from the uploaded backup file, you can provide a suitable filter in the **Include Only** text box provided. The system will import any objects that match this filter, along with any objects upon which the selected objects depend. For example, the pools used by a selected virtual server will also be imported. For more details about the format used, see [Filter Formats](#).

After uploading a backup file, and optionally specifying a filter, you will be presented with a “Diff” (a list of differences) showing the changes that will be made to the system. You should review the Diff and satisfy yourself that everything is correct. Click **Apply Partial Backup** to commit the changes.

ATTENTION

Importing partial backups can lead to an inconsistent configuration if not handled correctly. Always review the Diffs presented when importing a partial backup. As with all backup and restore operations, it is strongly recommended that you create a full backup point before applying a partial backup.

Exporting

This section is used to download partial or full configuration backups. To facilitate a partial backup, you can set a suitable filter in the **Include Only** text box provided. The system will then export only the configuration objects that match this filter, along with their dependencies. For more details about the format used, see [Filter Formats](#).

Filter Formats

The **Include Only** filter is a space separated list of entries according to one of the following formats:

[CONFIGURATION TYPE] For example: vservers

or

[CONFIGURATION TYPE] / [NAME] For example: vservers/Intranet

or

[CONFIGURATION FILE]

For example: users



When a configuration name has one or more spaces in it, you should precede each space character with a forward slash (\). This will ensure that the space is treated as part of the name and not a separator. For example, Intranet Master Service would be entered as Intranet\ Master\ Service.

The filter allows the use of an asterisk (*) as a wildcard to represent zero or more characters. For example, typing "net*" matches "net", "net.cfg", and "network".



You can include the special configuration file "settings.cfg" to back up your global settings (**System > Global Settings**), and the configuration file users to back up your local user settings (**System > Users**).

For example, to import all virtual servers, the monitor "Primary Database Monitor" and your global settings, enter the following filter:

The following table lists the configuration identifiers you can choose to include:

| Identifier | Description |
|--------------------|---|
| actionprogs | Action Programs |
| actions | Alerting Actions |
| activitymonitor | Current Activity Graphing Data Settings |
| appliance | Appliance Management |
| optimizer/profiles | Web Accelerator Profiles |
| optimizer/scopes | Web Accelerator Scopes |

| Identifier | Description |
|---------------------------|---|
| auth | Admin Interface / Admin Server Authenticators |
| authenticators | TrafficScript Remote Authenticators |
| ApplicationFirewallConfig | Web Application Firewall Configuration |
| auth | Authenticators |
| bandwidth | Bandwidth Classes |
| cloudcredentials | Cloud Credentials |
| custom | Custom Configuration Sets |
| dnsserver/zonefiles | DNS Server Zone Files |
| dnsserver/zones | DNS Server Zones |
| events | Alerting Event Types |
| extra | Miscellaneous Files |
| flipper | Traffic IP Groups |
| groups | User Groups |
| jars | TrafficScript Java Extensions |
| licensekeys | License Keys |
| locations | Multi Site Management and Global Load Balancing Geographic Locations |
| monitors | Monitors |
| persistence | Session Persistence Classes |
| pools | Pools |
| protection | Service Protection Classes |
| rate | Rate Shaping Classes |
| rules | TrafficScript Rules |
| scripts | Monitor Scripts |

| Identifier | Description |
|--------------------------------|--------------------------------------|
| <code>services</code> | Global Load Balancing (GLB) Services |
| <code>servlets</code> | Java Extension Servlets |
| <code>slm</code> | Service Level Monitoring Classes |
| <code>ssl/cas</code> | SSL Certificate Authorities |
| <code>ssl/client_keys</code> | SSL Client Certificates/Keys |
| <code>ssl/dnssec_keys</code> | DNSSEC Keys |
| <code>ssl/server_keys</code> | SSL Server Certificates/Keys |
| <code>supplementarykeys</code> | Supplementary License Keys |
| <code>vservers</code> | Virtual Servers |
| <code>zxtms</code> | Traffic Managers |

Including the Web Application Firewall in a Partial Backup

To include the Web Application Firewall (WAF) in a partial backup, you must also include the Global Settings file. In addition, WAF must be enabled in your Traffic Manager configuration before you create the backup.

In other words, with WAF enabled, add the following to the **Include Only** filter in the “Export” section:

- `settings.cfg`
- `ApplicationFirewallConfig`

Equally, to import WAF configuration through the Partial Backups page, ensure you add both files to the **Include Only** filter in the “Import” section.

ATTENTION

Restoring the “settings.cfg” file to your active Traffic Manager configuration in this way overrides all Global Settings configuration, not just WAF-specific key values. Ivanti recommends creating a backup of this file before restoring a copy of it through a partial backup.

Activity Monitoring

Several visual traffic monitoring tools allow you to keep track of the current and past activity on your system. To access these tools, click the **Activity** button on the top bar of the Admin UI.

Activity > Current Activity

The “Current Activity” page shows you a real-time graph of the traffic activity on your system. You can customize the data extensively.

You can choose some standard sets of data to plot, traffic values such as current bandwidth, number of connections the Traffic Manager processes or hardware values such as free memory or spare CPU time. Much of this information can be split by virtual server, by pool, or by node. You can also dictate the size of the graph, the timescale, and choose between linear and logarithmic axes, or a pie chart. You can graph across all the machines or one at a time.

When you have chosen your settings, click **Plot Data** to view the graph. You can also download the data as a .tsv (tab-separated variable) file for your own analysis.

To further customize the data on the graph, click the **Change Data** button. This takes you to the **Current Activity > Edit** page where you can specify the data to plot.

In the “Global Values” section you can choose statistics to monitor and plot for the system as a whole. The “Virtual Server Values”, “Pool Values” and “Node Values” sections allow you to plot data split into individual instances of these. You can view data transfer and connection counts as well as DNS and SNMP request data, content compression and HTTP rewrites.

The “Service Protection Class Values” section allows you to plot information about requests rejected by service protection classes. You can view data for all or a subset of your service protection classes, and split the data by the reason for rejection, such as the connection count from a single IP address being too high or the request containing disallowed content.

When you have chosen the settings to plot, you can save them to use again later. When you have finished, click **Apply**.

Monitoring Performance Using SNMP

Simple Network Management Protocol (SNMP) is an open standard for network monitoring and management. It can allow you to monitor devices on a network and gather performance data.

The Traffic Manager supports multiple SNMP versions: v1,v2c and v3.

The Traffic Manager allows you to monitor performance using an SNMP tool such as HP OpenView™. You can extract information about the traffic flow for your own analysis.



The Traffic Manager is also capable of sending asynchronous SNMP notifications, known as SNMP Traps. For more details, see [Event Handling and Alerts](#).

To configure SNMP, click **System > SNMP**. Here you can download the relevant Traffic Manager MIB (Management Information Base) for your chosen SNMP version. The MIB is a database of the information used by SNMP, and comes in two SMI (Structure of Managed Information) versions:

- **SMIv1**: for SNMPv1 clients only
- **SMIv2**: for SNMPv2c and v3 clients only

Either click the link to view the MIB in your browser, or right-click to save the contents to a file on your computer.

Common SNMP Settings

To enable SNMP, set **snmp!enabled** to “Yes” and click **Update**.

You can configure common settings such as the port and bind IP address the SNMP service should listen on, and the clients that should be allowed to access the service.

The standard port for SNMP is 161, but if you wish to use an unprivileged port then 1161 is a good alternative.

SNMPv1 and SNMPv2c Settings

You can configure the following settings:

| Setting | Description |
|----------------|---|
| snmp!community | In order to function correctly, the SNMP server must have a suitable community string. This is the equivalent of a password, and identifies authorized SNMP requests. It is not secure, as it is transmitted in the SNMP request as plain text, so you should not use a sensitive secret as the community string. The default value for many SNMP clients is “public”. Since the Traffic Manager can restrict access to the SNMP service, the strength of this secret is not a major concern. |

| Setting | Description |
|---------|---|
| | Leaving the community string blank/empty will cause all SNMPv1 and SNMPv2c commands to be rejected. |

SNMPv3 Settings

This section allows you to specify the authentication and privacy settings for accepting and responding to SNMPv3 commands.



One ingredient involved in the generation of cryptographic keys from passwords is the so-called "Engine ID". The Traffic Manager generates this value using a combination of the Zeus¹ enterprise OID (7146) and the first MAC address on the machine it is running on. The correct Engine ID value for the Traffic Manager you are connected to is displayed in this section.

All SNMPv3 communication is checked against the user settings that follow, and commands whose security parameters do not exactly match are rejected. (However, snmpEngineID discovery messages, which are never authenticated and which may be sent with an empty username, are permitted and responded to).

You can configure the following settings:

| Setting | Description |
|---------------------|--|
| snmp!username | <p>This is the SNMPv3 user's username, required for all SNMPv3 commands and communication. If you set this to blank/empty, all SNMPv3 commands will be rejected.</p> <p>The Traffic Manager requires and permits a single SNMPv3 user account to be defined. Authentication and privacy settings for this user are defined according to the fields that follow, and are based on the "User-based Security Model" described in RFC3414 (http://www.ietf.org/rfc/rfc3414.txt).</p> |
| snmp!security_level | The SNMPv3 user's choice of whether to use authentication, and whether to use privacy. SNMPv3 commands must obey this choice, or they are rejected. SNMPv3 responses obey this choice. |

¹Zeus is the name of the product upon which the Traffic Manager was originally based.

| Setting | Description |
|--------------------|---|
| | <p>Selecting Authentication here means that commands and responses are cryptographically signed with a key derived from <code>snmp!auth_password</code>, and this signature is included in the message. Incorrectly signed commands or responses are detected and rejected. This is intended to prevent an imposter masquerading as a trusted party, as long as the password remains secret.</p> <p>Additionally selecting Privacy here means that parts of commands and responses are encrypted using DES with a key derived from the <code>snmp!priv_password</code>. This is intended to prevent an eavesdropper from reading the content of messages, as long as the password remains secret.</p> |
| snmp!hash_alg | <p>This is the SNMPv3 user's choice of cryptographic hash algorithm, required for SNMPv3 commands and used for responses.</p> <p>Supported hash algorithms are MD5 and SHA-1. See RFC 3414 for details (http://www.ietf.org/rfc/rfc3414.txt).</p> <p>If you set snmp!security_level to "No Authentication, No Privacy", this setting is not used.</p> |
| snmp!auth_password | <p>The SNMPv3 user's password for authentication.</p> <p>This is a shared secret; you should configure your SNMP client user account with the same authentication password.</p> <p>The authentication key for SNMPv3 communication is derived from this password.</p> <p>If you set snmp!security_level to "No Authentication, No Privacy", this setting is not used.</p> |
| snmp!priv_password | <p>The SNMPv3 user's password for privacy (message encryption).</p> <p>This is a shared secret; you should configure your SNMP client user account with the same privacy password.</p> |

| Setting | Description |
|---------|--|
| | <p>The privacy key for SNMPv3 communication is derived from this password. Re-using your authentication password here is not recommended for security reasons.</p> <p>If you set snmp!security_level to "No Authentication, No Privacy", or "Authentication only", this password is not used.</p> |

Custom Performance and Event Monitoring

The `counter.increment()` TrafficScript function is used to increment one of 10 built-in counters.

You can retrieve the values of these counters using SNMP, and you can graph them in the **Activity Monitor**.

These counters can be used to record custom events that you detect using TrafficScript. For example:

- If you perform authentication in a TrafficScript rule, you could count the number of authentication failures.
- If a particular class of request is particularly resource heavy, you could chart the number of times that request is made.
- If you perform security checking, for example, for a known Web worm signature, you could count and chart the number of times the signature was found.

You can increase the number of built-in SNMP counters by changing the **snmp_user_counters** value located in **System > Global Settings > Other Settings**.

Activity > Historical Activity

By default, the Traffic Manager records system activity for the past 90 days. To change the number of days for which data is stored, click **System > Global Settings > Other Settings** and modify the number stored in **statd!days**. A value of 0 instructs the Traffic Manager to keep data indefinitely.

To view historical system activity, click **Activity > Historical Activity**.

Select a graph of hits per minute or bits processed per second, displayed by virtual server, pool, or node. The Traffic Manager offers a range of timescales for the data you want to plot from 1 hour up to 1 year, although the options available are affected by the value set in **statd!days**.

Choose to plot data for all virtual servers, pools, or nodes in the system, or for a selected subset. Choose also the chart size and axis type.

Click **Plot Data** to view the graph using the current setting. You can also download the data as a ".tsv" (tab-separated variable) file for your own analysis.

Activity > Map

The map provides a view of the geographic origin of requests being handled by your traffic management system.

The map is designed to be interactive and tools are provided to move around and zoom into a level of detail required for your infrastructure. You can center the map on a geographic location of your choice by holding down the left-hand mouse button and dragging the map to your required destination.

Each small dot that appears on the map represents a user who has issued a request for a particular service.



To enable the map to show activity corresponding to user locations, the Traffic Manager requires access to a GeolIP database. For more information, see [Using a GeolIP Database](#).

Activity > Connections



This functionality described in this section is individually license-controlled. Some licenses provide a Basic functionality mode only, with simple connection information, fewer customization options and a single filter. A Full mode that supports all the features described here is available under the "advanced real-time analytics" license option. Contact your support provider if you wish to purchase this option.

Basic Mode

The **Connections** page gives you the ability to monitor current and recent connections being handled by the Traffic Manager, in date order (most recent first). This is a snapshot of connections from a point in time, where all connections after that time will not be displayed until the **Refresh Snapshot** button is pressed.

You can show and hide field columns using the **[+]** button in the top left of the connections table. This displays a drop-down list of fields that the table is currently displaying. Clicking on each field in this list toggles it between being displayed or hidden.

A simple filter can be applied to the displayed data to show connections only to a specific node (the "To" column). This is a single-field version of the filter functionality available in the Full mode. Refer to the usage instructions described next.

Full Mode

In this mode all of the above features are present, with additional connection detail and customization now available. You can apply a sort to the displayed data by clicking on the column heading you wish to sort by. A small arrow next to the sorted column indicates the direction of sort. You can toggle this between ascending and descending by clicking on it.

In addition to the node filter, you can now filter the connections by any field or data in the table. This can be achieved via the drop-down box in the filter section at the top of the page, or by clicking directly on one of the data values in the table. This second method produces an in-line "add filter" dialog that allows you to filter away all connections that do not share the value of the selected field.

For example, suppose you want to see requests that originate from a specific IP address and port that result in an HTTP response code of 200. First click the IP address you wish to use in the "From" column. A filter popup will appear, populated with the selected IP:

| | Traffic Manager | From | To | VS | Pool | Resp. Code | Request |
|--|--------------------|-------------------|------------------|----------|---------|------------|--|
| | coeus.cam.zeus.com | 10.100.1.14:37077 | 92.52.65.222:80 | website | website | 200 | /favicon.ico |
| | coeus.cam.zeus.com | 10.100.1.14:37074 | 92.52.65.213:80 | website | website | 200 | /assets/img/bullet.gif |
| | coeus.cam.zeus.com | 10.100.1.14:37076 | 92.52.65.222:80 | website | website | 200 | /assets/default/Site/en/images/tri/triboo.gif |
| | coeus.cam.zeus.com | 10.100.1.14:37072 | 92.52.65.222:80 | website | website | 200 | /assets/default/Site/en/images/gil/glit.gif |
| | coeus.cam.zeus.com | 10.100.1.14:37074 | 92.52.65.213:80 | website | website | 200 | /assets/default/Site/en/images/dom/dominos.gif |
| | coeus.cam.zeus.com | 10.100.1.14:37072 | 92.52.65.222:80 | website | website | 200 | /assets/default/Site/en/images/vir/virgin.gif |
| | coeus.cam.zeus.com | 10.100.1.18:3636 | 212.58.246.93:80 | intranet | test | 301 | / |
| | coeus.cam.zeus.com | 10.100.1.18:3620 | 212.58.246.93:80 | intranet | test | 301 | / |
| | coeus.cam.zeus.com | 10.100.1.18:3499 | 212.58.246.92:80 | test | test | 301 | / |
| | coeus.cam.zeus.com | 10.100.1.18:3438 | 212.58.246.92:80 | test | test | 301 | / |

Click the **Filter** button to apply the described logic. This filter is added to the "Active Filters" display at the top of the page. Now click the value "200" in the "Resp. Code" column and apply a filter to this. You should now see only the desired connections.

| | Traffic Manager | From | To | VS | Pool | Resp. Code | Request |
|---|--------------------|-------------------|-----------------|---------|---------|------------|---|
| ⌵ | coeus.cam.zeus.com | 10.100.1.14:37074 | 92.52.65.213:80 | website | website | 200 | /assets/img/bullet.gif |
| ⌵ | coeus.cam.zeus.com | 10.100.1.14:37074 | 92.52.65.213:80 | website | website | 200 | /assets/default/Site/en/images/vir/virgin.gif |
| ⌵ | coeus.cam.zeus.com | 10.100.1.14:37074 | 92.52.65.213:80 | website | website | 200 | /assets/img/divider.gif |
| ⌵ | coeus.cam.zeus.com | 10.100.1.14:37074 | 92.52.65.222:80 | website | website | 200 | /assets/img/logo.gif |
| ⌵ | coeus.cam.zeus.com | 10.100.1.14:37074 | 92.52.65.213:80 | website | website | 200 | /assets/default/Site/en/css/main.css |

Adjustments can be made to the active filters by making a change and then clicking the **Update Filters** button to redisplay the connection data. To remove a filter, tick the checkbox next to the criteria that you want to remove, and click **Update Filters**. All filters can be removed by clicking **Clear Filters**.

The **Refresh** button can be used to update the results snapshot, and the **Download** button provides a .tsv (tab separated value) file of the results for analysis in other applications.

Furthermore, clicking on the magnifying glass icon to the left of each line provides additional details for a specific connection:

| Section | Description |
|------------------|--|
| Request tracing | <p>This section gives you a timeline of internal connection processing events. This can show you how long the entire request took, how much of that time was spent processing TrafficScript rules, and other useful information.</p> <p>This information will be recorded only if the request_tracing!enabled key is enabled for the virtual server that processed the connection. For further information, see Connection Analytics.</p> |
| Request details | This section shows you all of the request headers that the request contained. |
| Response details | This section shows you all of the response headers (including those that may have been added by TrafficScript or verbose cache logging). |



You can increase the size of the Connections snapshot using the **System > Global Settings** page; look in the "Logging" section for the **recent_conns** key.

Activity > Draining Nodes

If you want to remove a node from the system, for instance for maintenance or upgrade, you can set it to “drain”. The node will continue to handle any existing sessions, but the Traffic Manager will not send it any more connections. The “Draining Nodes” section shows information about any nodes you are currently draining.

For each draining node, the page shows the time since the last connection, and the current number of active connections. You can update the information by clicking **Reload This Page**.

When all the active sessions have expired, it is safe to remove the node; you can do this via the **Pools > Edit** page or use the **Remove a Node** wizard.

For further information, please refer to the description of node draining in the [Draining, Disabling, or Removing a Node](#).

Activity > View Logs

Virtual servers may be configured to log all transactions to a Request Log. In the **Virtual Server > Request Logging** page (see [Request Logging](#)), you may configure what information is logged, and where the log files are written to.

The **Activity > View Logs** page allows you to watch the request logs in real-time as records are appended to them.



Traffic Manager virtual and cloud instances are self-contained and have a dedicated, self-managed log partition. Log files are stored in this partition, archived and deleted automatically. You do not need to configure the location where request log files are stored.



Log files can be viewed using the **Activity > View Logs** page, and can be downloaded using the **Activity > Download Logs** page. You can also use the Traffic Manager “Control API” to download and manage log files on Traffic Manager virtual/cloud instances.

Exporting Analytics to a Remote Service

Your Traffic Manager cluster can export metadata for transactions handled by your virtual servers, and stored log data, to an external source for offline analysis.

Transaction metadata is information about individual transactions processed by the Traffic Manager, such as an HTTP request or the communication between a client and server over a generic TCP connection.

This information can provide detailed visibility into the health and efficiency of the services running on your cluster, or to facilitate debugging in the event of unexpected service behavior.

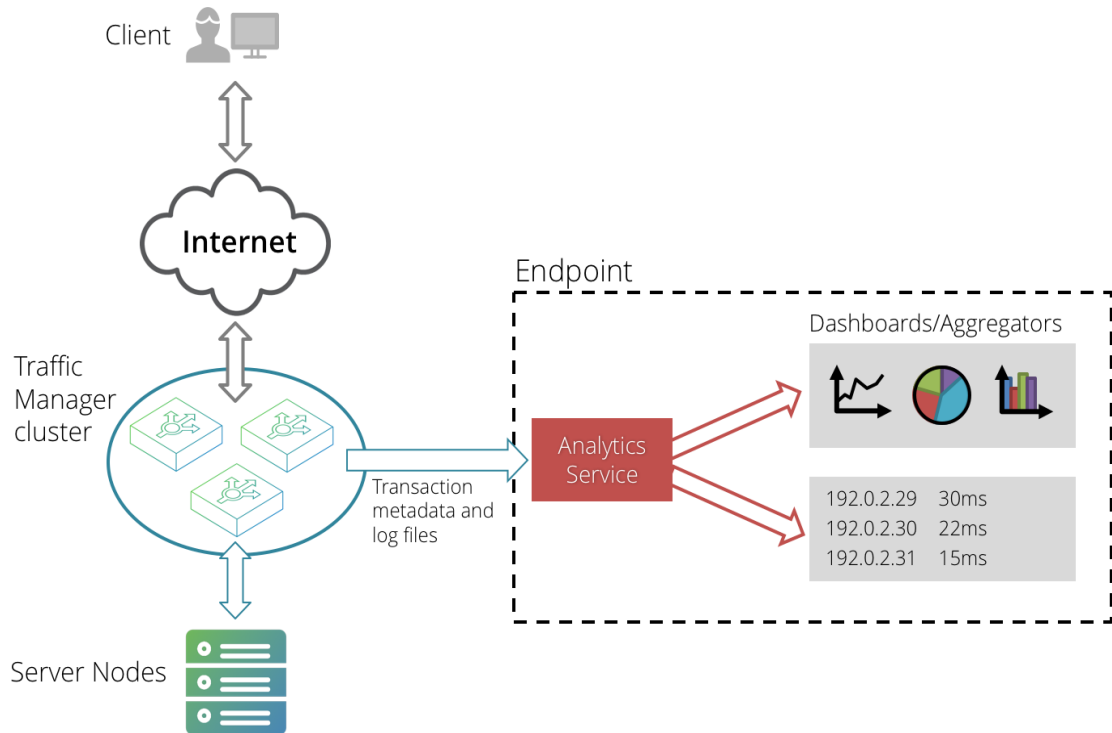

The Traffic Manager allows you to remotely stream the following data types:

- Metadata for all transactions handled by a virtual server and recorded on the **Activity > Connections** page.
- A configurable set of log files stored on the Traffic Manager cluster.
- SNMP counters



SNMP counters are available to any SNMP-ready service as a standard method of monitoring the activity of your Traffic Manager, and not strictly a configurable part of the analytics export capability. For more information on SNMP, see [Activity Monitoring](#).

To receive the analytics data exported from a Traffic Manager, your endpoint should employ an analytics service that supports ingestion of data in JSON format through TCP streams (for transaction metadata) and POST requests (for log data). You configure the Traffic Manager with the IP address and port on which the analytics service is listening, and the URL to which exported log data is sent.

To configure transaction analytics and log data export settings, click **System > Analytics Export**.

For settings that control exporting transaction metadata, use the "Transaction Metadata" section. For settings that control exporting log data, use the "Log Files" section.



Analytics Export settings are shared with every Traffic Manager in the same cluster. Consequently, any changes you make to one cluster member are automatically replicated out to all other members.

Configuring Export Settings for Transaction Metadata Records

The Traffic Manager maintains a series of long-lived TCP connections to the endpoint, with each connection managed by an internal data-plane process. The data-plane processes handle incoming transactions with the Traffic Manager and stream corresponding metadata records in JSON format, separated by newline characters, to the endpoint.

If a connection to the endpoint fails for any reason, all unsent metadata records are typically dropped. The Traffic Manager maintains an SNMP counter to track the number of records that it was unable to export.

Use the Transaction Metadata settings to configure how the Traffic Manager exports transaction metadata records to the defined endpoint.

Transaction Metadata

These settings control how metadata about transactions processed by the traffic manager is exported.

[View JSON Schema for transaction metadata](#)

Export metadata about transactions processed by the traffic manager to an external location.

transaction_export!enabled: Yes No Default: No

The endpoint to which transaction metadata should be exported. The endpoint is specified as a hostname or IP address with a port.

transaction_export!endpoint:

Whether the connection to the specified endpoint should be encrypted.

transaction_export!tls: Yes No Default: Yes

Whether the server certificate presented by the endpoint should be verified, preventing a connection from being established if the certificate does not match the server name, is self-signed, is expired, is revoked, or has an unknown CA.

transaction_export!tls_verify: Yes No Default: Yes

To view the JSON schema the Traffic Manager uses when streaming transaction metadata, click **View JSON Schema for transaction metadata**. Use this schema to configure your analytics service with the structure of metadata records it should expect.

The Transaction Metadata section contains the following configuration keys:

| Key | Description |
|-----------------------------|---|
| transaction_export!enabled | <p>Enables the cluster-wide connection to the external endpoint configured in transaction_export!endpoint.</p> <p>If enabled, the Traffic Manager exports metadata for all transactions handled by virtual servers on which the equivalent setting is enabled. If disabled, the Traffic Manager exports no transaction metadata regardless of individual virtual server settings.</p> <p>To view and modify individual virtual server export settings, see Exporting Transaction Metadata.</p> |
| transaction_export!endpoint | <p>The endpoint to which the Traffic Manager sends analytics data.</p> <p>Use the format <hostname>:<port> where <hostname> is a hostname or IPv4/IPv6 address, and <port> is a port number. Literal IPv6 addresses must be enclosed in square brackets. For example, "[fe80::1]:5000". If you specify a hostname, the Traffic Manager uses this as the Server Name Indication in the TLS handshake.</p> |

| Key | Description |
|-------------------------------|---|
| | The endpoint must be configured to receive JSON events through a TCP socket. It is not an HTTP endpoint. |
| transaction_export!tls | <p>Enables TLS encryption for the connection to the endpoint.</p> <p>If enabled, the settings contained in System > Global Settings > SSL Configuration are applicable to the connection.</p> <p>Transaction metadata records might contain confidential or user identifying information, depending on the application. To maintain confidentiality on production systems, make sure the connection to the analytics service is encrypted and verified (see also transaction_export!tls_verify). Ivanti strongly recommends disabling TLS encryption only for testing in a development environment.</p> |
| transaction_export!tls_verify | <p>Enables verification of the endpoint's TLS server certificate against Certificate Authority (CA) certificates present in the Traffic Manager's "Certificate Authorities and Certificate Revocation Lists" catalog.</p> <p>This setting ensures the Traffic Manager disallows server certificates that do not match the server name, are self-signed, expired, revoked, or have an unknown CA.</p> |

For additional per-service configuration, use the Connection Analytics section on the desired virtual server **Edit** page. Use these settings to disable or limit analytics exporting for specific virtual servers, and thus to limit the overall volume of data exported by the Traffic Manager. For more information, see [Exporting Transaction Metadata](#).

Configuring Export Settings for Log Files

Use the Log Files section to configure how the Traffic Manager exports log data to the defined endpoint.

▼ Log Files

These settings control which log files should be exported, and how entries from those log files should be exported.

Monitor log files and export entries to the configured endpoint.

log_export!enabled: Yes No Default: No

The URL to which log entries should be sent. Entries are sent using HTTP(S) POST requests.

log_export!endpoint:

Log file categories currently configured to be exported

| | |
|------------------------------------|---|
| Admin Server Access | ⊗ |
| Application Firewall | ✓ |
| Audit Log | ✓ |
| Event Log | ✓ |
| Process Monitor | ⊗ |
| Routing Software | ⊗ |
| System - authentication log | ⊗ |
| System - syslog | ⊗ |

 **Choose Log Files to export**

The HTTP authentication method to use when exporting log entries.

None

Basic (Username and Password) ...

The username to use for HTTP basic authentication.
log_export!auth!username:

The password to use for HTTP basic authentication.
log_export!auth!password:

Splunk (HEC token) ...

The HTTP Event Collector token to use for HTTP authentication with a Splunk server.
log_export!auth!hec_token:

Whether the server certificate should be verified when connecting to the endpoint. If enabled, server certificates that do not match the server name, are self-signed, have expired, have been revoked, or that are signed by an unknown CA will be rejected.

log_export!tls_verify: Yes No Default: Yes

The number of seconds after which HTTP requests sent to the configured endpoint will be considered to have failed if no response is received. A value of 0 means that HTTP requests will not time out.

log_export!request_timeout: seconds Default: 30

The Traffic Manager provides a summary list of log file categories currently included or excluded from the export set. To configure the list of log file categories, click **Choose Log Files to export**.

The Log Files section contains the following configuration keys:

| Key | Description |
|-----------------------|---|
| log_export!enabled | <p>Enables the connection to the configured endpoint for log file exporting.</p> <p>If enabled, log data is sent over HTTP connections to the endpoint URL contained in log_export!endpoint.</p> <p>Before you enable log file exporting, review the list of log file categories to be exported from the Traffic Manager. For more information, see Selecting Log File Categories to Export.</p> |
| log_export!endpoint | <p>The URL of the endpoint to which the Traffic Manager sends log data.</p> <p>The endpoint must be an http or https based URL configured to receive HTTP post requests containing one or more JSON encoded events.</p> |
| log_export!auth!http | <p>The type of HTTP authentication the Traffic Manager should use with its connection to the endpoint.</p> <p>Choose one of the following methods:</p> <p>"None": Use no authentication method.</p> <p>"Basic": Use HTTP basic authentication. Specify the required credentials in log_export!auth!username and log_export!auth!password.</p> <p>"Splunk": Use an HEC token for HTTP authentication with a Splunk® server. Specify your token in log_export!auth!hec_token.</p> |
| log_export!tls_verify | <p>Enables verification of the configured endpoint's TLS server certificate against Certificate Authority (CA) certificates present in the Traffic Manager's "Certificate Authorities and Certificate Revocation Lists" catalog.</p> <p>This setting ensures the Traffic Manager disallows server certificates that do not match the server name, are self-signed, expired, revoked, or have an unknown CA.</p> |

| Key | Description |
|----------------------------|--|
| log_export!request_timeout | <p>The time limit, in seconds, after which the Traffic Manager considers the connection to have failed.</p> <p>Use this setting to specify a time limit for the Traffic Manager to process each POST request. This can be useful to detect a malfunction in the analytics service operating at the endpoint.</p> <p>To specify no limit, use a value of 0.</p> |

Selecting Log File Categories to Export

Use the Log File Export Categories page to include, exclude, or modify the categories of logs contained on your Traffic Manager as part of the export set.

A log file category corresponds to a set of related log files stored on the Traffic Manager system. As standard, the Traffic Manager provides several built-in log categories applicable to all product variants.

Log File Export

Log File Export Categories
Unfold All / Fold All

A log file export category manages a set of related log files that can be exported by the traffic manager. Some categories of log file are exported only on appliance platforms.

- ▶ **Admin Server Access (Built-in)**
 Edit

The Administration Server access log.
- ▶ **Application Firewall (Built-in)**
 Edit

Log files from all application firewall processes.
- ▶ **Audit Log (Built-in)**
 Edit

The traffic manager audit log.
- ▶ **Event Log (Built-in)**
 Edit

The traffic manager event log.
- ▶ **Process Monitor (Built-in)**
 Edit

Log files maintained by the traffic manager's internal health monitor.
- ▶ **Routing Software (Built-in, Appliance)**
 Edit

Log files generated by the traffic manager's OSPF and BGP routing software.
- ▶ **System - authentication log (Built-in, Appliance)**
 Edit

The operating system's authentication log.
- ▶ **System - syslog (Built-in, Appliance)**
 Edit

The operating system's syslog.

Create new log file export category

Name:

Each item in the list marked "Built-in" represents a standard Traffic Manager log export category. The tick icon refers to those logs marked to be included in the export set. The cross icon indicates a log that is currently excluded.

A tag of "Appliance" after the log name indicates a log category that is exported only for Traffic Manager appliance variants.

To export additional log categories, perhaps belonging to other processes running on the same system as the Traffic Manager, add a new log type in the "Create new log file export category" section. Then, configure the log location on the Log Export Category edit page.

Editing Log Export Categories

To include or exclude a log category from the export, or to set other configurable details, click **Edit** alongside the log name to edit the log export category properties.

The edit page contains the following configuration keys:

| Key | Description |
|----------------|--|
| enabled | Includes this log category in the export set. |
| appliance_only | Export this log category only for Traffic Manager appliance variants. |
| files | The set of glob patterns to select the log file and any rotated (historic) versions the Traffic Manager should include in the export set. |
| note | A free text description for this log category. |
| history | How much historic activity for this log should the Traffic Manger export. Use one of the following values: "Do not export any historic entries" : Ignore all historic activity logs and use only current activity logs in the export. "Export all historic entries" : Include all current and historic activity logs in the export. "Export recent historic entries, according to the history_period setting" : Include historic activity up to the number days set in history_period . |

Configuring Metadata Tags for Log Records

Use the Metadata section to define a set of machine-readable name/value pairs to be appended to the records sent to the endpoint for this log category.

Edit your metadata tags to suit the requirements of the remote analytics service. To ensure the output of each log category is individually identifiable, make sure each log category has a unique set of metadata tags defined. Otherwise, the analytics service cannot determine which records belong to which group of log files. Refer to the documentation for your analytics service to determine which record tags might be needed.

The Traffic Manager supports nested metadata tags to implement grouping of related data objects. To nest your tags, use a period (.) as the separator, as in the form "<first part>.<second part>.<third part>.<etc.>". For example, "fields.format".

The Traffic Manager additionally supports two special macros which, when specified in your metadata tag values, are replaced in the log records with the corresponding identifier:

- **%cluster_id%**: the identifier for your Traffic Manager cluster.
- **%instance_id%**: the identifier for the Traffic Manager instance that recorded the log entry.

Built-in log categories include a number of predefined metadata tags by default. These tags are optional and can be removed by selecting the **Remove** checkbox adjacent to each tag. Click **Update** to complete the action.

The predefined tags are:

- **source**: a text name that describes the source of the log, used to facilitate searching for records in the analytics service. For example, "eventlog" identifies entries exported from the Traffic Manager's Event Log.
- **sourcetype**: a text definition of the log format, used by the analytics service to guide parsing and extraction of fields. For example, "zxtm_event_log" indicates that the information contained in the main "event" parameter of the exported records is in the format of the Traffic Manager's Event Log.

Cloud Credentials

When using Traffic Manager software in a cloud environment, the Traffic Manager might require authentication credentials in order to make API calls to the cloud provider. Primarily, pools set to use autoscaling will require API credentials to enable the scaling mechanism within the cloud. This section allows you to record such credentials in a catalog object, based on the requirements of the chosen cloud provider API. For more details about pool autoscaling, see [Autoscaling](#).

The Traffic Manager provides a number of built-in cloud API's upon which to base your credential set:

- VMware vSphere
- Amazon EC2
- Rackspace Cloud

Additional custom cloud APIs can be added by uploading appropriate executable scripts through the **Catalogs > Extra Files** facility. Refer to the Traffic Manager section of the Pulse Community website (<https://community.pulsesecure.net>) for further details.

To create a new set of cloud credentials:

1. Click **Catalogs > Cloud Credentials**.
2. Enter a name in the **Name** field.
3. Select the **Cloud API** you wish to use.
4. The remaining fields differ depending on the API chosen. They typically include an ID, password/passcode, and additional authentication information.
5. Click **Create Cloud Credentials**.

The table below provides details for each of the fields presented when you create a new set of credentials:

| Setting | Description |
|-----------------------------|---|
| Name | The name used to identify this set of credentials within the Traffic Manager's configuration. |
| Cloud API | The selected cloud provider API. |
| ID / Name (cred1) | The username or ID of the cloud provider account to be used for API calls. |
| Auth Key / Password (cred2) | The password associated with the username/ID. |
| Token / Server (cred3) | Some cloud providers also require an authentication token or additional item in order to make API calls. VMware vSphere requires a vCenter hostname/IP to accept API calls. This extra information can be specified here. |
| update_interval | The Traffic Manager periodically queries the cloud provider for the status of all instances running on behalf of the user. This is necessary in order to be up-to-date when nodes are added or removed by external systems. The update_interval determines how often (in seconds) these status calls are made. Note that some clouds impose a limit on the number of such calls that can be made per minute. |
| change_process_timeout | The maximum amount of time (in seconds) a change process can take. For example, when a request is made to the cloud API for node creation/destruction, this setting specifies how long to wait for the request to complete. |

IAM Roles in Amazon EC2 Credentials

Amazon EC2 instances use Identity and Access Management (IAM) roles in place of locally stored credentials. IAM roles are required for deployments that use Traffic IP addresses, auto-scaling, or appliance network management.

When you launch a new virtual machine instance in Amazon EC2, you specify the IAM role you want the instance to assume.

For more information on IAM roles, including how to create and manage roles, see the AWS documentation at <http://aws.amazon.com/documentation/>.

The Pulse Secure Virtual Web Application Firewall

Pulse Secure Virtual Web Application Firewall (vWAF) is an enterprise-level Web Application Firewall that provides attack detection and protection for the latest generation of mission-critical Web applications.

It enables centralized security monitoring, reporting and alerting and provides custom protection for your Web applications and infrastructure against external attacks.



This is an optional capability of the Traffic Manager that is only activated through the appropriate license key upgrade. Contact your support provider for more details.

Overview

vWAF is an optional component of the Traffic Manager. Once licensed and enabled in your cluster, it becomes fully integrated into the overall capability of the Traffic Manager software.

The Traffic Manager provides the infrastructure and overall control of your Web services, passing traffic to the vWAF when instructed to do so.

This chapter provides an overview of the vWAF and how it interacts with the Traffic Manager. For full instructions on configuring and using the vWAF, see the Pulse Secure Virtual Web Application Firewall: User Guide and on-line help.

Enabling the vWAF

ATTENTION

Do not enable the vWAF component on a mixed cluster of software and non-software instances of the Traffic Manager. This configuration is not supported.

To use the vWAF, obtain a suitable license key from your support provider. Once you have installed the new license, the Traffic Manager activates the **System > Web Application Firewall** page in the Admin UI. Use this page to enable, disable, and configure the vWAF component.

As with other configuration changes, enabling or disabling the vWAF on one Traffic Manager in your cluster automatically causes all other cluster members to make equivalent changes to their configuration.

vWAF Features in the Traffic Manager Admin UI

To control and configure the vWAF, use the button provided in the Traffic Manager navigation bar. This button operates as a toggle between the Traffic Manager and vWAF user interfaces.

 You must enable the vWAF component to make this button visible.

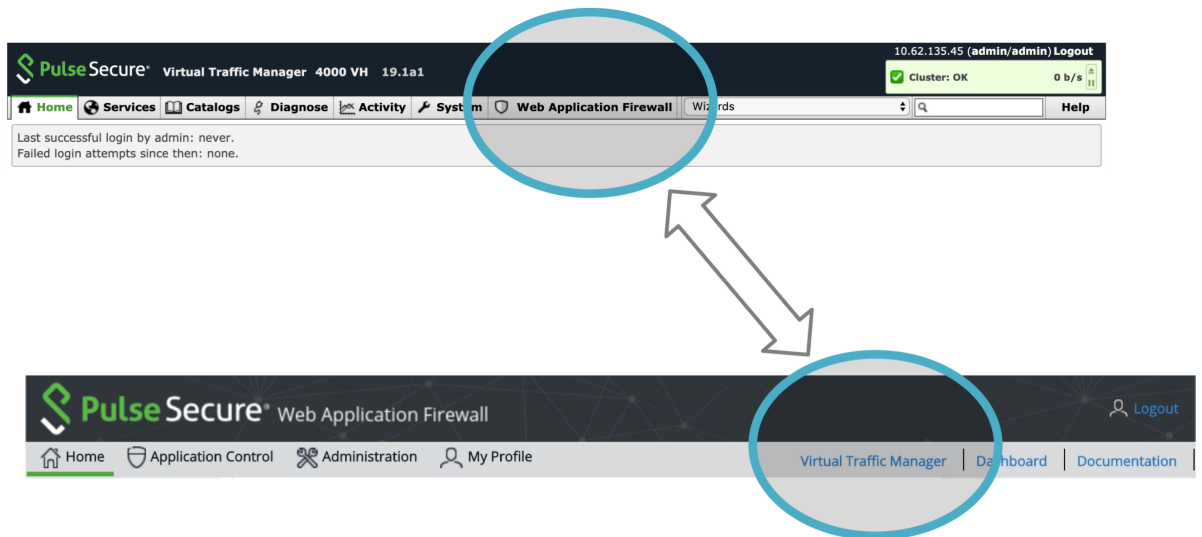

There are additionally a number of features in the main Traffic Manager Admin UI that govern vWAF communication and behavior:

- The **System > Web Application Firewall** page contains sections to enable and disable the vWAF component. It also contains low-level vWAF settings, including what network ports it uses and the number of processes it runs.
- A "Restart Web Application Firewall..." button is added to the Software Restart section of the **System > Traffic Managers** page. Certain configuration changes might require a restart of the vWAF without requiring the Traffic Manager itself to be restarted.
- The "Basic Settings" section of the **Services > Virtual Servers > Edit** page contains a control to enable or disable the vWAF for each of your HTTP services.
- The Rules catalog contains a new built-in TrafficScript rule, "Application Firewall Enforcer", that the Traffic Manager uses to maintain communication with the vWAF service.
- The Traffic Manager provides status messages in its event and audit logs relating to the vWAF service, particularly pertaining to its current running state. Any software stops, starts and restarts are recorded, along with specific configuration key changes and monitor errors. The vWAF also maintains its own local event log for attack and other event information relating to the security of your services. You can view this log through the vWAF Admin UI. See the *Pulse Secure Virtual Web Application Firewall: User Guide* for further information.
- A vWAF configuration section is present on the **Diagnose** page, which provides more detailed descriptions of any firewall problems that occur within your cluster. Should communication between the Traffic Manager and the vWAF be interrupted for any reason, the Status Applet shows that an error has occurred. Click on this error indicator to access the Diagnose page where you can see which particular problem has occurred and determine the appropriate action to remedy the situation.

The System > Web Application Firewall Page

This page contains configuration options for vWAF performance and communication.



During normal operation, you do not need to modify any of the settings in this section. The descriptions given here are for information only.

The vWAF requires a dedicated base port for communication between the Decider process and the Enforcer TrafficScript rule.

▼ **Application Firewall Decider Settings**

This section allows you to configure the application firewall Decider processes.

The number of Application Firewall decider process to run.

Decider Processes:

The port to which the Enforcer rule should send traffic so it can be distributed between the decider processes.

Decider Port:

The factory default port is suitable for the majority of deployments, but you can specify a different value if this port is unavailable on your system. The vWAF restarts automatically if you change the settings on this page.

Use the "Decider Processes" setting to tune the performance of the vWAF according to the number of CPU cores available on your system. To handle more traffic and thus improve the performance of your system, increase this value to instantiate additional Decider processes, up to a maximum of 64. However, running more processes than there are free resources can inhibit performance and degrade the service. In these circumstances, reduce the number of processes to help increase overall system performance.

Ivanti recommends that you set the number of decider processes to be the same as the number of CPU cores available on the server with the fewest CPU cores in your Traffic Manager cluster. For example, if you have two Traffic Managers in your cluster, one with four CPU cores and one with two CPU cores, set the number of decider processes to 2.

▼ Local Application Firewall Ports

This section allows you to configure additional ports used by the application firewall on this machine, this might be necessary to avoid port conflicts with existing services. To change these settings on another cluster member, you must log in to that cluster member's Administration Server.

The base port from which the Application Firewall decider processes should run. Ports will be used sequentially above this for each additional decider process that runs.

Internal Decider Base Port:

The Application Firewall Administration Server port, this port is only open on localhost.

Admin Server Port:

The Application Firewall XML Master port, this port is used on all IP addresses.

Admin Master Port:

The Application Firewall XML Slave port, this port is used on all IP addresses.

Admin Slave Port:

The Application Firewall Updater GUI Server Port, this port is used on localhost only.

Updater Admin Server port:

The Application Firewall Updater External Control Center Port, this port is used on localhost only.

External Updater Control Center Port:

The Application Firewall Updater GUI Backend Port, this port is used on localhost only.

Internal Updater Control Center Port:

The Application Firewall REST Internal API port, this port should not be accessed directly

Internal REST API Server Port:

The Application Firewall internal communication base port. The Application Firewall will use ports sequentially above this for internal communication. These ports are bound only to localhost.

Internal Communication Base Port:

The vWAF requires a number of other ports for internal communication purposes. Under normal circumstances, you do not need to modify these default values. However, to resolve port number clashes, change the required port settings to alternative values on this page.

The Enforcer and Decider

The Traffic Manager's Enforcer TrafficScript rule forwards requests to the default local port 11008 for inspection by the Decider service. The Decider returns a "Permit" or "Deny" decision and the Enforcer rule applies the decision.

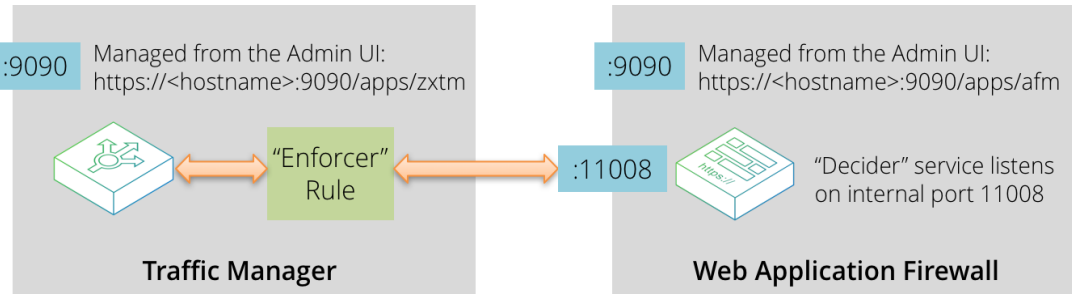

The “Enforcer” is a built-in TrafficScript rule (entitled “Application Firewall Enforcer”) that enables communication between the Traffic Manager and the vWAF. It captures all HTTP requests and responses and forwards them to the “Decider” service running on the vWAF for further consideration.

The Decider uses a set of rules stored in a configuration database to evaluate HTTP requests and to make decisions on the actions to be carried out. The Enforcer then implements these decisions whereby each request or response is accepted, modified or denied as appropriate.

For more information on the Enforcer rule, see [The Enforcer Rule](#).

The Enforcer Rule

The Traffic Manager communicates with the vWAF via the TrafficScript rule system, applying certain logic to the requests and responses generated by traffic to and from your Web applica When you enable the vWAF, a special rule entitled “Application Firewall Enforcer” (the Enforcer) is created to instruct the Traffic Manager to forward HTTP traffic to the Decider service. To attach this rule to your virtual servers, enable the **Web Application Firewall** setting on the **Virtual Server > Edit** page.

You cannot enable, disable, remove, or edit the Enforcer rule in the same way as other rules, but you can move it to alter the TrafficScript rule execution order. This is useful if you need to process requests or responses first. For example, you might have an additional rule that whitelists certain requests ahead of executing the Enforcer, as per the following TrafficScript:

```
connection.data.set( "enforcer.whitelist", 1 );
```

Like other rules, the Enforcer resides in the Rules Catalog. While you cannot delete the Enforcer rule, you can use the **Save As** functionality to create a copy.



Such copies look like, and provide the same options as, the original Enforcer rule. However, you should use them like traditional rules. In other words, you assign them to virtual servers, pools and rules in the normal way. Only the original Enforcer rule is assigned using a virtual server’s **Web Application Firewall** setting.

You can also set a number of configurable data items for the Enforcer. Click the rule name, or the **Edit** link, to access its settings page. The actual TrafficScript text is not immediately visible - click the **Rule text** link to display it. Note that it is in a binary format and is only partially human-readable.

The top of the rule text shows a number of configurable parameters. The Traffic Manager automatically updates the rule text with any modifications you make:

- **allowonerror**: Set to 1 to allow all traffic if the Decider is un-contactable. (default: 0)
- **backend_timeout**: The number of seconds to wait for the Decider before timing-out. (default: 5)
- **bypass_enforcer_max**: Set to 0 to block requests larger than `enforcer_max_body_size` from bypassing the vWAF. (default: 1)
- **bypass_file_types**: A space separated list of file extensions to exempt from the vWAF. (default: "css js png jpg gif")
- **debug**: Set to 1 to enable debugging mode. Use this option to provide a more verbose error output to assist in tracking down problems. (default: 0)
- **discard_on_reject**: Set to 1 to close rejected connections without sending an error message.
- **enforcer_max_body_size**: The maximum body size, in bytes, that the vWAF processes. Requests larger than this limit are blocked or bypassed depending on the setting of **bypass_enforcer_max**. (default: 2097152)



You should not normally need to modify these settings. Doing so may inhibit the ability of the rule to function correctly, so only proceed if you are fully aware of the consequences.

User Management

The Traffic Manager maintains user and group access with the vWAF. It creates a new vWAF user with the same level of authorization as a member of the "admin" group in the Traffic Manager Admin UI¹. Performing usual administrative tasks does not require additional access privileges or login processing. Click **Logout** in either UI to log the user out of both applications.

¹Specifically, a vWAF user record is not created UNTIL you first access the vWAF Admin UI from the Traffic Manager Admin UI. If the username already exists, no new user is created and the existing user record is used instead.

ATTENTION

If you delete a user from the Traffic Manager, it is not automatically removed from the vWAF. An administrator must perform this step manually.

Members of other user groups in the Traffic Manager, such as "Demo" or "Monitoring", only gain access to the various vWAF UI features if the correct permission settings exist on the **System > Users > Groups > Edit Group** page. The Traffic Manager provides settings in the **System** section for this purpose:

- **Application Firewall:** Controls access to the **System > Web Application Firewall** page in the Traffic Manager Admin UI.
- **Application Firewall > Administration:** Controls access to the vWAF Admin UI (through the toolbar button shown earlier).



You can override the automatic admin user creation mechanism by pre-defining user accounts in the vWAF Admin UI (if, for example, you want to specify limited access, or use a non-admin group). A user with the same name on the Traffic Manager will then have only the desired access in the vWAF Admin UI.

Updating Your Software

The vWAF includes a capability known as the Updater that is responsible for handling updates to the vWAF software component. You can access the Updater through the **Administration > Cluster Management** tab of the vWAF Admin UI. See the Pulse Secure Virtual Web Application Firewall: User Guide and on-line help for more information.

TrafficScript Rules

This chapter describes TrafficScript rules, including how to create new rules and apply them to your services.

Overview



Some variants of the Traffic Manager do not support TrafficScript rules or XML capabilities, or have limited support (RuleBuilder only). Full support can be obtained through a software or license key upgrade.

The Traffic Manager section of the Pulse Community Web site contains a large amount of examples and documentation describing how to use TrafficScript rules to solve a range of network and application problems. See <https://community.pulsesecure.net> for more information.

You can customize the Traffic Manager using your own traffic management rules. These rules are created using a scripting language called TrafficScript.

The Traffic Manager executes TrafficScript rules whenever it receives a new connection or network request, whenever it receives a response from a node, and at the logical completion of a transaction. The rules can inspect the incoming and outgoing data in the connection, and other aspects such as the remote client address.



TrafficScript rules can use regular expressions to search, match, and substitute data. Before using regular expressions in your rules, read and understand the security considerations in [Using Regular Expressions](#).

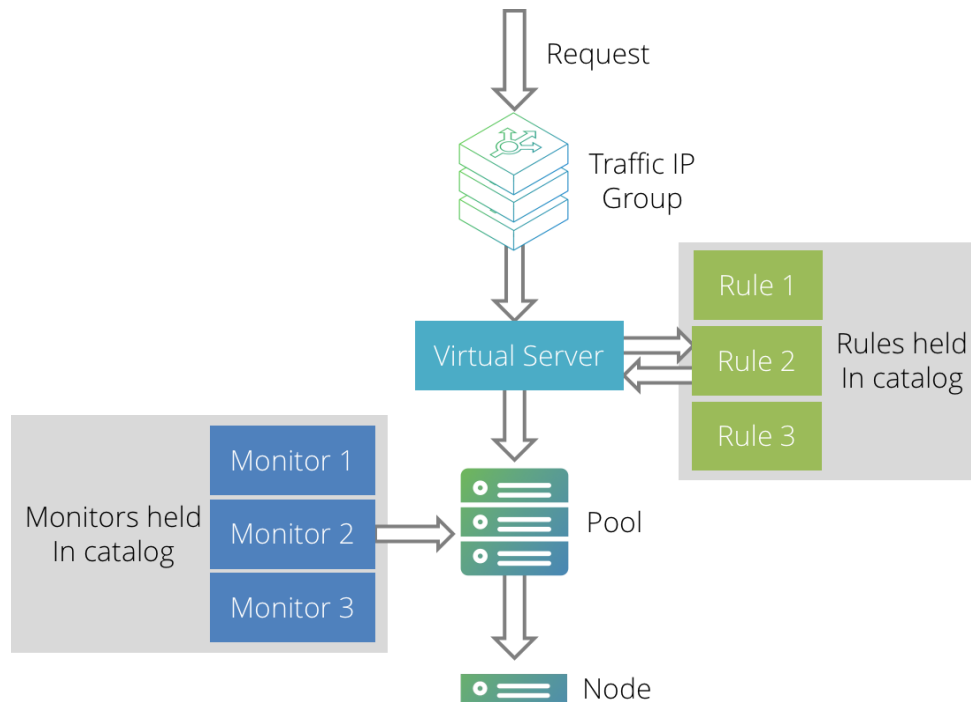

A TrafficScript rule can modify the request or response (for example, rewriting the URL or headers in an HTTP request), set session persistence parameters, selectively log transactions, or inform the Traffic Manager how to route the request to the most appropriate pool.

This makes it possible to control precisely how the Traffic Manager manages your traffic by using rules designed to meet your own hosting requirements.

TrafficScript Example

The following TrafficScript rule can be used with HTTP requests. It handles the request as follows:

- Requests for "www.example.co.uk" are rewritten to "www.example.com".
- Requests for .jsp pages are routed to a set of application servers (the pool named "JSPServers").
- Requests for URLs beginning "/secure" are only allowed during office hours.

```
# Rewrite host header if necessary
if( http.getHostHeader() == "www.example.co.uk" ) {
    http.setHeader( "Host", "www.example.com" );
}

$path = http.getPath();
```

```
# Give .jsp requests to the "JSPServers" pool
if( string.endsWith( $path, ".jsp" ) ) {
    pool.use( "JSPServers" );
}

# Deny access to /secure outside office hours
if( string.startsWith( $path, "/secure" ) ) {
    if( sys.time.hour() < 9 || sys.time.hour() >= 18 ) {
        connection.discard();
    }
}
```

The next rule can be used with HTTP responses. It processes the response as follows:

- If the status code is 404 or 5xx, retry the request a maximum of three times.
- If the response contains references to `www.example.co.uk`, rewrite it by changing these references to `www.example.com`.

```
$code = http.getResponseCode();
if( $code == 404 || $code >= 500 ) {
    if( request.getRetries() < 3 ) {
        # Avoid the current node when we retry,
        # if possible
        request.avoidNode( connection.getNode() );
        request.retry();
    }
}

# We're only going to process text/html responses, so
# break out of the rule if the response is of a
# different type...
if( http.getResponseHeader( "Content-Type" ) != "text/html" ) break;

# getResponseBody automatically de-chunks and uncompresses
# the response if required
$response = http.getResponseBody();

if( string.contains( $response, "www.example.co.uk" ) ) {
    $response = string.regexsub( $response, "www.example.co.uk", "www.example.com", "g"
);
```

```
    http.setResponseBody( $response );  
}
```

TrafficScript Documentation

The syntax and functions of the TrafficScript language are documented fully in *Pulse Secure Virtual Traffic Manager: TrafficScript Guide*. You can access this guide from the Traffic Manager product page on the Ivanti Web site at www.ivanti.com.

The TrafficScript edit page also includes a quick reference link to the functions available. To view the reference, click the **TrafficScript Reference** link when editing a rule.

For a description of how to create rules, see [Creating a Rule in the Catalog](#).

Applications of Rules on the Traffic Manager

Virtual servers typically use rules to select appropriate pools to handle requests. The rule can inspect any part of the request, possibly modify it, and decide which pool should handle the request.

You can use a rule to dictate session persistence information to a pool. After inspecting the request, the rule can use the `connection.setPersistenceKey()` function to provide a string to persist on. This string is used by the Universal session persistence method to identify the session the request belongs to.

Rules can be used to check the response from the server and modify it, or even retry the request (if possible) if a transient error was detected.

Rules can override the classes assigned to a connection by the virtual server or the pool. This way, they can specify custom behavior for each connection; connections to a slow resource can be given a longer response time tolerance for example. Classes you can assign in this way include Service Level Monitoring, Session Persistence and Bandwidth Management.

Service Protection classes can use rules. If you have associated a service protection class with your virtual server, it inspects the incoming packets. The class may use a rule to check the packet for a match with known worms or viruses. This rule is executed before the main processing of the virtual server is carried out.

Session persistence and service protection applications of rules are covered in [Session Persistence](#) and [Service Protection](#) respectively.

Using a Rule on the Traffic Manager

TrafficScript rules are stored in the Rules Catalog. You can use the Rules Catalog to create rules, upload them from an external source, modify or duplicate them, and delete unused rules as required.

To access the Rules Catalog, click **Catalogs > Rules**.

You can configure a virtual server to execute one or more rules from the catalog each time it receives a new request or response, or at completion of a transaction. This way, several different virtual servers can use the same rule, and modifications to the rule take effect on all virtual servers.

To use a rule, first create or upload a new rule in the catalog. Then configure your virtual server to use the rule (click **Services > Virtual Servers > Rules** and add the rule using the settings provided).

Creating a Rule in the Catalog

To create a new rule:

1. Click **Catalogs > Rules Catalog**.
2. In the "Create new rule" section, enter a name for your rule.
3. To write the rule in TrafficScript, click **Use TrafficScript Language**. To use the RuleBuilder, click **Use RuleBuilder**.
4. Click **Create Rule**.

Using the RuleBuilder



Your license key might restrict the availability of certain RuleBuilder options and features and the ability to use TrafficScript. If you encounter problems using some of the features described here, consult your Support Provider who can advise you on the best course of action to upgrade your software or license.

The RuleBuilder allows you to select conditions on the request to be examined, and actions that follow if any or all of these conditions are met.

You can add conditions based on the client's IP address and port, HTTP parameters, cookies, or the URL requested. Whenever you create a condition, extra text boxes appear for you to fill in the parameters for that item.

Rules Catalog

Rule: Content-based routing

Name: [? RuleBuilder Reference](#)

Notes:

Conditions

Any of the conditions must be met before executing the rule's actions:

URL Path starts with

OR

URL Path ends with

Actions

The following actions will be executed:

Choose Pool

Apply Changes

| Conditions | Actions |
|-------------------------------|---------|
| Requests and Responses | |
| Remote IP Address | |
| Local IP Address | |
| Remote Port | |
| HTTP only | |
| SIP only | |
| RTSP only | |
| Responses Only | |
| Response Body | |
| HTTP only | |
| SIP only | |
| RTSP only | |

You can then select a series of actions for the rule to carry out. Parts of the request can be altered and the Traffic Manager can write log messages before a final action is performed. The possible final actions are to choose a specified pool, or to drop the connection; not more than one final action can be carried out, but a rule is not required to have a final action.

For example, you might construct a rule such as:

```

IF
    URL Path starts with /servlet
OR
    URL Path ends with .jsp
THEN
    Choose Pool: Servlet Runners

```

Requests whose URL path does not start with “/servlet” or end in “.jsp” (such as requests for static HTML content) are ignored by this rule. A virtual server applying this rule can use a separate rule to deal with requests for other pages, or assign them to its default pool.

When you are happy with your rule, click **Update**.

You can also convert your rule to TrafficScript. The TrafficScript language gives you a much wider range and structure of possible conditions and actions. You can click **Preview Rule as TrafficScript** to see what the TrafficScript rule would look like, and use the **Convert Rule** button to convert your rule permanently.

When you begin to use the Traffic Manager's rules, you could start by using the RuleBuilder to implement simple rules. Examine the corresponding TrafficScript rule to familiarize yourself with the TrafficScript syntax. When you need to write a complex rule, you could use the RuleBuilder to prototype a simple version; once you have reached the limits of the capabilities of the RuleBuilder, proceed by converting the rule to TrafficScript for further editing.

Special variables

There are several special variables that can be included in the text boxes for RuleBuilder which are expanded to TrafficScript functions. These allow the generation of more dynamic rules, with extra flexibility.

For example, if you create a rule that sets the HTTP header "X-Forwarded-For" to the value %REMOTE_IP%, then the header will be set to the IP address of the client connecting to the Traffic Manager.

The special variables are as follows:

- **%REMOTE_IP%**: replaced with the remote IP of the client connection (TrafficScript function `request.getRemoteIP()`)
- **%REMOTE_PORT%**: replaced with the remote IP of the client connection (TrafficScript function `request.getRemotePort()`)

Writing a TrafficScript Rule

The TrafficScript editing page shows a form where you can enter a text description of the rule, type the rule and check the syntax before compiling it. You may wish to write the rule in a separate text editor before pasting it in.

Rules Catalog

Rule: TEST RULE 1

Name: ? TrafficScript Reference

Notes:

Rule: (modified)

```

1 $path = http.getPath();
2 if( string.startsWith( $path, "/secure" ) ) {
3   pool.use( "Secure Site" );
4 } else {
5   pool.use( "Web Site" );
6 }
7
8
9
10
11
12
13
14
15
16
17
18
19
20

```

Rule compiled successfully

Available Pools

Intranet
Olympus
Secure Site
Servlet Runners
Web Site
discard

Click the **TrafficScript Reference** link to view the quick function reference, and use the **Check Syntax** button to check your rule. When you have finished, click the **Update** button.

 Some TrafficScript functions and RuleBuilder conditions and actions are appropriate only in request rules, response rules, or transaction completion rules specifically. For example, a function that modifies a parameter of a request has no effect if used in a response rule (because the request has already been submitted to a node). Equally, any transaction completion rule that attempts to use a function with side-effects for the connection (for example, `http.setResponseHeader()`, `connection.discard()`) is disallowed. See the Online Help or *Pulse Secure Virtual Traffic Manager: TrafficScript Guide* for descriptions of each TrafficScript function and RuleBuilder conditions and actions.

Uploading a Rule to the Catalog

The Traffic Manager supports uploading of previously created TrafficScript rules into the Catalog. Your rules should be in plain text, and the Traffic Manager uses the full filename (including extension) as the rule name.

 The Traffic Manager performs a syntax check on the uploaded rule file. Warnings and errors are displayed on the Rule Catalog page, the Diagnose page, and in the Event Log.

To upload a rule to the Catalog

1. Click **Catalogs > Rules Catalog**.
2. In the "Upload an existing rule" section, click **Choose file** to select a rule file from your local filesystem.
3. Choose whether to overwrite existing rules that have the same name as your filename.
4. Click **Upload Rule**.

Applying a Rule to a Virtual Server

A newly added rule is not yet in use by the Traffic Manager. To use a rule, add it to your virtual server configuration.

To configure a virtual server to use a rule

1. To access the **Virtual Servers > Edit** page for your virtual server, click the **Services** button and then the **Virtual Servers** tab. Click the name of your virtual server.
2. Click the **Rules** link. This presents you with lists of request rules, response rules, and transaction completion rules currently in use for your virtual server.
3. To add a new rule to a list, use the "Add rule:" option in each section. Choose a rule from the drop-down list and click **Add rule**.
4. Rules are executed in a specified order. If the first rule does not make a final decision about a transaction, the second rule is tested, and so on. Use the drag handle at the left side of each rule bar to move a rule within the list.

For most protocols, you can specify whether the rule should be executed just once (against the first request or response), or against every request and response in the protocol dialogue.

In RTSP and SIP the rules are automatically executed on each individual request or response that passes through the Traffic Manager.

This option is not necessary for HTTP virtual servers because HTTP is a single request-response protocol, and requests within a keepalive connection are processed independently.

You can test the effect of a new rule by enabling and disabling it for your test virtual server.

Example Rules

This section provides a series of examples to show how the Traffic Manager might use TrafficScript rules to inspect and manipulate the traffic to your services.

Routing by Content Type

This example inspects the URL path in an HTTP request. It chooses a pool to handle the request according to the content type found in the URL path.

Before creating the rule, set up pools called "windows", "java", and "linux" respectively.

```
$path = http.getPath();
if( string.endsWith( $path, ".jsp" )) {
    pool.use( "java" );
} else if( string.endsWith( $path, ".asp" )) {
    pool.use( "windows" );
} else {
    pool.use( "linux" );
}
```

Restricting Access Based on Time of Day

This example allows access to a particular service only during typical office hours (in this case, between 9am and 6pm, Monday to Friday). It discards all connections that occur outside these times.

```
$dayofweek = sys.time.weekDay();
$hourofday = sys.time.hour();

# $dayofweek: Sunday is 1, Saturday is 7
# $hourofday: office hours are between 9am and 5:59pm
if( $dayofweek == 1 || $dayofweek == 7 || $hourofday < 9 || $hourofday >= 18 ) {
    connection.discard();
}
```

In practice, it might be more appropriate to direct restricted traffic to a separate "error pool" of servers rather than just dropping the connection without warning. The servers in the error pool would be configured to return an appropriate error message before closing the connection. The procedure for doing this depends on the protocol being balanced.

Customer Prioritization

This example inspects the cookie in an HTTP request. It uses the value of the cookie to determine which pool to select. One pool is faster than the other because it contains machines reserved for premium users.

A company has a customer base divided into "gold" and "silver" membership. It wants to give priority to gold customers and has five servers, yellow, green, blue, black, and purple.

Two pools are created: "standard", for silver customers, containing machines yellow, green and blue; and "premium", for gold customers, which includes all five servers. Thus, black and purple are only available to gold customers.

The site uses a cookie login system, with the customer type encoded in the cookie. The Traffic Manager can differentiate between membership levels and send traffic to the correct pool:

```
$cookie = http.getHeader( "cookie" );
if( string.contains( $cookie, "gold" )) {
    pool.use( "premium" );
} else {
    pool.use( "standard" );
}
```

Managing Levels of Service

This example tags premium customers with a "premium" Service Level Monitoring (SLM) class, and directs them to the "premium" pool.

Non-premium customers can share the premium pool if the premium SLM class is functioning within its tolerance, but are directed to the "standard" pool if the premium SLM class is running too slowly.

```
# $isPremium could be based on the presence of a
# login cookie, the contents of the shopping cart,
# or even the remote address of the client.

if( $isPremium ) {
    connection.setServiceLevelClass( "premium" );
    pool.use( "premium" );
} else {
    if( slm.conforming( "premium" ) == 100 ) {
        pool.use( "premium" );
    } else {
```

```

        pool.use( "standard" );
    }
}

```

Routing Based on XML Traffic

TrafficScript includes support for parsing XML documents using XPath, an industry-standard language used to query XML documents.

XML documents are used by SOAP-based protocols such as Web services, and enable complex data to be exchanged and understood automatically without user intervention.

An XML document is organized into a tree structure of nodes¹. Each node can contain a piece of data, or further nodes. XPath can navigate through these nodes to extract specific data from the XML document; this data can then be used by the Traffic Manager to make routing decisions on the traffic.

The XPath 1.0 specification is available at <http://www.w3.org/TR/xpath>.

Example: Google Search Request

The Google™ search engine has a Web services interface that accepts SOAP requests for search queries. A request for a search for Ivanti, Inc. would consist of an HTTP POST containing the following XML body data:

```

<?xml version="1.0" encoding="UTF-8"?>
<SOAP-ENV:Envelope
  xmlns:SOAP-ENC="http://schemas.xmlsoap.org/soap/encoding/"
  SOAP-ENV:encodingStyle="http://schemas.xmlsoap.org/soap/encoding/"
  xmlns:SOAP-ENV="http://schemas.xmlsoap.org/soap/envelope/"
  xmlns:xsi="http://www.w3.org/1999/XMLSchema-instance"
  xmlns:xsd="http://www.w3.org/1999/XMLSchema">
  <SOAP-ENV:Body>
    <namespace1:doGoogleSearch xmlns:namespace1="urn:GoogleSearch">
      <key xsi:type="xsd:string">googleUniqueID</key>
      <q xsi:type="xsd:string">Ivanti, Inc.</q>
      <start xsi:type="xsd:int">0</start>
      <maxResults xsi:type="xsd:int">10</maxResults>
      <filter xsi:type="xsd:boolean">>false</filter>
      <restrict xsi:type="xsd:string"/>
    </namespace1:doGoogleSearch>
  </SOAP-ENV:Body>
</SOAP-ENV:Envelope>

```

¹Nodes discussed in this context are unrelated to the Traffic Manager's back-end pool nodes.

```

        <safeSearch xsi:type="xsd:boolean">false</safeSearch>
        <lr xsi:type="xsd:string"/>
        <ie xsi:type="xsd:string">latin1</ie>
        <oe xsi:type="xsd:string">latin1</oe>
    </namespl:doGoogleSearch>
</SOAP-ENV:Body>
</SOAP-ENV:Envelope>

```

Note that the SOAP body contains a doGoogleSearch node. This contains the parameters of the search request.

An Internet service might implement or proxy doGoogleSearch requests, and the Traffic Manager might be used to manage the traffic to this service.

For example, it may be necessary to split doGoogleSearch requests according to the specified maximum number of results. If maxResults is greater than 100, the request is to be sent to pool googleLarge; otherwise it should be sent to pool google.

A TrafficScript rule can use the functions `xml.XPath.MatchNodeSet()` and `xml.XPath.MatchNodeCount()` to query the SOAP request body and test XML nodes:

```

# Read the entire body of the SOAP/HTTP request
$body = http.getBody();

# XML parameters lie in the "urn:GoogleSearch" XML
# namespace:
$googlens = "xmlns:googlens=\"urn:GoogleSearch\"";

# Test for the presence of a "doGoogleSearch" node.
# If present, get the value of the "maxResults"
# parameter and choose the pool

if( xml.XPath.MatchNodeCount( $body, $googlens, "//googlens:doGoogleSearch" ) ) {
    $maxResults = xml.XPath.MatchNodeSet( $body, $googlens,
                                           "//googlens:doGoogleSearch/maxResults/text()"
    );

    if( $maxResults >= 100 ) {
        pool.use( "googleLarge" )
    } else {
        pool.use( "google" );
    }
}

```

}

Providing Authentication for your Services

This chapter describes how the Traffic Manager can authenticate users remotely against external services.

Overview

When a user connects to a service provided through the Traffic Manager, their credentials can be validated against the records held at a remote service rather than on the Traffic Manager itself.

The Traffic Manager supports a number of common mechanisms to provide authentication and authorization of user requests:

- Using TrafficScript rules to query remote LDAP authentication services
- Using SAML (Security Assertion Markup Language) to perform authentication handshakes with a third-party identity provider
- Configuring the Traffic Manager for KCD (Kerberos Constrained Delegation)



Some mechanisms might be license key controlled. See your support provider for details.

This chapter discusses support for TrafficScript-based authorization and SAML authentication. For a complete description of the Traffic Manager's support for KCD, see instead [Kerberos Constrained Delegation Support](#).

Using TrafficScript Rules with Remote LDAP Authenticators

To use authentication in your TrafficScript rules, first create remote LDAP authentication service definitions in the Authenticators Catalog (**Catalogs > Authenticators**). Authenticators created in this manner can be accessed through the `auth.query()` function from within a TrafficScript rule. This rule can then be added to a virtual server handling the service to be authenticated.



TrafficScript is a license-controlled feature. The functionality described here might not be available in all product variants. Contact your support provider for more details.

Configuring Authenticators

To create and edit remote LDAP authenticator records, use the **Catalogs > Authenticators** page of the Admin UI. To create a new authenticator, provide a name, host, and port in the “Create New Authenticator” section, then click **Create Authenticator**. The Traffic Manager displays the Authenticator edit page, containing all basic and LDAP settings for the new authenticator. You must complete configuration of all LDAP settings for your authenticator to work correctly.

The Authenticator edit page contains the following configuration keys:

| Setting | Description |
|--------------------|---|
| Name | <p>The identifying name given to this authenticator. This name will be used in the <code>auth.query()</code> function call, within an authenticating TrafficScript rule.</p> <p>If the authenticator is renamed here, any rules referencing this authenticator will be automatically updated to use the new name.</p> |
| Host | The host-name or IP address of the LDAP server to connect to. |
| Port | The port of the LDAP server to connect to. |
| Note | A description of this authenticator. |
| ldap!bind!dn | <p>The Distinguished Name (DN) of the 'bind' user. The bind user is used to contact the LDAP server and search for the record belonging to the user being authenticated.</p> <p>The bind user must have permission to search for and read user records on the LDAP server.</p> <p>If no bind user is specified then the Traffic Manager will attempt an anonymous login to search for the user being authenticated.</p> |
| ldap!bind!password | The password for the bind user specified in ldap!bind!dn . |
| ldap!filter | <p>A filter used to extract the unique user record located under the base DN. The string <code>%u</code> will be replaced by the username supplied when the authenticator is invoked.</p> <p>Examples of common LDAP filters include <code>sAMAccountName=%u</code> for Active Directory, or <code>uid=%u</code> for some UNIX LDAP schemas.</p> |

| Setting | Description |
|--------------------|---|
| ldap!filter!basedn | <p>The base Distinguished Name (DN) under which the Traffic Manager will search for the record of the user being authenticated.</p> <p>The entries for all users that are to be authenticated by this LDAP authenticator must appear under the DN specified here.</p> <p>A typical base DN might be OU=users, DC=mycompany, DC=local.</p> |
| ldap!attr | <p>If the Traffic Manager finds a record for the user being authenticated on the LDAP server it can fetch back additional information from that record. This information can be used to perform additional checks on the user being authenticated, such as restricting access based on which group the user belongs to.</p> <p>To fetch back specific attributes from the user's record, a space- or comma-separated list of attribute names can be specified in the ldap!attr setting.</p> <p>To fetch back all attributes from the user's record, set ldap!attr to '*'.</p> <p>If the setting is blank, no additional attributes will be retrieved from the server.</p> <p>Any attributes retrieved from the user's record will be available in the return value from the TrafficScript function that requested the authentication.</p> |
| ldap!ssl | <p>This setting determines whether or not the connection to the LDAP server will be SSL-encrypted. The method by which the SSL connection is established can be specified in the ldap!ssl!type setting.</p> |
| ldap!ssl!type | <p>This setting specifies the method by which an SSL connection to the LDAP server is established. It is used only if ldap!ssl is set to "Yes".</p> <p>The available methods are:</p> <p>LDAPS: The Traffic Manager will establish a secure connection to the LDAP server before any LDAP messages are sent.</p> |

| Setting | Description |
|----------------|--|
| | Start TLS: The Traffic Manager will use the LDAPv3 Transport Layer Security extension to establish a secure connection to the server. |
| ldaps!ssl!cert | <p>When connecting to the remote LDAP server over SSL, the Traffic Manager ensures that the server's certificate is signed by the certificate authority specified by this setting.</p> <p>If the server sends a certificate that is not signed by the certificate authority specified here, or the certificate does not match the value specified as the server's identity given in Host, an error is returned to the TrafficScript function using the authenticator.</p> <p>If no certificate authority is specified, the server's certificate is not validated.</p> |

Configuring the TrafficScript Rule

To use remote authentication within a virtual server, assign an authentication rule to it as a request rule. This rule should contain a call to the function `auth.query()` with the arguments shown here:

```
auth.query( authenticator, user, [password] );
```

This queries the named authenticator for information about user and, if supplied, checks that password matches the password on record for that user. It returns a hash containing two values, "OK" and "Error", which are set according to the results of the verification. The result can also contain additional information returned by the authenticator, such as the Distinguished Name of the user that was queried. Refer to the *TrafficScript Reference* for more details.

To learn more about creating TrafficScript rules, see [TrafficScript TrafficScript Rules](#).

The example below shows how you might use the `auth.query()` function to provide user verification based on a previously created Authenticator called "ldap":

```
# Verify the user's password using an LDAP
# authenticator called 'ldap'
$auth = auth.query( "ldap", $user, $pass );
if( $auth['Error'] ) {
    log.error( "Error with authenticator 'ldap': " . $auth['Error'] );
    connection.discard();
} else if( !$auth['OK'] ) {
```

```
# Unauthorised
http.sendResponse( "403 Permission Denied", "text/html",
                  "Incorrect username or password", "" );
}

# Allow through members of the 'admin' group using
# the 'group' attribute returned by the authenticator
if( $auth['group'] != "admin" ) {
    http.sendResponse( "403 Permission Denied","text/html",
                    "You do not have permission to view this page","" );
}
```

Configuring the Virtual Server

Once you have a rule with the appropriate settings configured, you must assign it to the virtual server on which you want to enable authentication:

1. Go to the **Services > Virtual Servers** section of the Admin UI and select the virtual server on which you want to enable authentication.
2. Click the **Rules** section.
3. Under "Request Rules", select your authentication rule and click **Add Rule**.

Configuring the Traffic Manager as a SAML Service Provider



SAML service provider functionality is not available as standard on all Traffic Manager configurations. For more information, or to obtain a license key upgrade, contact Pulse Secure Technical Support.

SAML (Security Assertion Markup Language) is an open-standard XML-based message framework, used to exchange information concerning the authentication and authorization of user agents attempting to access an organization's web services.

SAML deployments typically involve two participant types:

- Service Providers (SPs): provide the resources to be protected
- Identity Provider (IDPs): perform the authentication and authorization checks required by your resources

An organization can deploy a secure SAML-based IDP to handle a range of authentication scenarios, from simple back-end LDAP directory services credentials-checking, through to highly complex security arrangements involving multi-factor authentication for many services across an enterprise.

The Traffic Manager has the ability to function as a SAML SP to control access to your back-end web applications. Access is only permitted when a valid SAML token is presented by the requesting user agent, who has in turn obtained the token from a defined IDP.

The SAML Message Exchange

In a typical scenario, a user’s browser connects to an SP in an attempt to access a particular service. The SP is configured to obtain prior validation, and thus redirects the browser to the IDP. The IDP then checks the identity of the user against its own records, and obtains verification that the user has appropriate privileges for the desired service. If successful, the IDP returns the browser to the SP with a SAML assertion that the user is legitimate. The SAML exchange is between the SP and IDP through the user agent, and as such your back-end services are completely insulated from, and unaware of, the security negotiation that takes place.

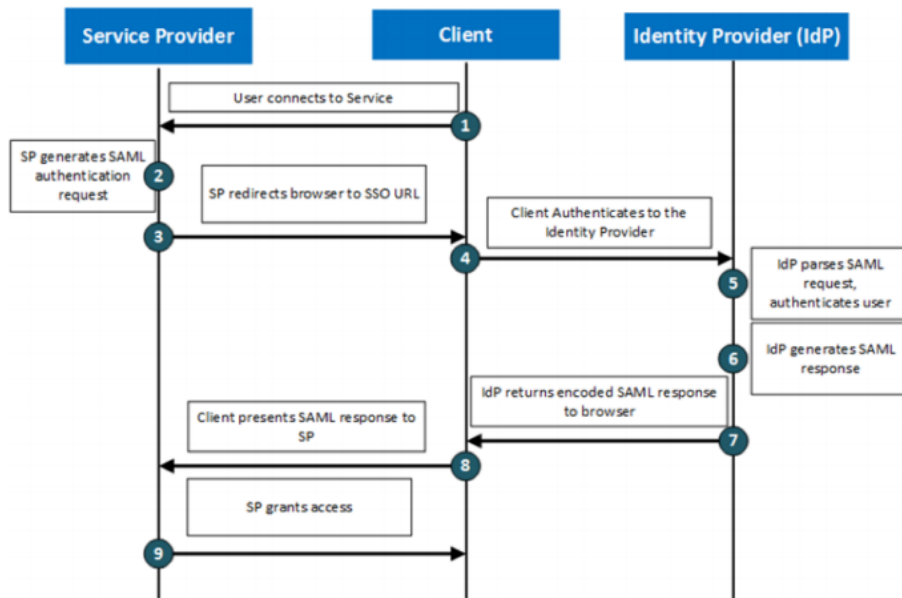

An IDP can provide authentication for multiple back-end services - commonly known as a Single Sign-on (SSO) service. Equally, an organization could employ multiple IDPs, one for each service.

Furthermore, an IDP does not necessarily need to reside in the same network as an SP. It needs only to be contactable by the user agent (typically a user's web browser). An SP must be aware of an IDP, and vice versa, through shared SAML configuration details, but they never directly communicate. SAML messages are carried by the user agent.

SAML and the Traffic Manager



The Traffic Manager supports SAML version 2.0, and allows SP-initiated authentication only. Additionally, the Traffic Manager does not support encrypted SAML assertions.

The Traffic Manager can be configured as a SAML Service Provider (SAML SP) to control access to an HTTP(S) service, and should be compatible with any SAML IDP that implements the same standard.

SAML itself has many usages (profiles) requiring various different SAML protocols with bindings to other generic network protocols. The Traffic Manager implements the "Web SSO" profile, with HTTP-Redirect and HTTP-POST bindings used for authentication request and response, respectively.

To ensure the SAML response is trusted, the Traffic Manager accepts cryptographically signed responses based on certificates stored as part of the IDP definition. For more details, see [Defining Identity Providers](#).

The Traffic Manager also maintains user session information where a SAML assertion is received from an IDP. Session data contains the identity of a logged-in user, the time that they (most recently) authenticated, and the time the SAML authentication token expires. This ensures that re-authentication can be requested when the session has timed out.

No session state is stored server-side; instead, a session cookie is created at the client side, encrypted and signed using a secret key shared across the Traffic Manager cluster using the Traffic Manager's existing session ticket mechanism. This facilitates the use of active-active Traffic Manager configurations, in that the authentication session is shared between active cluster members. To configure session cookie behavior, use the settings described in [Configuring a Virtual Server to use an IDP](#). For more information on session tickets, see [SSL Encryption](#).

The Traffic Manager includes a TrafficScript function, "http.auth.getAuthenticatedUser()", to return the name identifier of the authenticated user (in a format determined by the IDP, but typically an email address or similar). This user data could then be forwarded to the back-end service as part of, for example, an HTTP request header.

Configuring your Traffic Manager

The Traffic Manager can exchange SAML requests and responses with any compatible IDP. The Traffic Manager requires certain IDP-derived details as part of its SAML configuration, and must also provide the IDP with specific configuration items in return. To operate successfully, your SAML configuration must match on both the Traffic Manager (as the SP) and your IDP.

Configuration of your IDP varies according to the actual IDP platform used, and as such is out of scope for this document. For further information on how to configure your IDP to exchange authentication messages with the Traffic Manager, see your IDP administrator.

This section details the configuration from the perspective of the Traffic Manager only.

Defining Identity Providers

The Traffic Manager stores IDP records in the SAML Catalog. Each IDP can then be used by one or more virtual servers to add remote authentication to the services they handle. To access your IDP definitions, click **Catalogs > SAML Catalogs > Trusted Identity Providers Catalog**.

The following table lists the configuration items requires for an IDP definition:

| Key | Description |
|-----------------|--|
| Name | The name of the trusted identity provider |
| Entity ID | The identifier that the trusted identity provider sends in the "Issuer" field of the SAML assertion to identify itself. |
| URL | The URL to which the Traffic Manager should send SAML authentication requests. |
| add_zlib_header | The SAML standard uses the DEFLATE Compressed Data Format, as described in RFC 1951. Set to "No" if the identify provider adheres to this standard. Set to "Yes" if the identity provider does not adhere to this standard, and instead requires the use of the ZLib format. |
| strict_verify | Set to "Yes" to force the Traffic Manager to reject SAML responses where the <i>Conditions</i> element contains unknown attributes, or has unknown or missing elements. |

| Key | Description |
|-------------|--|
| | Set to "No" to disable strict verification, where compatibility issues might be expected. |
| Certificate | A PEM-encoded X.509 certificate containing the public key that the Traffic Manager should use to verify the integrity of received SAML assertions. |

Contact your IDP administrator for suitable values when setting up a new IDP record.

Configuring a Virtual Server to use an IDP

To apply authentication control to your service, configure the applicable virtual server as a SAML Service Provider endpoint. Click **Services > Virtual Servers > Edit > Authentication**.

The following table lists the items requires for a SAML SP endpoint configuration:

| Key | Description |
|--------------------------|---|
| auth!type | <p>The type of authentication the Traffic Manager should use for requests handled by this virtual server. Some types of authentication are protocol-specific; for example, apply only to an HTTP virtual server.</p> <p>Select one of the following supported authentication types:</p> <p>None: No additional authentication is required by the Traffic Manager.</p> <p>SAML Service Provider: The Traffic Manager requires that a valid SAML assertion is presented in order to access this virtual server. This option is available only for HTTP virtual servers.</p> |
| auth!verbose | Displays detailed messages concerning virtual server authentication in the error log. |
| auth!session!cookie_name | The name of the cookie used to store the authentication session token. |

| Key | Description |
|--------------------------------|--|
| auth!session!cookie_attributes | <p>The attributes of the cookie used to store the authentication session token. The configured attributes are appended to the cookie unaltered.</p> <p>The default attributes prevent access to the cookie by client-side APIs such as Javascript and apply a strict same site policy.</p> |
| auth!session!timeout | <p>The number of seconds of inactivity on a session after which the user must re-authenticate with the IDP.</p> <p>Re-authenticating might only mean that the IDP issues a new token; if the user has a valid session with the IDP, they might or might not need to re-authenticate at this point, depending upon the configured SSO policy.</p> |
| auth!saml!sp_entity_id | <p>A string identifier used by the IDP to determine which SAML SP redirected a user agent for authentication.</p> <p>Use a unique URL, related to the virtual server, but not referencing any actual resources on the back-end service. The URL used here is processed internally by the Traffic Manager and requests sent to it are not forwarded to the back-end, hence any resources residing at this URL become unavailable.</p> <p>If an "Audience" field is present in the SAML assertion, it must match this value.</p> <p>Your IDP administrator might ask you to provide this value in a configuration field called "Audience".</p> |
| auth!saml!sp_acs_url | <p>The URL of the SAML assertion consumer service. In other words, the URL at which the Traffic Manager should handle SAML assertions.</p> <p>Use a unique HTTPS URL (especially in a live-service production environment) that does not refer to any actual resources on the back-end service. The URL used here is processed internally by the Traffic Manager and requests sent to it are not forwarded to the back-end, hence any resources residing at this URL become unavailable.</p> |

| Key | Description |
|--------------------------|---|
| | <p>If a "Recipient" field is present in the SAML assertion, it must match this value.</p> <p>Your IDP administrator might ask you to provide this value in a configuration field called "Recipient".</p> |
| auth!saml!idp | <p>The name of the trusted IDP to which SAML authentication requests are sent, and from which SAML assertions should be trusted.</p> |
| auth!saml!time_tolerance | <p>The time tolerance, in seconds, for authentication checks.</p> <p>When checking time-stamps and expiry dates against the current time on the system, allow this much time tolerance. For example, if a SAML response contains a "NotOnOrAfter" that is 4 seconds in the past according to the local time, and the tolerance is set to 5 seconds, the response is still accepted. This setting helps prevent a lack of clock synchronization from resulting in rejection of SAML responses.</p> |
| auth!saml!nameid_format | <p>The format of the name identifier to request and expect from the identity provider. The following options are available:</p> <p>none: No specific format identifier is used in the SAML authentication request, and any string format is allowed in the subject of the SAML assertion.</p> <p>unspecified: The format identifier "urn:oasis:names:tc:SAML:1.1:nameid-format:unspecified" is sent in the SAML authentication request, and any string format is allowed in the subject of the SAML assertion.</p> <p>emailAddress: The format identifier "urn:oasis:names:tc:SAML:1.1:nameid-format:emailAddress" is sent in the SAML authentication request, and the subject of the SAML assertion must be an email address.</p> |

Troubleshooting SAML Authentication

SAML authentication typically fails at one of two points:

- The handover from the SP to the IDP
- The handover back from the IDP to the SP

In the first case, the authentication attempt usually results in an error page sent by the IDP. In the second case, the error page is sent by the SP. To obtain greater detail in the message exchange observed by the Traffic Manager, enable the virtual server setting **auth!verbose**. Additionally, the following can be useful in diagnosing problems:

- The error page, in particular if its generated by the IDP
- A Technical Support Report (TSR) from the Traffic Manager
- The IDP metadata, if the IDP supports downloading it
- A SAML logger web browser extension, if available, to capture the SAML exchange

ATTENTION

Information obtained using these methods should not contain any cryptographic secrets or end user passwords. In some cases, a SAML trace might contain the name identifier for an end user (typically an e-mail address) that is passed from the IDP to the SP. Your organizational security policy should dictate the confidentiality level applied to such data.

Java Extensions

This chapter gives an overview of the Java support available. Java can be called from TrafficScript, which allows for more powerful routing and easier traffic management.

For more in-depth details, refer to the *Pulse Secure Virtual Traffic Manager: Java Development Guide*.

Introduction to Java

Java is an object-oriented and platform-independent development language that has a large community of developers, libraries and applications. The Traffic Manager allows the use of Java extensions in TrafficScript, offering greater flexibility in traffic manipulation. These Java extensions can then be invoked from TrafficScript rules.

The Traffic Manager Java API is a way for customers and Internet Service Providers to extend the capabilities of the Traffic Manager.

Some examples of functionality available using the Java API in TrafficScript are:

- **Content processing:** Improved XML/HTML processing using specialized Java libraries.
- **Additional libraries:** ISV libraries supplied as a value-add solution, operating as pluggable extensions to the Traffic Manager to add new features.
- **Authentication:** Using RADIUS, TACACS+, LDAP, and so on, without the need to use an external Web server.

Invoking a Java Extension

Java extensions are invoked from TrafficScript or RuleBuilder rules.

Whenever a Java extension is imported into the Traffic Manager, a basic RuleBuilder rule is created with the same name as the Java Extension. The rule invokes the extension, allowing it to inspect, modify and route the traffic. You can add this basic rule to the list of request or response rules run by a virtual server.

ATTENTION

Java is disabled by default for all new Traffic Manager instances. To invoke a Java extension, first enable Java support. For more information, see [Configuring the Traffic Manager's Java Extension Runner](#).

In many cases, a particular Java extension need not be called for every single request or response; for example, it processes only requests or responses of a particular type. The Java Extension can be called conditionally by a RuleBuilder or TrafficScript rule:

```
if( http.getPath() == "/serverstatus" ) {  
    java.run( "ServerStatus" );  
}
```

Configuring the Traffic Manager to Use Java

This section introduces the process of creating, configuring and running Java Extensions on the Traffic Manager. The Java Development Guide provides a much more complete description of this process.

Requirements

To use Java Extensions with the Traffic Manager, install the Java run-time environment (JRE) version 1.5 or later. Previous versions are not supported by the Traffic Manager.

Traffic Manager virtual/cloud/appliance instances include the necessary Java software to run Java Extensions.

Compiling a Java Extension

To compile Java Extensions for the Traffic Manager you will need the following resources:

- Java Development Kit (JDK), which contains the Java compiler. The compiler can be downloaded from <http://www.oracle.com/technetwork/java/index.html>.
- Java Servlet API library: This can be found in \$ZEUSHOME/zxtm/lib/servlet.jar or downloaded from the link in the **Java Extensions** catalog.
- Traffic Manager Java Extensions API library: This can be found in \$ZEUSHOME/zxtm/lib/zxtm-servlet.jar or downloaded from the link in the **Java Extensions** catalog.

To compile a Java Extension, run the command:

```
javac -cp servlet.jar:zxtm-servlet.jar MyServlet.java
```

This creates a class file called "MyServlet.class". The above command assumes you have copied servlet.jar and zxtm-servlet.jar to the directory you are compiling from. If not, modify the command to specify the full path to each file.

You can also package up a Java extension along with any other needed classes in a single jar file. The Traffic Manager will automatically search jar files for Java extensions to use.

Loading Java Extensions onto the Traffic Manager

Java Extension class and jar files need to be added to the Traffic Manager's **Java Extensions** catalog.

To upload the Extension, click **Catalog > Java Extensions** and specify your class or jar file in the "Upload" section. If your extension depends on other Java jar files that are not included in the Java distribution, you should upload those into the catalog too.

Java Extensions Catalog

File 'Counter.jar' was uploaded successfully.

A Java Extension can manipulate connections, in a similar way to a TrafficScript rule. Extensions are invoked from TrafficScript. Please see the user manual for full instructions on building Java Extensions. You will also need to download the **Java Servlet API** and **Zeus Java Extensions API** files.

| Extension | Path | Used By | Select (all / none) |
|----------------------------------|----------------|---------|--------------------------|
| com.zeus.TestServlets.Counter | Counter.jar | Unused | <input type="checkbox"/> |
| com.zeus.TestServlets.PoolPicker | PoolPicker.jar | Unused | <input type="checkbox"/> |

Reload selected Delete selected Confirm operation

Java Libraries & Data Catalog

Any uploaded non-Java Extensions files are shown here, including other Java class/jar files.

No additional files have been uploaded.

Upload Extension / Data File

Choose to upload either a jar file containing your Java Extension code, a single class file or data files that your Java Extensions are going to use. Class files will automatically be put in the correct directory depending on their package.

File: No file chosen

Automatically create TrafficScript rule

Overwrite if file already exists:

Configuring the Traffic Manager's Java Extension Runner

The Traffic Manager includes a Java helper application called the Java Extension Runner (JRE) that hosts the Java extensions. You can control how the Traffic Manager initializes and runs this helper application using the settings in **System->Global Settings->Java Extension Settings**.

The following table lists the configuration settings available:

| Setting | Description |
|--------------|--|
| java!enabled | Enables or disables Java support in the Traffic Manager. |

| Setting | Description |
|-------------------------------|---|
| | By default, Java support is disabled for all new Traffic Manager instances. To use Java extensions in the Traffic Manager, set <code>java!enabled</code> to "Yes". |
| <code>java!command</code> | The path to the Java executable, including any command-line arguments. |
| <code>java!classpath</code> | Colon-separated list of folders where the Java classes are located. |
| <code>java!lib</code> | Specifies a folder to search automatically for libraries used by your Java extensions. Note that the Traffic Manager will not load any Java extensions from this directory. |
| <code>java!max_conns</code> | Defines the maximum number of simultaneous Java requests allowed. Additional requests will be queued and will not be processed until the former ones have been completed. This setting is per CPU core; for multicore processors, multiply this setting by the number of available processor cores. |
| <code>java!session_age</code> | Value in seconds, defining a timeout to maintain a Java session. |

To specify a Java executable, set **java!command** to the name of the executable (include the full file path if it is not the default), along with any options the JRE should be run with.

To check your setup, click **Diagnose > Cluster diagnosis** and verify that the "Java extensions" section shows no errors or warnings. The Traffic Manager should now be ready to run Java extensions.

Protocol Support

This chapter describes specific protocol support in the Traffic Manager.

Overview

The Traffic Manager load-balances and processes application traffic that is enclosed in TCP connections or UDP datagrams. Most Traffic Manager features, such as TrafficScript, load balancing, session persistence, and bandwidth management can be applied equally to all protocol types.

Where appropriate, TrafficScript functions specific to a particular protocol are included, making management and control of traffic in that protocol easier.

Basic TCP Protocols

“Generic Server First”, “Generic Client First” and “Generic Streaming” protocols are the most basic L7 protocol types that the Traffic Manager can use. They are useful when managing custom protocols or simple TCP connections because they do not expect the traffic to conform to any specific format.

Server-First Protocols

Server-first is the simplest TCP protocol type. When the Traffic Manager receives a connection from a client, it immediately runs any TrafficScript request rules, then immediately connects to a back-end server. It then listens on both connections (client-side and server-side) and passes data from one side to the other as it comes.

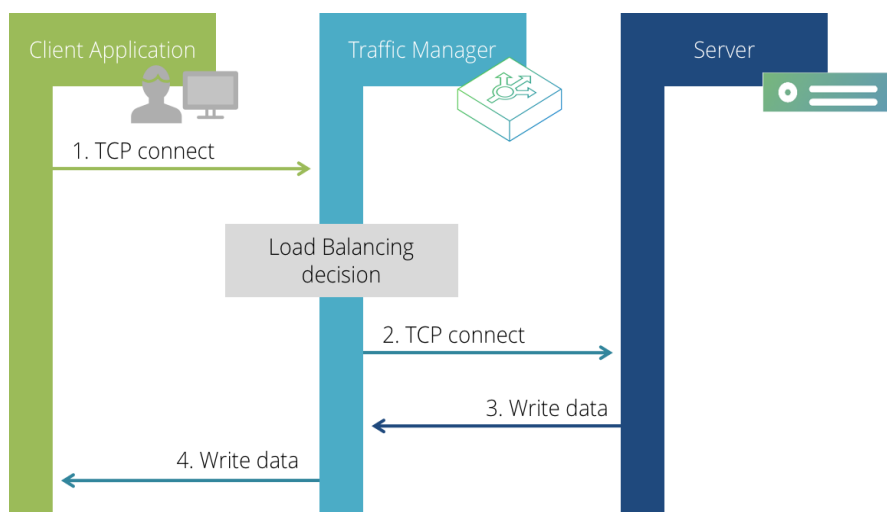

Server-first protocols include one-shot protocols such as Time (where the server writes the response data, then immediately closes the connection), or complex protocols like MySQL (where the server opens the dialog with a password challenge).

The virtual server protocol type "Generic Server First" is most suitable for protocols where the server speaks first. In practice, the design of most protocols means that "Generic Client First" is more appropriate.

Client-First Protocols

Client-first is a modification of server-first, appropriate for protocols where the client connects and sends a request before the server replies. You can use the "Generic Client First" protocol type to inspect a client's request and select a server pool that should be used to select the server node to be used.

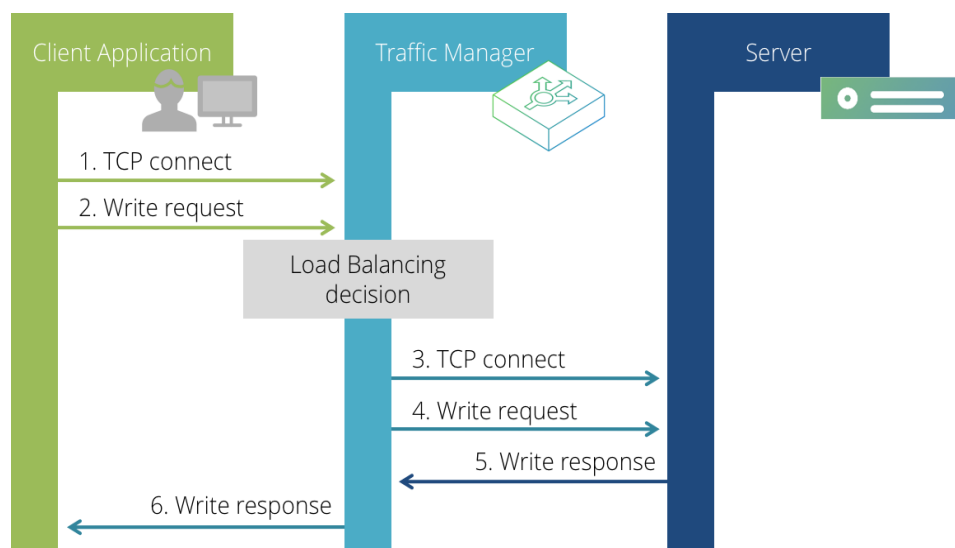

The Traffic Manager is only alerted when a client connection has been established and data has been received. The Traffic Manager then proceeds in the style of server-first: runs TrafficScript rules, connects to the back end and relays data back and forth.

Rules Processing in Detail

The Traffic Manager alternates between running TrafficScript request and response rules. It will run the request rules when the first data from the client is received; the request rules may block if they use functions like `request.getLine()` or `request.get()` to read further data from the client.

Once the request rules have completed, the Traffic Manager will forward any further data it receives from the client on to the server. The Traffic Manager will run the response rules as soon as it receives any data (in other words, a "response") from the server; these response rules may also block.

The Traffic Manager will then continue to forward any further data from the server to the client; the Traffic Manager will wait for any data from the client and run the Request rules again; in this manner, the Traffic Manager switches between waiting for request data to run request rules, and waiting for response data in order to run response rules.

Note that rules that are configured as "Run Once" rather than "Run Every" will only be run on the first server or client data, not on subsequent iterations.

Server-First with "Server Banner"

Server-first with a server banner is a different optimization for "server-first" to cater for servers which broadcast a banner on connect, such as SMTP. "Server-first with server banner" allows you to inspect and make a load-balancing decision based on the client's request.

When a client connects, the Traffic Manager immediately writes the configured server-first banner to the client, then proceeds as a regular client-first connection. In addition, the Traffic Manager slurps and discards the first line or data (terminated by a newline) that the server sends.

Use TrafficScript rules to inspect the client's request data before making your load-balancing decision.

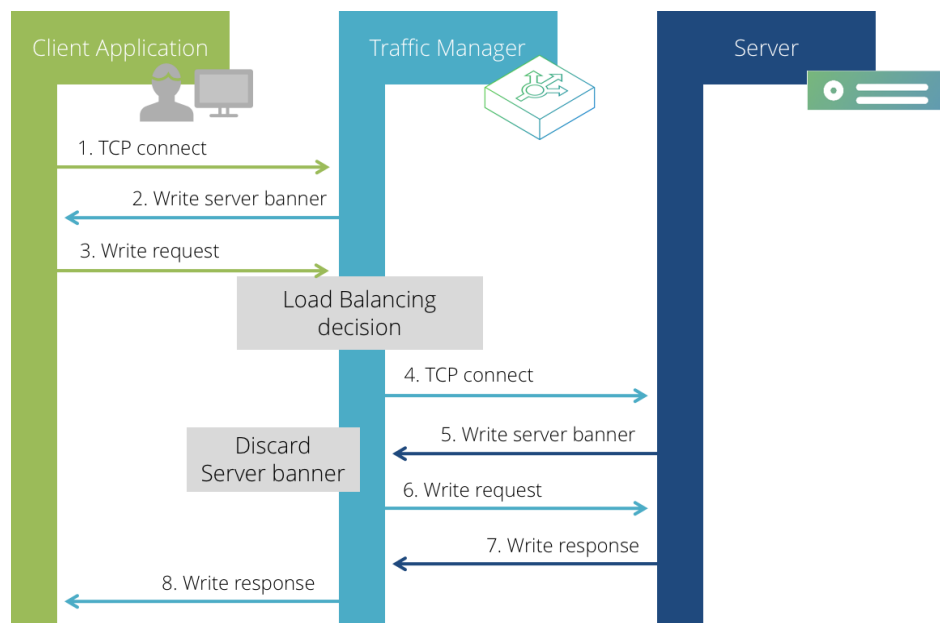

To configure this behavior, select the "Generic Server First" protocol type and configure a banner message in the Protocol Settings section in the virtual server configuration.

Generic Streaming Protocols

If you are using a protocol that does not require the server to respond to every message that the client sends, or if you need extra flexibility when processing data in TrafficScript, you can choose the "Generic streaming" option. This server type allows either the client or server to send the first message when a connection is established and also allows TrafficScript rules to be invoked whenever data is received on the connection.

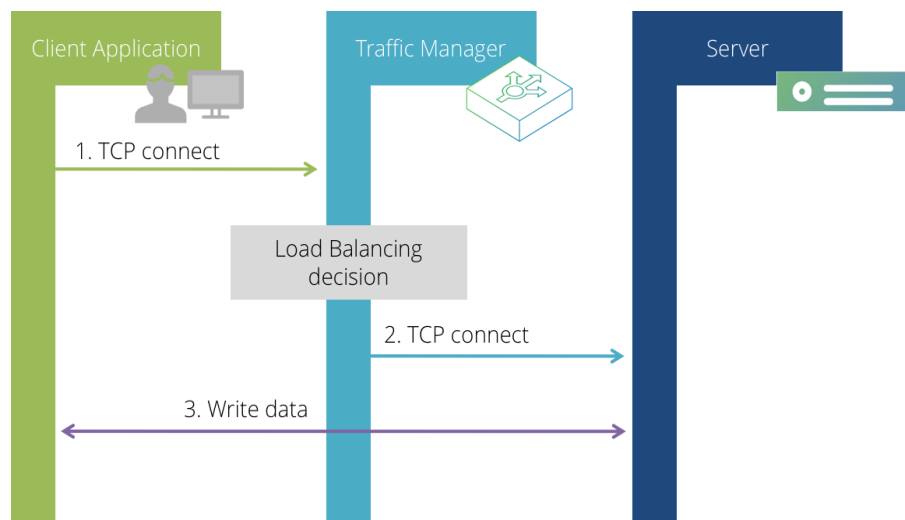

This option is for protocols where there is no request-response semantic. Either side of the connection can write the first message, with no response being necessarily required or expected. TrafficScript request rules are run whenever the client writes data on the connection, and similarly response rules are run every time the server writes data on the connection.

HTTP

The Traffic Manager's HTTP virtual server protocol type contains a number of optimizations and specializations for HTTP traffic:

- The Traffic Manager manages client-side and server-side connections independently, re-using keepalive connections on the server side whenever possible to reduce the number of established and new TCP connections to the server. This minimizes the number of concurrent connections the servers need to handle, and brings big performance and capacity gains.

Note that features such as HTTP POSTs and missing content lengths can make keepalives unsafe to use; the Traffic Manager detects when this occurs and creates new connections appropriately. NTLM authentication specifically requires that keepalives are enabled.

- The Traffic Manager conceals the use of keepalives and pipelining from the administrator, so that traffic management rules need only concentrate on the simple request-response nature of an HTTP transaction. Every HTTP transaction is processed and handled independently, regardless of whether or not it is in a keepalive connection.
- The Traffic Manager automatically handles HTTP encodings, such as gzip and deflate content compression and chunked transfer encoding. For example, if you inspect an HTTP response using the `http.getResponseBody()` TrafficScript function or from within a Java Extension, the Traffic Manager will automatically de-chunk and uncompress the response so that it can be easily manipulated.
- The Traffic Manager includes a large set of specialized HTTP TrafficScript functions that make it easy to process HTTP requests and responses. For example, functions are provided to manipulate HTTP cookies, read HTTP headers (such as the host header) and process URLs without having to understand the underlying encodings, variations in format and protocol details that complicate these tasks.

The Traffic Manager additionally offers client-side support for the HTTP/2 protocol (see RFC7540 and RFC7541). HTTP/2 is intended as a replacement for HTTP/1.x and is designed to improve page-load times over high latency connections, most notably by supporting transaction multiplexing over a single TCP connection.

The Traffic Manager supports HTTP/2 with the following considerations:

- Some browsers do not support HTTP/2 over an unencrypted connection. To maximize the number of users who can access the service using HTTP/2, Ivanti recommends that you enable the Traffic Manager's SSL decryption feature for your applicable virtual servers.
- HTTP/2 over a secure connection requires TLS 1.2 or later, the `SSL_ECDHE_RSA_WITH_AES_128_GCM_SHA256` cipher, the P256 elliptic curve, and does not support renegotiation after connection establishment. These options are enabled by default, but might have been disabled after upgrading your Traffic Manager from an older release. Clients using an obsolete cipher or older TLS version can only send HTTP/1.x requests when connecting to a virtual server with HTTP/2 enabled.
- The Traffic Manager does not support Pulse Secure Web Accelerator content optimization on HTTP/2 transactions.

- The Traffic Manager translates HTTP/2 data received from a client to HTTP/1.1 before processing it and forwarding it to the virtual server's pool nodes. This ensures that you can continue to use HTTP/2 functionality in the Traffic Manager without your back-end nodes being required to support HTTP/2 themselves.
- TrafficScript functions work transparently with HTTP/2 connections. Note that:
 - To determine the HTTP version the client connection is using, use the TrafficScript function `http.getClientVersionNumber()`.
 - Ivanti recommends exercising caution when using `connection.discard()` with HTTP virtual servers. HTTP/2 allows transactions to be multiplexed over a single connection, so discarding a connection interrupts all of its ongoing transactions.
 - The TrafficScript function `connection.close()` is deprecated for all HTTP/1.x and HTTP/2 services. Ivanti recommends modifying any applicable TrafficScript rules that use this function to use instead `http.sendResponse()` and `http.discardClientKeepalive()`. For further information, see the *Pulse Secure Virtual Traffic Manager: TrafficScript Guide* available from the Ivanti Web site (www.ivanti.com).

To inspect which HTTP version clients are using, view either "Request Tracing" or "Request Details" when selecting a connection under **Activity > Connections**. Additionally, use the %r or %H logging macros to report on HTTP/2 usage, or refer to the SNMP counter "virtualserverTotalHTTP2Requests" which is incremented for every HTTP/2 request.

SSL

When you configure the Traffic Manager to manage traffic using the SSL protocol, the Traffic Manager does not automatically decrypt the traffic. The SSL protocol type is used for SSL pass-through, without modification.

You can use the "SSL Session ID" persistence type to load-balance SSL connections across a pool, ensuring that connections with the same SSL session ID are sent to the same back-end server. This is an important consideration because SSL servers do not generally share SSL session IDs with each other. So if a client attempts to re-use an SSL session ID, but is directed to a new server, it would then need to renegotiate its SSL session. This is compute-expensive and will add load to your SSL server farm. In fact, without SSL session ID persistence, adding more SSL servers to your cluster can reduce performance because SSL sessions need to be renegotiated more frequently.



If you want to decrypt SSL traffic and process it using the internal protocol (such as HTTP), you should configure your virtual server to use the internal protocol, and enable SSL decryption in the virtual server configuration settings (for details about configuring SSL, see [SSL Decryption](#) and [SSL Encryption](#)).

Protecting the SSL Handshake

To protect against a potential Denial-of-Service (DoS) attacks, place a limit on the size of the peer handshake message clients attempt when negotiating an SSL connection. Use the **ssl!max_handshake_message_size** setting in **System > Global Settings > SSL Configuration**.

The value of this setting determines the maximum size of SSL handshake messages accepted for SSL connections. Any handshake message indicating a size larger than this setting will cause the SSL connection to fail and will be logged as a potential DoS attack in the event log. The default value of 10 KiB should be able to accept a chain of 5 certificates, which should be more than sufficient for typical SSL set-ups. Specifying a value of 0 (zero) denotes that there is no limit to the size of SSL handshake messages handled by the Traffic Manager.

SSL Connection Renegotiation Protection

Both SSL 3.0 and TLS (Transport Layer Security) protocols allow either the client or server to initiate renegotiation of the secure connection. This might be to establish new cryptographic parameters by which the connection will be governed.

During renegotiation, the secure connection becomes potentially vulnerable to interception by an attacker who might seek to inject traffic as a prefix to the client's interaction with the server. This mechanism, known as a Man-in-the-Middle (MitM) attack, can be used to set up a new client connection from the attacker, fooling the target server into believing that the initial data transmitted by the attacker is from the same entity as the original client.

Furthermore, renegotiation can be used to carry out a Denial of Service (DoS) attack because it poses a much higher load on the server than on the client. A client could simply request a re-handshake at a very high rate causing a very high computational burden on the server.

RFC-5746 (<http://tools.ietf.org/html/rfc5746>) introduces a TLS extension that prevents the MitM attack by cryptographically tying renegotiations to the client that is performing it. However, the introduction of this extension does not necessarily prevent or protect from a DoS attack.

The RFC-5746 renegotiation indication extension was found to be vulnerable to the Triple Handshake Attack, described in RFC-7627 (<http://tools.ietf.org/html/rfc7627>). That RFC also introduces another TLS extension to defend against this attack by the use of an "extended master secret" for TLS versions 1.0 - 1.2.

To configure how the Traffic Manager handles a potential renegotiation handshake, select the required setting in **ssl!allow_rehandshake**, located in **System > Global Settings > SSL Configuration**. The available options are:

| Setting | Description |
|---|---|
| Always allow | Renegotiation is always allowed, even if the client lacks support for RFC-5746 or RFC 7627, but without any form of protection against intervention by a third party. This setting is NOT RECOMMENDED, and could leave your system open to MitM or DoS attacks. |
| Allow safe re-handshakes [default setting] | This includes the case in which the client supports RFC-5746 and the case that no data has yet been transmitted over the connection. Since the aforementioned attack consists of pre-pending plain text, if no data has yet been received, the re-handshake is safe. This is of limited use as from the client's perspective, the re-handshake is actually the first handshake, so the client cannot know whether the connection is under attack. This option is therefore mostly provided for backward compatibility with clients that have yet to be upgraded to support RFC-5746. Renegotiation is also prevented following the resumption of a session that was not originally created during a handshake using the extended master secret extension. Note that since this setting allows re-handshakes it still leaves an installation potentially open to the DoS attack mentioned above. |
| Only if client uses RFC 5746 (Secure Renegotiation Extension) | Renegotiation handshakes are only allowed if the client supports Secure Renegotiation as defined in RFC-5746. Renegotiation is prevented following the resumption of a session that was not originally created during a handshake using the RFC 7627 extended master secret extension. Note that since this setting allows re-handshakes it still leaves an installation potentially open to the DoS attack mentioned above. |

| Setting | Description |
|-------------|---|
| Never allow | Reject all attempts at a renegotiation handshake. This is the most secure method as it protects against both MitM and DoS attacks. However, service failure is possible if, for example, some aspect of your installation depends on client-side renegotiation. |

If SSL 3.0/TLS re-handshakes are allowed, you can use the **ssl!min_rehandshake_interval** setting to define the minimum time interval (in milliseconds) permitted between handshakes on a single SSL 3.0/TLS connection. The time interval starts when the opening handshake is initiated and is reset at the beginning of every re-handshake. To disable the minimum interval for handshakes, use a setting of 0 (zero).

If the Traffic Manager acts as an SSL server (**ssl_decrypt** is set to "Yes" in a virtual server) and a renegotiation is triggered by the Traffic Manager itself via the TrafficScript function `ssl.requirecert()`, the resulting renegotiation will not be subject to the rate limit.

SMTP (Simple Mail Transport Protocol)

SMTP is a server-first protocol, with one additional capability. For improved security, an SSL client can request that an SMTP connection is encrypted using SSL (also known as TLS).

If you configure a virtual server to use the SMTP protocol, it behaves like a regular Generic Server First protocol (for further information, see [Server-First Protocols](#)). Ivanti recommends you configure your virtual server with a server first banner. For further information, see [Server-First with "Server Banner"](#).

Note that if you enable SSL for an SMTP virtual server, the Traffic Manager provides an additional setting named **smtp!expect_starttls** on the **Virtual Server > Edit > SSL** page. Configure this setting as follows:

- **No:** The virtual server decrypts SSL traffic in the normal way. In other words, expect traffic to be SSL-encrypted at the very beginning of the connections.
- **Yes:** The Traffic Manager processes traffic in plain text, as if it were unencrypted. The Traffic Manager watches for a "STARTTLS" SMTP command from the client and then initiates an SSL handshake to upgrade the client's connection to SSL.

The Traffic Manager forwards all traffic to the back-end SMTP servers unencrypted (in plaintext) unless you enable SSL encryption in the pool configuration. If you enable SSL encryption, the Traffic Manager encrypts the connection from the outset, rather than using the STARTTLS SMTP command.

FTP

The FTP protocol is used to transfer files from client to server. An FTP session consists of:

- A control connection, initiated by the client to port 21 (typically) on the remote server; this connection is received and proxied by the Traffic Manager.
- One or more data connections that are created on-the-fly as a result of commands sent down the control connection; these connections may be initiated by the server to the client ("active mode") or by the client to the server ("passive mode").

The Traffic Manager's 'FTP' virtual server type includes a full FTP proxy that intercepts and manages the requests to create additional data connections. The Traffic Manager proxies the data connections just as it proxies the control connection, supporting both the active and passive modes of data transfer.

The proxy fully supports all commonly used FTP data connection commands, including the long (RFC 1639) and extended (RFC 2428) versions. The proxy does not support the RFC 4217 encryption control statements ("AUTH TLS", "AUTH SSL", "CCC"), and removes these commands from the control stream.



Consider source port should not be used with any Traffic IP Addresses that are used by FTP virtual servers (see the [Creating a Traffic IP Group](#)).

FTP Security

FTP is not a secure protocol. Passwords are not used for "anonymous" file transfers which are common across the public Internet, but where passwords are needed, they are sent in plain text and vulnerable to eavesdropping. If this is of concern, alternative protocols such as SCP, WebDAV or SSL-wrapped FTP (see the SSL-Wrapped FTP section of this chapter) must be used.

A second concern is the ease with which an eavesdropper can snoop on the dialog that prepares the client and server for a data connection, and can then step in and initiate the connection to the listening party.

For example, when an Active FTP connection is set up, the client informs the server of the local client port that the server should connect to in order to establish the data connection. An eavesdropper could step in and connect to the client's local port before the server does, and then capture any data the client sends (or return a fake file to the client).

The FTP protocol does not have any built-in security measures to authenticate connections and to prevent this from happening, but many modern FTP clients and servers will check the source IP address of incoming connections to verify that they originate from the remote FTP agent they are communicating with. This behavior is enabled by default in the Traffic Manager – click **Virtual Server > Edit > Protocol Settings** and examine the settings in the “FTP-Specific Settings” section of that page:

| Setting | Description |
|-------------------------|---|
| ftp_force_client_secure | Verify that all passive data connections originate from the client’s IP address. Default: “yes”. |
| ftp_force_server_secure | Verify that all active data connections originate from the server’s IP address. Default: “yes”. |
| port_range | Specify the range of destination ports used for data connections; these ports might need to be permitted through intervening firewalls so that, for example, clients can make passive connections to the Traffic Manager. |

FTP Source Ports

The FTP specification recommends that FTP server data connections should use a source port one below the FTP service port. The typical FTP service port is port 21, so the data source port is recommended to be port 20.

In practice, the vast majority of FTP clients and servers ignore this recommendation because it has security implications and does not provide any additional assurance or authentication. By default, the Traffic Manager will select high port numbers on a random basis for FTP data connections that originate from the Traffic Manager.

Specifying the Source Port

To specify a source port that a virtual server must use, use **ftp_data_source_port** (in **Virtual Server > Edit > Protocol Settings > FTP Settings**). This is often required when an upstream firewall is used to block outgoing connections, other than those permitted with an explicit policy (for example, source port and IP).

FTP software in a Unix/Linux environment requires certain permissions to issue requests from low ports (lower than 1024), such as port 20. By default, the Traffic Manager drops these permissions early (principle of least privilege), so attempts to configure **ftp_data_source_port** to a low value will fail. If you wish to use low ports, enable the setting **ftp_bind_data_low** in **System > Global Setting > System Settings**; this will cause the Traffic Manager relinquish fewer permissions so that it retains the ability to bind to low ports.

On modern Linux platforms only the privilege to bind to low ports is kept, while on UNIX variants full root privileges is retained.

SSL-Wrapped FTP (FTPS)

The Traffic Manager supports the pre-RFC 4217 use of FTPS (referred to as "Implicit FTPS" or "SSL-wrapped FTP"). In this implementation, the control port is encrypted from the very beginning; the data connections are generally encrypted but can operate in plain text if desired.

The virtual server protocol type for SSL-wrapped FTP is "FTP"; the virtual server and pool can be independently configured to decrypt or encrypt the control channel communications.

Controlling the Control Channel

Use the following settings:

- **ssl_decrypt (Virtual Server > Edit > SSL Decryption)**: Enables SSL decryption for client-side connections. For more information on configuring SSL decryption, see [Setting Up SSL Decryption](#).
- **ssl_encrypt (Pool > Edit > SSL Settings)**: Enables encryption of the control connection before the Traffic Manager sends it to a back-end server. For more information, see [SSL Encryption](#).

The Traffic Manager's FTP proxy disables the encryption control statements ("AUTH TLS", "AUTH SSL", "CCC") in RFC 4217 so that they cannot interfere with the established SSL-wrapped FTP session.

Controlling the Data Channel

The Traffic Manager can decrypt the data channel or leave it unmodified: this behavior is controlled by the **Virtual Server > SSL Decryption** setting **ftp!ssl_data**.

- If enabled, **ftp!ssl_data** will cause the virtual server to decrypt all data connections using the same public certificate as is used for the control port. Note that the FTP virtual server must also be configured to decrypt SSL with **ssl_decrypt**.

- If disabled, the virtual server will pass all data through unmodified. If the back-end server wishes to use SSL on the data connection, the client can negotiate directly with the back-end server, with the Traffic Manager as an intermediate proxy.

Note that on the server side, the Traffic Manager will encrypt the data connection if either:

- The virtual server setting **ssl_decrypt** is disabled (the virtual server is not decrypting SSL), and the pool setting **ssl_encrypt** is enabled (the pool is encrypting the server-side of the data channel). In this case, data communications with the clients will be in plain text.
- The virtual server settings **ssl_decrypt** and **ftp!ssl_data** are both enabled (the virtual server is decrypting SSL), and the pool setting **ssl_encrypt** is enabled (the pool is encrypting the server-side of the data channel). In this case, data communications with the clients will be encrypted.

Use Cases for SSL-Wrapped FTP

Use Case 1: Servers and Clients Support SSL-Wrapped FTP

In this use case, all parties support and use SSL-wrapped FTP and the Traffic Manager acts as a load-balancing proxy, connecting clients to servers. The Traffic Manager decrypts and re-encrypts the control connection internally so that it can be inspected, and the Traffic Manager can optionally decrypt and re-encrypt the data connection.

- Enable SSL decryption (virtual server: **ssl_decrypt**) and SSL encryption (pool: **ssl_encrypt**) so that the Traffic Manager can inspect and proxy the control channel, and create data connections dynamically.
- Optional: enable **ftp!ssl_data**. If disabled, clients and servers can negotiate whether or not to use encryption on the data connections. If enabled, the Traffic Manager will require clients to use SSL for data transfers.



Enabling **ftp!ssl_data** brings two benefits: First, certificate management is easier as all connections are encrypted and authenticated against the Traffic Manager virtual server certificate. Second, the Traffic Manager will force all clients to use SSL for their data connections.

Without **ftp!ssl_data**, you would need to synchronize certificates across the Traffic Manager and the back-end servers, and you could not prevent clients and servers from using plain text (unencrypted) data connections. However, these benefits come at the cost of additional SSL processing on the Traffic Manager system.

Use Case 2: Clients Support SSL-Wrapped FTP; Servers Do Not

This configuration can be used with FTP servers that do not support SSL or in situations where the Traffic Manager and FTP servers are in close proximity and there is no need to secure the network connections between them:

- Enable SSL decryption (virtual server: **ssl_decrypt**), but do not enable SSL encryption (pool: **ssl_encrypt**). The Traffic Manager will decrypt SSL-wrapped FTP from the client, and pass it in plain-text to the FTP servers in the pool.
- Recommended: enable **ftp!ssl_data**. If disabled, clients and servers will always use plain text (unencrypted) connections for data transfer. If enabled, the Traffic Manager will force clients to use SSL for data transfers.

This use case illustrates an easy way to upgrade your FTP services to SSL-wrapped FTP without requiring any server modifications.

Real-Time Streaming Protocol

The Real-Time Streaming Protocol (RTSP) allows a client to establish and control either a single or several time-synchronized streams of continuous media, such as audio and video servers. Applications based on RTSP act as a video-like remote control panel for multimedia servers. Some servers also use the Session Initiation Protocol (SIP) combined with RTSP in the same conference.

RTSP is used by client applications such as QuickTime, MPlayer, VLC, Windows Media Player and RealPlayer.

The Traffic Manager is able to recognize and manage RTSP traffic, allowing users to load balance a pool of media servers that handle this type of traffic.

The figure below shows the usual layout of a RTSP connection. An RTSP client will establish a TCP connection to an RTSP server, via the Traffic Manager, over which RTSP requests will be issued. This is the control channel. The media data itself may be sent independently over UDP (the most common scenario), or multiplexed over TCP using the same connection.

Alternatively HTTP may also be used for data delivery. Note that the client and server negotiate during the setup if the underlying transport protocol to be used is UDP or TCP; this configuration is not done from the Traffic Manager.

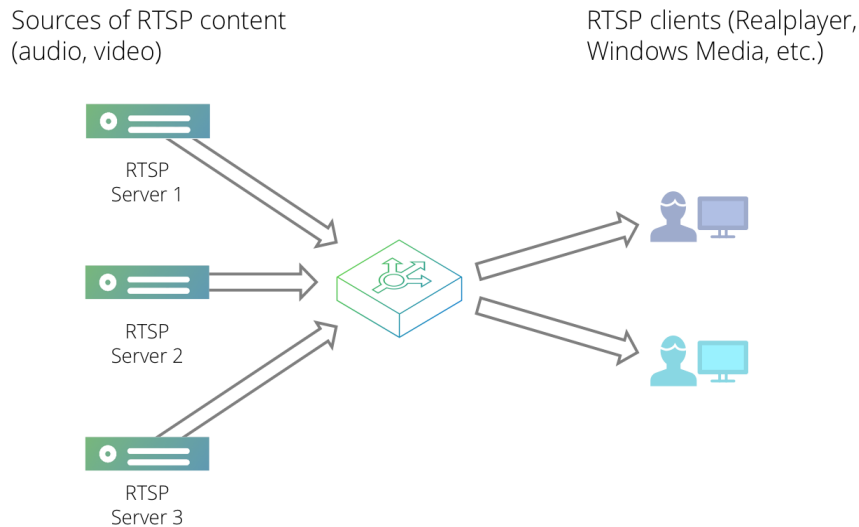

RTSP itself only controls the transport of the media. The protocols involved in a full media transaction can include the following:

- **RTP**: Real-time Transport Protocol, used to transport the data.
- **RTCP**: Real Time Control Protocol, used to provide extra information for an RTP stream.
- **RD**: Real Data Transport, a proprietary data delivery format from Real Networks that transports the data stream.

From a functional point of view, the use of a Traffic Manager for the handling of RTSP:

- Reduces the stress on the servers and allows load balancing across a pool of RTSP servers.
- Customizes and improves the performance, by using TrafficScript rules.
- Provides session persistence in the case of a server failure.

Setting Up an RTSP Service

RTSP runs over port 554 by default. To manage an RTSP service with the Traffic Manager, create a virtual server listening on port 554 (or an alternative port if appropriate), and select the protocol type "RTSP".

Your virtual server will need to use additional ports to stream content over UDP. To specify a range of ports, use the **Protocol Settings** page for the RTSP virtual server. In the "RTSP-Specific Settings" section you can modify the port range. Ivanti recommends that you enter the largest range possible.

Protocol Settings

Virtual Server: RTSP Service (RTSP, port 554) Unfold All / Fold All

Settings controlling how the virtual server communicates with the remote client.

▼ **RTSP-Specific Settings**

How the virtual server handles RTSP traffic.

If non-zero data-streams associated with RTSP connections will timeout if no data is transmitted for this many seconds.

rtsp_streaming_timeout: seconds

The virtual server needs to bind to additional ports for UDP streams between the client and server to allow streaming data delivery. You may need to allow these ports through your firewall.

Specify a port range: Yes No

Lowest port: Highest port:

The total number of ports needed depends on the transport method and specific servers used, the specific player used by the clients and the format of the files to be streamed. For example, in a system with 100 active clients, up to 8 ports per client might be needed, giving us a total number of 800 ports.

Session Initiation Protocol

Session Initiation Protocol (SIP) is an application-layer control protocol that can initiate, control, modify or terminate sessions with one or more participants. SIP is typically used for telephone and video calls, streaming multimedia distribution and conferencing. The SIP protocol offers the following features:

- User location
- User availability
- User capabilities
- Session setup
- Session management

Features of SIP

This section outlines the features of SIP in more detail.

- **User Location:** When a user activates a SIP device (for example, a SIP phone), it registers its current location with a SIP server. The user can then be contacted at the server's domain. Each user can have several devices in different locations registered with a server at the same time.

When someone attempts to contact the user, the message will arrive at the server. The server will then choose one or several of the user's registered locations to forward the message to.

- **User Availability:** When a SIP device receives a message it can respond in several different ways. The response might be determined by user input – for example the user answering an incoming call. Alternatively, the response might be automatically generated, for example if the device is already in use a “Busy” response might be returned. The server will decide what to do with this response - it might send it back to the caller or it might try sending the original message to a different location.

If the user has no devices registered with the server then they are considered to be unavailable.

- **User Capabilities:** SIP devices are able to query other SIP devices to learn what capabilities they have. Communication can then take place using the features that both devices support.
- **Session Setup:** SIP can be used with the Session Description Protocol to establish a direct communication channel between two devices. This communication channel is then used to transmit session data, such as voice data in the case of a telephone call, while the SIP channel is used to send control information, such as a request to disconnect the call. Session data is typically transmitted using the Real-Time Transport Protocol (RTP).
- **Session management:** SIP controls termination of sessions and transfer of sessions between different devices. It is also possible to change the parameters of an established session using SIP.

SIP supports both IPv4 and IPv6, and operates over TCP and UDP.

The Traffic Manager and the SIP Protocol

The Traffic Manager load-balances SIP traffic between SIP proxy servers, creating a SIP infrastructure with high availability, reliability and extensibility. The figure below shows an example of a SIP network that includes a Traffic Manager. The SIP phones are typically located at the users' individual locations, while the Traffic Manager, the SIP proxy servers and the location database are owned by a SIP service provider.

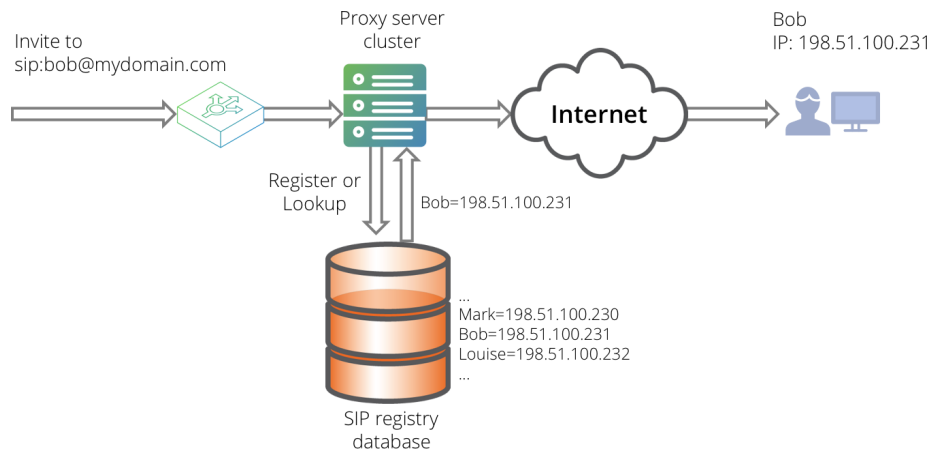

When working with SIP traffic, the Traffic Manager provides the following features:

- Load-balance SIP requests between SIP proxy servers with customizable load-balancing algorithms.
- Maintain session persistence so all requests that are part of the same session will be sent to the same proxy server (by default, the Traffic Manager persists on the SIP "Call-ID" header).
- Modify SIP request and response packets as they pass through the Traffic Manager using RuleBuilder and TrafficScript rules.
- Issue responses to incoming requests without sending them to a proxy server.
- Monitor the health of the proxy servers in use and direct traffic away from them when they go down.
- Act as a gateway for all SIP data and session data when all clients are in a private network.
- Protect against Denial of Service attacks and malicious data.

Configuring the Proxy Servers to Support Traffic Management

The Traffic Manager is most effective when used in front of a series of SIP proxy servers, such as Oracle/Weblogic SIP server or SIP Express Router (SER). To work in this configuration, the proxy servers must recognize the domain clients use to contact the Traffic Manager as one they are responsible for. For example, if sip:user@example.com resolves to the IP of the Traffic Manager, then the proxy servers must be responsible for the domain example.com. The proxy server will then process the request instead of forwarding it to that domain, which would result in the request looping between the Traffic Manager and the proxy server.

Alternatively, if your proxy servers do not support domains, go to the **Virtual Servers > Edit > Protocol Settings** page of the Admin UI and enable the **rewrite_request_uri** option. Enabling this option will tell the Traffic Manager to replace the URI in each request it receives with the URI of the proxy server it sends the request to.

Setting Up a SIP Service on the Traffic Manager

To create a new SIP service, use the **Manage a new service** wizard. Specify a suitable name for the service, and choose either the SIP over TCP protocol or the SIP over UDP protocol. The default SIP port is 5060 for both TCP and UDP services. This wizard will set up a new SIP virtual server and pool with the details provided.

For your SIP virtual server to operate correctly, it must listen to all the IP addresses used to send or receive a SIP request. To do this, navigate to the **Virtual Servers > Edit > Basic Settings** page and locate the **Listening on** setting. Ensure that "All IP addresses" is selected (this is the default).

You can also use both the UDP and the TCP protocols on the same port by creating two virtual servers and assigning one of the protocols to each virtual server.

ATTENTION

When using the Traffic Manager in a SIP infrastructure, SIP requests are sent to the client on a different connection to the one used when they register with a SIP proxy server. As a result, the client's firewall must be configured to allow SIP requests through to the phone. Some firewalls will do this automatically, whereas others will need to be configured to forward requests on port 5060 to the user's phone.

SIP Operation Modes on the Traffic Manager

A SIP virtual server can run in three different operational modes: "SIP Routing", "SIP Gateway", and "Full Gateway". This setting affects how much involvement the Traffic Manager has over control information (SIP messages) and session data (typically RTP data in voice and video communication).

To define the SIP operational mode, edit your virtual server SIP settings in the Traffic Manager admin interface by clicking **Virtual Servers > Edit > Protocol Settings > SIP-specific settings**.

▼ SIP-Specific Settings

How the virtual server handles general SIP traffic.

The virtual server should discard a SIP transaction when no further messages have been seen within this time.

sip_transaction_timeout: seconds

When timing out a SIP transaction, send a 'timed out' response to the client and, in the case of an INVITE transaction, a CANCEL request to the server.

sip_timeout_messages: Yes No

The mode that this SIP virtual server should operate in.

sip_mode: SIP Routing
 SIP Gateway
 Full Gateway ...

Replace the Request-URI of SIP requests with the address of the selected back-end node.

sip_rewrite_uri: Yes No

Should the virtual server follow routing information contained in SIP requests. If set to **no**, requests will be routed to the chosen back-end node regardless of their URI or Route header.

sip_follow_route: Yes No

The action to take when a SIP request with body data arrives that should be routed to an external IP.

sip_dangerous_requests: Send the request to a back-end node
 Send a 403 Forbidden response to the client
 Forward the request to its target URI (dangerous)

SIP clients can have several pending requests at one time. To protect the traffic manager against DoS attacks, this setting limits the amount of memory each client can use. When the limit is reached new requests will be sent a 413 response. If the value is set to 0 (zero) the memory limit is disabled.

sip_max_connection_mem: bytes

The different modes of operation are described below:

- **SIP Routing:** Select this option to load-balance SIP sessions between your SIP proxy servers. The first SIP request and all responses to it will pass through the Traffic Manager and can be inspected and manipulated by RuleBuilder and TrafficScript rules.

The Traffic Manager will not add a Record-Route header field to the request. As a result, future requests that are part of the same session will not pass through the Traffic Manager but will instead go straight to the server that the original request was sent to.

In a typical SIP session, this means the INVITE request and all responses to it will pass through the Traffic Manager. Any subsequent requests that manage this session, such as BYE requests, will not pass through the Traffic Manager.

- **SIP Gateway:** Select this option to inspect every SIP request that is part of a session. When a request passes through the Traffic Manager, the Traffic Manager will add a Record-Route header field to it so that future requests that are part of this session will be routed through the Traffic Manager. All of these requests and the corresponding responses can be manipulated with RuleBuilder and TrafficScript rules.

In a typical SIP session, all the control messages such as INVITE and BYE will pass through the Traffic Manager, but the session data itself will not. This is the default mode of operation for SIP virtual servers in the Traffic Manager.

- **Full Gateway:** Select this option to make all session data pass through the Traffic Manager. This mode is useful if all your SIP clients are on the same network as your Traffic Manager and the Traffic Manager is acting as a gateway to the Internet.

In this mode, all control messages such as INVITE and BYE will pass through the Traffic Manager. The Traffic Manager will modify any Session Description Protocol information contained in the body data of a request or response so that the session data also passes through the Traffic Manager.

You can choose to specify a port range that will be used for the session data. You can also specify how long the Traffic Manager will wait before closing the session data connection when no data is being sent over it.

Additional SIP Settings

The Protocol Settings page also offers some additional settings that affect the behavior of the Traffic Manager. These settings are:

| Setting | Description |
|-------------------------|---|
| sip_transaction_timeout | SIP requests and responses are grouped into transactions. There are two types of transactions in SIP: INVITE transactions and Non-INVITE transactions. An INVITE transaction consists of an INVITE request, followed by a series of responses. If the final response was not a '200 OK' response then it is followed by an ACK request. A Non-INVITE transaction consists of a request followed by zero or more responses. A client can send several different transactions over the same connection. |

| Setting | Description |
|------------------|--|
| | <p>When no further messages that are part of a particular transaction have been seen for the time specified in sip_transaction_timeout, the Traffic Manager will reclaim the resources associated with the transaction.</p> <p>If the transaction is not complete when it times out, the Traffic Manager will issue a 408 request timeout response to the client.</p> |
| sip_rewrite_uri | <p>If set, this option tells the Traffic Manager to replace the URI of incoming requests with that of the back-end node the Traffic Manager has selected. For example, if a request arrives with the URI "sip:bob@example.com" and the Traffic Manager is responsible for the domain example.com, then the request that is sent to the back-end node will be sip:bob@192.0.2.1:5070 if the back-end node's IP is 192.0.2.1 and its SIP server is running on port 5070.</p> <p>This setting is useful if your SIP proxies do not check the domain of the user when looking up their location.</p> |
| sip_follow_route | <p>If set, this option tells the Traffic Manager to follow the routing information contained within incoming requests. If there is a Route header the request will be sent to the corresponding destination. If there is no Route header, the request will be sent to the destination specified by the URI. If the URI points to the Traffic Manager then the request will be sent to the pool as normal.</p> <p>This behavior can be overridden by the sip_dangerous_requests setting. For example, if a request arrives that contains body data and a Route header, the Route will be ignored and the request sent to the pool if sip_dangerous_requests is set to send dangerous requests to a back-end node.</p> <p>If sip_follow_route is set to No then all requests will be sent to the pool and will have a Route header added that corresponds to the chosen node.</p> |

| Setting | Description |
|------------------------|--|
| sip_dangerous_requests | <p>SIP requests contain their own routing information, and as such it is possible for them to be used to attack a remote computer through an intermediate machine. The Traffic Manager considers a request dangerous if its next destination is an external IP and the request contains body data.</p> <p>The Traffic Manager can handle potentially dangerous requests in several ways:</p> <p>It can send the request to a back-end node. This option is useful if your SIP proxy servers are responsible for domains that do not resolve to the Traffic Manager's IP. This is the default setting for potentially dangerous requests.</p> <p>It can send a 403 Forbidden response back to the client. This option is useful if you want to reject any requests that are not addressed to your Traffic Manager's domain.</p> <p>It can forward the request to its target URI. Selecting this option means SIP requests will be routed normally. Use this setting when you want your virtual server to handle outbound SIP traffic.</p> |
| sip_max_connection_mem | <p>A client can send multiple SIP requests on the same connection and receive responses to them in any order. To stop a client from having an excessive number of active requests awaiting a response, the Traffic Manager can limit the maximum amount of memory each connection can allocate.</p> <p>This setting specifies how much memory the Traffic Manager should allow each connection to use before refusing new requests with a "413 Request Entity Too Large" response. If this value is set to 0 then the memory limitations are removed, however this will leave the Traffic Manager more vulnerable to a Denial of Service attack.</p> |

UDP-based SIP services additionally use the following setting, found in "UDP-Specific Settings":

| Setting | Description |
|-----------------------------|--|
| sip_udp_associate_by_source | <p>Specifies whether all datagrams sent by the client in a SIP UDP transaction must be sent from the same IP address and port.</p> <p>The setting is enabled by default. If disabled, the IP address from which a datagram has been sent is not taken into account by the Traffic Manager when identifying the transaction to which a datagram belongs.</p> <p>The client IP address to which the Traffic Manager sends response datagrams remains unchanged, even if datagrams are received from an IP address different to that from which the first datagram in a transaction was received.</p> |

Communicating with UDP-Based SIP Servers

Typically, UDP-based SIP servers respond to requests much like TCP-based SIP servers – by sending the response from the same port on which they received the original request. This behavior is not explicitly required, however, and some SIP servers might respond from a different port or even from a different IP to the one on which it received the corresponding request.

The Traffic Manager caters for this behavior with a configuration setting **udp_accept_from** on the **Pools > Edit > Protocol Settings** page (where the pool is used by a UDP service). Use this setting to select how the Traffic Manager receives responses to UDP requests, from the following options:

- Only the IP address and port to which the request was sent.
- Only the IP address it was sent to but any port.
- A specific set of IP addresses but any port.
- Any IP address and any port.

If you choose to only accept responses from a specific set of IP addresses, type a CIDR Mask (such as 198.51.0.0/16) into the box provided.

These settings provide a varying degree of trade-off between security and compatibility. Allowing responses from multiple IP addresses can pose a greater security risk due to the increased possibility of fraudulent responses, yet certain SIP servers might require this functionality to communicate correctly. Select the option that most closely matches your requirements.

An associated setting is provided for SIP (over UDP) Health Monitors. For further details, see [Built-in Health Monitors](#).

To limit the maximum amount of time a server node is permitted to take after receiving a UDP request from a client, set **udp_response_time** to the required number of seconds. A value of "0" (the default) disables the timeout counter; meaning servers that do not send replies are not automatically marked as having failed.

ATTENTION

Requests sent to an IPv4 address expect a response back from an IPv4 address only. Conversely, requests sent to an IPv6 address allow a response back in either IPv4 or IPv6 form.

Proxy Protocol

Proxy Protocol is a connection-level protocol used for communicating the source and destination details of a TCP connection between proxies and other traffic routing/processing devices in the network.

Proxy Protocol enabled clients and servers add the original source and destination IP addresses and ports to a "PROXY" header in the request. This header remains unchanged irrespective of any modifications made to the connection by a proxy, such as the Traffic Manager, during its lifetime.

The Traffic Manager supports the use and processing of Proxy Protocol version 1 in your virtual servers, using plain text headers, on client side connections only.



You can add PROXY headers to server side connections through TrafficScript, although the Traffic Manager does not perform any processing on such connections.

To enable Proxy Protocol support for a virtual server, click **Services > Virtual Servers > Edit > Protocol Settings > TCP Connection Settings** and set **proxy_protocol** to "Yes".

Since PROXY header parsing is done on connection setup, the header contents are available through TrafficScript in a request rule (and at later stages). For information concerning the applicable TrafficScript functions, see the *Pulse Secure Virtual Traffic Manager: TrafficScript Guide*.

All connections handled by a Proxy Protocol enabled virtual server must have a valid PROXY header. If the header is missing or malformed, the connection is dropped. Alternatively, if your virtual server has client connection failure logging enabled, the Traffic Manager reports an error in the event log.

You can also record PROXY header data items in the request log, or observe the contents of the PROXY header on the **Activity > Connections** page in the Admin UI.

Session Persistence

This chapter explains how the Traffic Manager is used to provide persistent sessions (also known as sticky sessions) between clients and back-end servers.

What Is Session Persistence?

Many classes of requests from clients can be load-balanced across a pool of back-end servers. Multiple requests from one client can be shared across the back ends with no disruption to service. However, there are certain exceptions, such as server applications which depend upon storing information about a client locally, which may not readily be load-balanced in this way. These include:

- Web mail applications that track a user's login by storing files on disk.
- Shopping carts that store the contents of a client's cart on disk or in memory.
- Programs or protocols with a higher start-up time than normal (such as Java applications or SSL connections).

In these situations, the Traffic Manager can ensure that requests are mapped to the same back-end server for each request, for the duration of the client's session:

When the Traffic Manager receives a new connection, it uses its load balancing logic to choose a node for that connection. The Traffic Manager then records the chosen node in a session persistence map.

When another connection in the same session is received, the Traffic Manager uses the node that was chosen previously.

In this way, all connections in the same 'session' are pinned to the same back-end node. The session persistence class in use defines how a session is identified, and you can refine this decision using several TrafficScript methods.

Session persistence classes can be used to direct all requests in a client session to the same node. This may be necessary for complex applications, where an application session may be maintained over a number of separate connections. Examples of this include Web-based shopping carts, and many complex UDP-based protocols.

Session persistence should only be used when necessary. It effectively bypasses the load-balancing process for all but new sessions, so unless it is necessary to send all requests from the same client to the same back-end node, response times will be better without session persistence.

Configuring Session Persistence

Session persistence is configured via the Catalog. Session Persistence Classes are added to the catalog, and can then be assigned to a pool, or selected in a TrafficScript rule.

When TrafficScript is not being used, Session Persistence is enabled on a per-pool basis. You can define multiple pools, and enable session persistence only for those that require it. Note that a back-end server can be in more than one pool.

Several pools can refer to the same session persistence class to share session persistence mappings. For example, a pool containing some HTTP nodes (on port 80) and a pool containing the same nodes running HTTPS services (on port 443) can share the session persistence mappings for users to the services.

When TrafficScript is being used, Session persistence can be overridden with a TrafficScript command. The Traffic Manager will use the Session Persistence Class specified for the pool which handles the request unless this command is used.

Enabling Session Persistence

To view and edit Session Persistence classes, click **Catalogs > Persistence**. To create a new class, type a name in the box labeled "Create new Session Persistence class" and click **Create Class**.

The Admin UI now shows a summary of the settings for your new Session Persistence Class.

Name:

The type of session persistence to use.

type:

- IP-based persistence ...**
Send all requests from the same source address or subnet to the same node.
If the subnet prefix length is 0, requests from the same IPv4 or IPv6 source address will be sent to the same node.
If the subnet prefix length is specified, requests from the same IPv4 or IPv6 subnet, based on that prefix length, will be sent to the same node.
IPv4 subnet prefix length:
IPv6 subnet prefix length:
- Universal session persistence**
Use session persistence data supplied by a TrafficScript rule.
- Named Node session persistence**
Use a node specified by a TrafficScript rule.
- Transparent session affinity**
Insert cookies into the response to track sessions.
- Monitor application cookies ...**
Monitor a specified application cookie to identify sessions.
- J2EE session persistence**
Monitor Java's JSESSIONID cookie and URLs
- ASP and ASP.NET session persistence**
Monitor ASP session cookies and ASP.NET session cookies and cookieless URLs.
- X-Zeus-Backend cookies**
Inspect an application cookie named 'X-Zeus-Backend' which names the destination node.
- SSL Session ID persistence**
Use the SSL Session ID to identify sessions (SSL pass-through only).

The action the pool should take if the session data is invalid or it cannot contact the node specified by the session.

failuremode:

- Choose a new node to use
- Redirect the user to a given URL ...
- Close the connection (using error_file on Virtual Servers > Edit > Protocol Settings)

Whether or not the session should be deleted when a session failure occurs. (Note, setting a failure mode of 'choose a new node' implicitly deletes the session.)

delete: Yes No

A description of the session persistence class.

note:

Selecting a Persistence Method

By default, new Session Persistence Classes are configured with "IP-based Persistence" selected. The following alternatives are available when session persistence is required:

| Method | Applicable Protocols | Description |
|-------------------------------|----------------------|--|
| IP-based persistence | All | Send all requests originating from the same source IP address (or optional subnet range) to the same node. |
| Universal session persistence | All | This class allows you to persist sessions based on any information in a request by setting a unique persistence key in a TrafficScript rule. |

| Method | Applicable Protocols | Description |
|------------------------------|----------------------|--|
| Named Node persistence | All | With this method, a TrafficScript rule can direct the connection to a specific node. |
| Transparent session affinity | HTTP, HTTPS | Insert cookies into the response to track sessions. |
| Monitor application cookies | HTTP, HTTPS | Monitor a specified application cookie to identify sessions. |
| J2EE | HTTP, HTTPS | Monitor Java's JSESSIONID cookie and its URL-rewriting fallback. |
| ASP and ASP.net | HTTP, HTTPS | This method allows both types of ASP sessions to be processed using session persistence. |
| X-Zeus-Backend cookies | HTTP, HTTPS | Inspect an application cookie named "X-Zeus-Backend", which names the destination node. |
| SSL Session ID persistence | SSL protocols | Use the SSL Session ID to identify sessions. |

IP-Based Persistence

When IP-based persistence is selected, the Traffic Manager tracks and stores the originating IP address for each request to this pool. When the Traffic Manager receives further traffic from the same IP address, it uses the stored session map information to send requests to the back-end server node it used previously.

You can optionally specify an IPv4 or IPv6 subnet prefix length to ensure requests from the same IP subnet are sent to the same node. This can help to limit the size of the IP session maps maintained by your Traffic Manager cluster.

Some specialized mobile clients might change their IP address during a session, and some clients might share IP addresses (for example, through a proxy server), so this persistence type might not be suitable for some environments.

However, since IP-based persistence is completely transparent and is not protocol-dependent, it is useful for guaranteeing persistent connections for difficult protocols or applications.

IP session maps are shared by all Traffic Manager instances in a cluster. Requests received by different Traffic Managers are directed to the correct node, and if one Traffic Manager fails, the other Traffic Managers are aware of the IP session maps it was maintaining.

Universal Persistence

Universal session persistence uses a persistence key, defined in a TrafficScript rule, and seeks to direct all connections with the same persistence key to the same back-end node.

The persistence key is specified in a rule by the `connection.setPersistenceKey()` TrafficScript function. This allows persistent sessions based on any information in a request; see [Universal PHP Persistence](#) for an example.

Universal session persistence maps are shared by all Traffic Manager machines in a cluster. Requests received by different Traffic Manager machines will be directed to the correct node, and if one Traffic Manager fails, the other Traffic Managers are aware of the universal session maps it was maintaining.

ATTENTION

Note that when using Universal Session Persistence with the SIP protocol over UDP, session persistence will only be applied to the first request sent by a client. All subsequent requests from the same client will be sent to the same node as the first request, even if they have been assigned a different session persistence key. Universal Session Persistence should therefore be used with SIP only when you want all requests from the same client to be directed to the same server.

Named Node Persistence

Named Node session persistence can be used to direct the connection to a specific node in a pool. It gives very fine-grained control over how requests are routed.

A TrafficScript rule can use the `connection.setPersistenceNode()` function to specify precisely which node should be used in the session persistence decision. For example, when a new connection for a Remote Desktop service is received, a rule could query an external database to determine the node which hosts that user's desktop, and then use the `connection.setPersistenceNode()` function to direct the connection to that node.

Transparent Session Affinity

Transparent session affinity inserts cookies into the HTTP response to track sessions. This is generally the most appropriate method for HTTP and SSL-decrypted HTTPS traffic as it does not require the nodes to set any cookies in their response.

Transparent session maps are stored in a client-side cookie named "X-Mapping-xxxxxx", where "xxxxxx" is a unique identifier. All Traffic Managers in a cluster inspect the value of this session cookie and send the session to the same server node.

By default, the session cookie is inserted only if the corresponding request does not already contain a matching cookie. To force the Traffic Manager to insert the session cookie into every response sent to the client, enable "Set the cookie in every response". By including the session cookie with every response to the client, a TrafficScript response rule can then examine or modify the session cookie or any directives it might have.

To set HTTP cookie directives that the Traffic Manager should include with the session cookie, use the "Directives to include in the cookie" setting. For example, by adding the directive "Secure", most clients include the session cookie only with requests that are sent over a secure (HTTPS) connection. This allows a user to keep the use of the "X-Mapping-" session cookie out of sight from third parties who might see the contents of any insecure connection to the same destination.

To add more than one directive, use a semi-colon separator. For example, if both the "Secure" and "Max-Age" directives are used, specify the directive list as "Secure; Max-Age=3600".

Monitor Application Cookies

Application cookie persistence monitors a named cookie in the HTTP response from the node. For example, PHP applications may generate session cookies named "PHPSESSID" that the clustered PHP application could track and index session state. This persistence method directs a request to the same server node if it contains an application cookie. You need to specify the name of the application cookie you wish to monitor.

Application cookie session maps are stored in a client-side cookie "K-CookieName-xxxxxx", where "CookieName" is the name of the monitored cookie, "xxxxxx" is an opaque string that identifies the session persistence class, and the value of the cookie is an opaque string that identifies the preferred node. All Traffic Manager machines in a cluster will inspect the value of this session cookie and send the session to the same server node.

If the back-end server changes the value of the application cookie, the session is still valid and clients will continue to be directed to the same server node.

J2EE JSESSIONID Cookies/URL

J2EE JSESSIONID cookies/URL persistence monitors both the JSESSIONID cookie (as for application cookie persistence) and the jsessionid path parameter. These are defined in the Java extension specification (v2.4) and are used by Java extension containers such as BEA WebLogic, IBM WebSphere Application Server, JBoss/Tomcat and others.

J2EE session maps are shared by all Traffic Manager machines in a cluster, so requests received by different Traffic Manager machines will apply the same sessions.

ASP.net Session Persistence

ASP (Active Server Pages) is a server-side scripting protocol created by Microsoft to handle dynamically generated Web pages. In order to use ASP Session management in a server cluster, the same Web server must handle all requests coming from a user for the life of the session.

ASP sessions can use cookies or can be cookieless, depending on numerous factors, such as the lack of support of cookies by the browser or the user disabling them voluntarily.

- **For cookie-based sessions:** The Traffic Manager's ASP Session Persistence class detects and uses the cookie to identify the client's session.
- **For cookieless sessions:** The Traffic Manager's ASP Session Persistence class detects and uses the ASP identifier embedded in URLs generated by the ASP application.

ASP session maps are shared by all Traffic Manager machines in a cluster, so requests received by different Traffic Manager machines will apply the same sessions.

Note that if you have several distinct ASP applications hosted behind a single hostname, each application will generate its own cookie. You will need to have a separate ASP.Net session persistence class for each application so that mappings between cookies and nodes are managed independently for each application. For example, you may inspect the request URL to determine which application is being accessed and select the session persistence class using the TrafficScript function `connection.setPersistence()`.

X-Zeus-Backend Cookies

X-Zeus-Backend cookie persistence looks for a cookie named X-Zeus-Backend in each application request. If the cookie is present, and contains the name of a node in the current pool, the request is sent to that node. The cookie can be inserted either by a back-end server or by a TrafficScript rule.



This persistence method is deprecated, and provided only for backward compatibility with Zeus Load Balancer persistence cookies.

SSL Session ID Persistence (SSL Pass-Through Only)

The SSL session ID persistence method sends all SSL traffic with the same SSL session ID to the same server node. It is only applicable to SSL pass-through traffic, not SSL-decrypted traffic.



Connections using the TLSv1.3 protocol do not use session IDs for session resumption, therefore this method does not apply in that case.

SSL handshakes are expensive in terms of CPU time, network bandwidth, and latency. The SSL session ID persistence method reduces the number of SSL handshake operations your nodes perform by ensuring that a resumed connection is directed to the node that created (and stored) the session.

SSL Session ID session maps are shared by all Traffic Manager machines in a cluster. Requests received by different Traffic Manager machines will be directed to the correct node, and if one Traffic Manager fails, the other Traffic Managers are aware of the SSL Session ID session maps it was maintaining.

SSL session ID persistence is not appropriate for application-level session persistence because many SSL clients regularly renegotiate their SSL session ID. To achieve application-level session persistence you should either use IP-based session persistence, or decrypt the traffic and use universal session persistence or an HTTP method if applicable.

Resolving Session Persistence Maps to Nodes

When the Traffic Manager receives a new connection and there is no session persistence information, the Traffic Manager uses its load balancing logic to choose a node for that connection. The chosen node (IP address and port) is recorded in the session persistence mapping, which is either internal (in the case of IP, Universal or SSL session persistence) or in an external cookie (Transparent, Application cookie or X-Zeus-Backend cookie).

When another connection in that session is received and the Traffic Manager is ready to forward that connection to a node in a pool, the Traffic Manager inspects the session persistence class in use to determine if a particular node should be used.

If a node with the same IP address and port exists in the pool for the connection, then the Traffic Manager sends the connection to that node.

If there is not an exact match, the Traffic Manager searches the pool for any nodes with the same IP address (but different ports). If just one such node exists, the Traffic Manager sends the connection to that node.

This allows session persistence information to be shared between different pools with different nodes types.

For example, a Web-based application may use an HTTP interface to manage items in a shopping cart, and a secure HTTPS interface to manage payment. Session persistence requirements may dictate that users must be directed to the same physical machine for both HTTP and HTTPS traffic.

Both services (HTTP and HTTPS) could reference the same session persistence class. When a user first connects to the HTTP service, the Traffic Manager would use the HTTP pool. A session would be established with a particular node (IP address, port 80) in that pool.

When the user accesses the HTTPS service, the Traffic Manager might use a different pool containing HTTPS nodes. The session persistence class will then direct the request to the same physical machine (IP address, port 443) in the HTTPS pool.

Node Failure Options

Sometimes, the node required by the session persistence mapping might not be available. For example, it might be marked as “failed” by a monitor, or the Traffic Manager might be unable to connect to it.

The Traffic Manager provides alternative actions for sessions currently using that node. Use the **failuremode** setting to select one of the following actions:

| Action | Description |
|-------------------------------------|---|
| Choose a new node to use | The pool discards the session map and chooses a new node, using the current load-balancing algorithm. |
| Redirect the user to a given URL... | The pool sends an HTTP 302 redirect to the configured location (the URL setting) as a response to the request. The resource at the redirect location could display a message, or cause the user to log in again and establish a new session. |
| Close the connection | The pool immediately closes the connection. |

If you select “Redirect the user to a given URL...” or “Close the connection”, use the **delete** setting to choose whether to discard or retain the session map. If you set **delete** to “No” (to retain the session map), where the client returns and the session's node is available again, the Traffic Manager sends the request to the same node.

If you select “Choose a new node to use”, the Traffic Manager implicitly deletes the session map.

Draining Connections

Sometimes it is necessary to take a back-end server out of service; for example, to upgrade software, perform hardware maintenance or to decommission or repurpose it.

A pool's “Connection Draining” capability is designed to facilitate this. When you mark a node as “draining”, the Traffic Manager stops sending it any new connections. However, any connections that are in a session previously established to that node are still sent to that node.

This allows you to safely remove a node from a pool without interrupting either ongoing connections, or longer-term established sessions. Use the **Activity** section of the Admin UI to obtain details of how long a draining node has been idle, and then make a judgment as to whether all sessions have completed.

For example, suppose you have an e-commerce service and you use session persistence to tie individuals' sessions to particular back-end nodes. You mark one of your nodes as draining.

No new sessions are established with that node.

Existing, established sessions are allowed to continue with that node.

After 60 minutes, you inspect the **Activity > Draining Nodes** page in the Admin UI. You observe that the node has been idle for 35 minutes. It is most likely safe to conclude that all established sessions have now completed, and you can remove the node safely.

In practice, the time periods involved in determining whether a node has finished draining will be very much dependent on the application and user behavior. In setting up the system, an administrator will have to decide these values in relation to the desired use.

To learn more about how to configure connection draining, see [Draining, Disabling, or Removing a Node](#).

Configuring Session Persistence Caches

Some session persistence methods use client-side cookies to store the session persistence data. The remaining session persistence methods use caches in the Traffic Manager, shared automatically across a cluster, to store session persistence mapping.

For each persistence method that uses a cache, you can configure the maximum number of map entries each cache can hold. Additionally, for certain methods, you can configure the expiry time for each session map entry.

Setting an expiry time on cached session maps can help to redistribute load between pool nodes when new nodes are added, or when nodes recover from a failure. This is especially true in enterprise environments where the set of clients might be fixed. Configuring a session cache with a limited lifespan can also help when placing your nodes into a *draining* state. For further information on draining, see [Draining, Disabling, or Removing a Node](#).

The Traffic Manager does not actively delete cache entries when they reach the defined expiry time. Instead, the cache entry time is checked against the expiry value only when the entry is looked up. If the session is still current, the Traffic Manager returns the session and resets the cache entry time for that session mapping. If the session is deemed expired, the Traffic Manager deletes it from the cache and establishes a new session.



When a cache fills up faster than the Traffic Manager is able to remove expired session entries, the Traffic Manager discards the oldest (least recently used) entry when a new entry is added.

To configure persistence method caches, click **System > Global Settings > Cache Settings**. The following table shows the persistence class types, the corresponding cache size setting, and (if applicable) the corresponding expiry setting:

| Persistence Type | Cache Size Setting (number of entries) | Cache Expiry Setting (lifespan in seconds) |
|------------------------------------|---|---|
| IP session persistence | ip_cache_size | ip_cache_expiry |
| Universal session persistence | universal_cache_size | universal_cache_expiry |
| SSL session-id session persistence | ssl_cache_size | (not applicable) |
| J2EE session persistence | j2ee_cache_size | j2ee_cache_expiry |
| ASP session persistence | asp_cache_size | (not applicable) |

ATTENTION

Cache size and expiry settings are global - the value you set applies equally to all Session Persistence class instances you create for a particular persistence method.

To monitor the behavior of the caches, plot session persistence cache data values in the Activity Monitor. First, click **Activity** to use the Activity Monitor. Next, click **Change Data** and expand the **Cache Values** section in the "Values to monitor" tree. This section contains a sub-tree of persistence cache types. Select/expand the persistence type you want to monitor from the list, and tick the relevant data items to add to the graph. To plot the selected values, click **Apply**.

Key values to help you monitor and size the cache appropriately are shown in the following table:

| Setting | Description |
|------------|--|
| Entries | The number of entries in the cache |
| EntriesMax | The configured maximum size of the cache |
| Oldest | The time since the least recently used entry was last used |

After the Traffic Manager has processed a number of sessions, it is normal for the cache to completely fill up. The **Oldest** value indicates how long entries are retained without being used or expired out of the cache.

To help you size your cache, you need to consider the rate at which new entries are added to your cache (entries per second) and the length of time (in seconds) that you want these entries to be retained since they were last used. Multiply these two values together to get an estimate of the required cache size, and monitor the **Oldest** value to check that entries are not prematurely discarded because the cache has filled.

If you need fine-grained control of session persistence records, the most effective means is to use client-side cookies with specific expiry times, and tie the session persistence to the presence of the cookie.

Using Session Persistence with Multi-Hosted Traffic IP Addresses

If you use multi-hosted Traffic IP Addresses with the 'consider source port' setting enabled, then requests from one source IP address (i.e. from a client) will be handled by all of the Traffic Managers in your cluster (see [Creating a Traffic IP Group](#)).

In this situation, session persistence methods that rely on state sharing (session maps are shared between the Traffic Managers) may not work reliably. There is a short delay before session information is propagated across the cluster, and clients may visit several Traffic Managers during this period, resulting in corruption of the client's session persistence mapping.

Session persistence algorithms that depend on state sharing are:

- IP-based Session Persistence
- Universal Session Persistence
- SSL SessionID Session Persistence
- J2EE and ASP.NET Session Persistence

Do not use the **consider source port** setting in any multi-hosted Traffic IP addresses that are used by services that use any of the above session persistence methods.

Session Persistence with UDP protocols

UDP protocols are not connection oriented, but you will often desire that UDP datagrams in the same session are routed to the same back-end server.

In the **Virtual Servers > Edit > Protocol Settings** page, the two settings **udp_timeout** and **udp_response_datagrams_expected** are used to inform the Traffic Manager what the UDP session should look like.

The UDP session lasts until the number of response datagrams observed is equal to the setting **udp_response_datagrams_expected**. For example, if a session completes once the server has sent one datagram to the client, set **udp_response_datagrams_expected** to "1".

If the session is long-lived, set **udp_response_datagrams_expected** to "-1". The UDP session times out if no further UDP traffic has been observed within **udp_timeout** seconds.

You can use Session Persistence of various types (typically IP-based or Universal) with UDP if you want to track sessions for longer periods of time.

Examples

Universal PHP Persistence

A TrafficScript rule can inspect incoming HTTP requests, and select a back-end node based on the request.

The example in [Routing by Content Type](#) gives the TrafficScript rule to select a pool based on filename extension. This rule can be modified to pass session persistence data to a chosen Session Persistence Class.

Create a Session Persistence Classes called PHP, and set to use universal session persistence (see [Configuring Session Persistence](#)). Next create a TrafficScript rule in the catalog as follows:

```
$path = http.getPath();
if( string.endsWith( $path, ".php" )) {

    # Persist on the PHPSESSID cookie, IP address and
    # user agent
    $phpCookie = http.cookie( "PHPSESSID" ) .
        connection.getRemoteIP() .
        http.getHeader( "User-Agent" );

    # Set the persistence key to our unique value
    conection.setPersistenceKey( $phpCookie );

    # Select the PHP Session Persistence Class
    connection.setPersistence( "PHP" );
}
```

Apply this rule to the virtual server handling your traffic. The string passed to the pool.use() function (\$phpCookie) is the session persistence data used by the pool.

Requests for files with other extensions (such as .html or .jpg) are ignored by the above rule. These requests are passed on to the other rules used by the virtual server, or to its default Session Persistence Class as set in the default pool.

Also note that only one pool is required, and the Session Persistence is managed entirely by the two separate Session Persistence Classes.

SSL Encryption

This chapter explains how to use Secure Sockets Layer (SSL) encryption with the Traffic Manager. It includes a description of SSL and how to use the Traffic Manager to manage authentication and encryption, as well as the storage of certificates.



Version 3 of the SSL protocol was superseded by the Transport Layer Security (TLS) protocol versions 1.0, 1.1, 1.2, and 1.3. The Traffic Manager uses the term SSL throughout to refer generically to both SSL and TLS protocols, except where a particular SSL version is specified.

Overview of SSL

SSL is a protocol used to send traffic securely over the Internet. Traffic is encrypted using a key agreed between the server and client machines.

SSL provides several advantages:

- Server authentication
- Client authentication
- Encrypted data transfer

SSL can be used with almost any TCP/IP protocol, but is most commonly used to secure HTTP (Web) traffic, forming the HTTPS protocol.

Server Authentication

A server identifies itself for SSL communications using an “SSL certificate”. This certificate contains the name and location of the organization and its DNS name, and gives the client assurance that they are accessing the correct site.

An SSL certificate can be “self-signed” by the organization that owns it. However, without independent verification, the certificate is not automatically trusted by a client. To be trusted, the certificate must be signed by a recognized, independent Certificate Authority (CA) such as Symantec or Thawte. The organization sends a Certificate Signing Request (CSR) to the CA, which carries out thorough checks on the details in the certificate. Note that certificate authorities might charge for this service.

The CA might be responsible for checking that keys present in certificates it issues have been generated correctly and have sufficient cryptographic strength.

The client might try to find out whether the server certificate is revoked using the Online Certificate Status Protocol (OCSP). Using the TLS "status_request" extension, you can include this check inside the TLS handshake (known as "OCSP Stapling"), so that a separate connection from the client to an OCSP responder is not needed. To enable OCSP stapling, see [Configuring OCSP](#).

What is OCSP?

OCSP is an Internet protocol used for obtaining the current validity of an SSL certificate at the point of use. It was created as an alternative to Certificate Revocation Lists (CRLs) (see [CRLs in Client Authentication](#)) to address some of the inherent shortcomings of that method, such as the limitation that updates must be frequently downloaded to keep the list current.

When users attempt to access a secure service, they send an HTTP request to an OCSP server (known as a Responder) for the certificate's status information. This request is packaged in the form of an ASN.1 message, optionally signed with a certificate, and sent to the responder. In return, the responder sends back a response of "good," "revoked," or "unknown".

For further information on OCSP, see <http://tools.ietf.org/html/rfc6960>.

Client Authentication

In some cases, you might want to only allow certain approved people to access your service: for instance, a company Intranet or Extranet. To achieve this, you can require the client to provide an SSL certificate signed by a trusted certificate authority.

The Traffic Manager uses CRLs and OCSP to ensure the validity of these certificates.

CRLs in Client Authentication

Within the Traffic Manager your trusted certificate authorities are held in a catalog. Each certificate authority can distribute certificate revocation lists (CRLs), which are also held in this catalog. Certificates usually have a fixed validity period, such as 12 months, but sometimes a certificate is canceled before it expires. In this case the certificate authority adds it to a certificate revocation list, so that it will no longer be trusted.

OCSP in Client Authentication

You can use OCSP to check the current status of a client certificate. Unless the certificate is reported as being good, the SSL connection is terminated. To configure OCSP for your secure services, see [Configuring OCSP](#).

Encrypted Data Transfer

After the server and the client are satisfied with each other's identity, they agree on an encryption key to use for data transfer. This is different from their identification keys for reasons of efficiency. Data is encrypted before transfer so that a third party cannot read it. In addition, SSL has reliability features that ensure that any disruption to the data stream is detected. These features give client and server confidence that their communication is private, and has not been corrupted.

SSL Features in the Traffic Manager

Decryption and Encryption

The Traffic Manager can decrypt SSL traffic within a virtual server. This can be useful for two reasons:

- After decryption, the Traffic Manager's traffic analysis features can be used on the whole request. Service protection methods can filter for malicious content, viruses or Web worms; and rules can inspect the headers and body of the request to make an informed routing decision. Without decrypting the packets very little information is available.
- Decryption requires processing power. It might be more efficient if the Traffic Manager decrypts requests before passing them on to the nodes, reducing the load on the back-end servers.

If your virtual server is decrypting SSL traffic in order to use TrafficScript rules, you typically encrypt it again before sending it to the nodes. Encryption is handled by the pools you create in your Traffic Manager configuration, providing complete end-to-end security in your system.

SSL Certificates Catalog

The Traffic Manager uses an SSL certificate catalog to provide a centralized store of SSL server certificates, client certificates, certificate authorities and certificate revocation lists that your SSL services can use.

A virtual server manages traffic to a default service, and optionally to a number of "SSL sites" defined in the virtual server configuration. Each SSL site associates either an IP address or a hostname with a maximum of two SSL certificates from the catalog. For further information, see [Serving Multiple Sites Using a Single Virtual Server](#).

SSL Decryption Wizard

The **SSL Decrypt a service** wizard provides a step-by-step process to correctly configure SSL decryption. The wizard performs the following:

- Enables SSL decryption for an SSL virtual server.
- Assigns an SSL certificate from the Catalog to the virtual server.
- Enables SSL encryption for the default pool used by the virtual server.
- Changes all protocol types to the underlying (non-SSL) protocol type.



To use the **SSL Decrypt a service** wizard, you must have at least one SSL virtual server (of any type). If you do not have the necessary SSL certificates, the Traffic Manager helps you create a certificate from the wizard.

To use the SSL Decrypt a service wizard

1. Adjacent to the **Help** link in the toolbar, click the "Wizards" drop-down list and choose **SSL Decrypt a service**. A new window opens which explains that the wizard configures the service to be decrypted on receipt, and re-encrypts traffic before being passed to a pool. Click **Next**.
2. Select the service you want to decrypt. Note that only virtual servers that use an SSL protocol are listed. Click **Next**.
3. Choose which certificate to use to decrypt the incoming requests (or click Create New to add a certificate now). Click **Next**.
4. Choose a protocol type. This is the underlying decrypted protocol. For instance, HTTPS requests are decrypted to HTTP internally, so choose the underlying protocol HTTP as this matches the protocol type you are accepting, without the SSL wrapping.
5. Click **Finish** to complete the wizard.

Configuring SSL Certificates

To configure an SSL certificate, click **Catalogs > SSL** and then click **SSL Server Certificates catalog** or **SSL Client Certificates catalog** according to your requirements:

- "Server Certificates" are used to identify SSL-encrypted services hosted by the Traffic Manager.

- “Client Certificates” are used when the Traffic Manager needs to authenticate itself against an SSL node.



The following sections refer to functionality applicable to both Client and Server SSL certificates.

Creating a New Self-Signed SSL Certificate

To create a new self-signed SSL certificate

1. Click Catalogs on the top bar of the Admin UI, then click the SSL tab. From here, click the Edit button for either SSL Server Certificates Catalog (for Server certificates) or SSL Client Certificates catalog depending on your requirements.
2. The Traffic Manager lists any existing certificates that have been configured, and allows you to create or import a certificate. For testing purposes and internal use, an SSL certificate can be self-signed. This means that the certificate has not been signed by a trusted third party and should not be relied upon as a means of authenticating the server.

Enter a short name to identify your certificate. If you leave this blank, the 'Common Name' field or the first 'Subject Alternative Name' will be used.

Name:

List DNS names and IP addresses to include them in the certificate's Subject Alternative Name extension.

Subject Alternative Name(s):

Subject Alternative Name:

Subject Alternative Name:

The public DNS address of your server, such as 'secure.yourcompany.com':

Common Name (CN):

The name of your organization, such as 'Your Company':

Organization (O):

The unit within your organization, such as 'Sales':

Organizational Unit (OU): (optional)

Your location (town or city), such as 'Anytown':

Location (L):

Your state or province, such as 'Somestate':

State (S): (required for US only)

Your two-letter country code, such as 'US', 'GB' or 'FR':

Country (C):

How long should this certificate be valid for:

Expires in:

Private key type (2048 bit RSA or P-256 ECDSA recommended):

Key type:

3. Click **Create Self-Signed Certificate / Certificate Signing Request**.
4. Give the certificate a descriptive **Name**.
5. Click the "+" icon to add one or more **Subject Alternative Names** for this certificate. For each entry, use a valid DNS name or IP address that you want to be protected by this certificate.
6. Type a **Common Name (CN)**, which should be the DNS name of the server that uses this certificate, such as "secure.yourcompany.com". Most clients show a warning message if the CN in the certificate and the DNS address of the server do not match. If one or more subject alternative names are specified, the Common Name is not used by RFC6125 compliant client software.
7. Supply values for your **Organization, Organizational Unit, and Address**. These appear in the certificate.

8. Enter your **Country** code using the two-letter ISO country code standard¹. For example, Great Britain is "GB", and Germany is "DE".
9. Set an **Expires In** date for the certificate (default, one year).
10. Select a private key size (**Key type**) for the certificate. Choose P256, P384, or P521 to create a certificate containing an ECDSA key, or choose 1024, 2048, 3072 or 4096 create a certificate containing an RSA key.
11. Click **Create Certificate**. If there are no errors the Traffic Manager will create an SSL certificate and place this in the SSL Certificates Catalog.

You can verify that the certificate has been added by clicking the expansion tab on the **Catalogs** page, beside **SSL Certificates Catalog**. Each certificate is listed in a table, and the expiry date of the certificate is also indicated.

Managing Certificate Data

To change an existing self-signed certificate, update the values in the Edit Certificate page and generate a new self-signed certificate based on the modified fields.

To do this, click **Catalogs > SSL > SSL [Client | Server] Certificates Catalog**. Next, click the name of an existing self-signed SSL certificate to access the Edit Certificate page. In the "Edit Certificate" section, change any of the existing fields for the certificate and then click **Update Certificate**.



You cannot edit a certificate signed by a Certificate Authority as the replacement certificate would be self-signed. To update a signed certificate, create a new self-signed certificate and make a new certificate signing request based upon it.

To create a copy of an SSL certificate under a new name, use the "Copy Certificate" section. Enter a new name for the copy and click **Copy Certificate**. The new SSL certificate is added to the relevant catalog immediately.

Creating a Certificate Signing Request

A Certificate Signing Request (CSR) is a formal request made by an individual to a certificate authority (CA) to obtain a digital identity certificate. Certificate Authorities are entities responsible for issuing certificates for use by other parties.

¹As defined in the ISO-3166 standard.

After you have created your self-signed certificate, you can then create a Certificate Signing Request based on the information in the self-signed certificate:

1. Go to the **Catalogs > SSL > [Server|Client] Certs** screen.
2. Click to edit the required certificate.
3. In the "Certificate Signing" section, click **Export CSR/Update certificate**.

The Traffic Manager displays the certificate request:

SSL
Certificates
Catalog

SSL Certificate: SSL Cert 1

This form helps you to sign your certificate.

Certificate Signing Request (CSR)

Your Certificate Authority will use this Certificate Request text to create and issue a trusted certificate, based on this certificate.

```
-----BEGIN NEW CERTIFICATE REQUEST-----
MIIBqDCCARECAQAwaDELMAkGA1UEBhMCR0Ix EjAQBgNVBAcTCUNhbWJyaWRnZTER
MA8GA1UEChMIUm12ZXJiZWQx FDASBgNVBAcTCORldmVsb3BtZW50MRwwGgYDVQQD
ExNzZWN1cmUuem12ZXJiZWQxY29tMIGfMA0GCSqGSIb3DQEBAQUAA4GNADCBiQKB
gQDfmczksdumadLvx19PLHBpykMfr200SY4n+1zuYhvKJqLbmesFQv5+41v+Jw3Z
zhTd/S/GgzieXl+3z9PMo9x15HQD3Ey7fEB7rum6iAFnccf7nV55hJWthpMEPMSo
tTCrBODoX5t/i1V90FuFoypKGyYBcjstqREpbPvneN0ukwIDAQABoAAwDQYJKoZI
hvcNAQEFBQADgYEAiuV66PRzBYv1NJ2qY1E20lHxbEyXaqBORG+Ysb++UcXgMwS3
x/+Kr9i/eOSPLSO77sB7+Wvx2IIBrzzG2hoagCOOLUKCyLPWdlm03BpTKZCYTbyK
Y72PP5BPVDo6eoFj fMNMA02RuzA8POEAluUh2V8BMDmJmVvy3mXBtVH6v4E=
```

Replace certificate

Once you have received a new certificate, paste it here to replace your current certificate.

Note: This will completely replace your current certificate. You may wish to copy your current certificate before doing this.

The text in the upper part of the window contains an encoding of the information in the stored certificate suitable for the CA to sign. You can copy and paste this text into the request. You may be asked to attach other credentials or extra information to your request.

The Certificate Authority returns a replacement certificate that they have digitally signed with one of their public certificates (or a certificate in a public certificate chain). Paste the textual contents of the returned certificate in the lower part of the window, and click **Update certificate** to complete the process.

Importing a New SSL Certificate

To import an existing certificate, you require the following items:

- The certificate file.
- The private key file.

These files are in a standard, PEM-encoded format that can be cut and pasted into a text file for uploading. PEM-encoded certificates are formatted as follows:

```
-----BEGIN CERTIFICATE-----
MIIBPLMAkGA1UEBhMCWkExFTATBgNVBAGTDGFd1c3R1cm4gQ2Fw
ZTESMwZSBUb3duMRQwEgYDVQQKEwtPcHBvcnR1bm10aTEYMBYG
A1UEC1cnZpY2VzMR0wGAYDVQQDExF3d3cuZm9yd2FyZC5jby56
YTBaMBAQUAA0kAMEYCCQDT5oxxeBWu5WLHD/G4BJ+PobiC9d7S
6pDvAtXdm2j190D1kgDoSp5ZyGSgwJh2V7diuuPlHDAgEDoAAw
DQYJKDQQBf8ZH1u4H8ik2vZQngXh8v+iGnAXD1AvUjuDPCWzFu
pReiq7UR8Z0wiJBeaqiuuTDnTFMz6oCq6htdH7/tvKhh==
-----END CERTIFICATE-----
```

Click the **Import Certificate** link in the relevant Client/Server SSL Certificate Catalog to perform the upload. Provide a name for the imported certificate, and the names of the Certificate and Private Key files. Finally, click **Import Certificate** to complete the process. The Traffic Manager adds the certificate to the appropriate catalog and automatically distributes the key data securely to all Traffic Managers.

ATTENTION

Do not forget to delete temporary copies of your SSL private key that you may have created during the import process. The private key is valuable and should never be stored in an insecure location.

When a certificate signed by a Certificate Authority is not signed directly by the “root certificate” it might be necessary to send clients both the signed certificate and the Certificate Authority's intermediate certificate.

Working with Intermediate Certificates

Web Browsers and other SSL clients are preconfigured with a set of root certificates from Certificate Authorities that they trust. They will allow the user to connect to an SSL service that uses an SSL Server Certificate signed by one of the trusted Certificate Authorities. Similarly, back-end SSL nodes may be pre-configured to authenticate Client SSL certificates presented by the Traffic Manager.

However, for ease of management and improved security, many certificate authorities use “certificate chains”. The SSL certificates they distribute are not signed directly by a root certificate; rather they are signed by an intermediate certificate which is itself signed by the root. This forms a chain of trust from the SSL certificate back to the trusted root certificate. In some cases, a chain of two or more intermediate certificates is used between the SSL certificate and the root.

Web clients and SSL nodes are generally not equipped with the intermediate certificates. If, for example, a Web client is presented with a server certificate, it has no way of verifying that it was signed (albeit indirectly) by a trusted root certificate. In this case, the SSL server (i.e. the Traffic Manager) must present the entire or partial SSL certificate chain so that the client can verify the SSL certificate – the certificate chain includes the SSL certificate and all intermediate certificates. It is not necessary to include the root certificate.

Your certificate authority will inform you if a chain of certificates is used. You need to upload all of the intermediate certificates to the relevant Server or Client SSL certificate catalog:

Certificate signing

This certificate has been signed by an external 'Certificate Authority'. You can replace it with a new certificate, for example if it has nearly expired, your details have changed, or you have a new certificate signed by another Certificate Authority.

⏴ **Export CSR / Update Certificate**

⏵ **Add Intermediate Certificate**

The Traffic Manager will verify that the intermediate certificate you upload has signed the current SSL certificate (or the previous intermediate certificate in the chain).

Managing Certificate Authority Certificates and CRL Files

The Traffic Manager can request that remote clients who connect over SSL provide a client certificate to authenticate themselves. To enable this behavior, configure the Traffic Manager with the public certificates from the Certificate Authorities (CAs) you trust, and optionally any Certificate Revocation Lists (CRLs) that they distribute.

With one or more CA certificates installed, each pool in your Traffic Manager configuration that has `ssl_encrypt` and `ssl_strict_verify` enabled then enforces authentication of certificates issued by the owner of the CA certificate when a connection is attempted.

To manage your CA certificates and CRLs, click **Catalogs > SSL > Certificate Authorities and Certificate Revocation Lists Catalog**.

To import a new CA or CRL file into the Traffic Manager, click **Import certificate or CRL**, and use one of the following methods:

- Click **Choose File** to upload a certificate or CRL file from your local workstation to the Traffic Manager.
- Type an HTTP URL or an HTTPS URL into the **File URL** box for the Traffic Manager to download directly.
- Type or copy the contents of a file into the **File Contents** box (PEM-encoded).

Click **Import File** to complete the process. The Traffic Manager imports the CA or CRL file and propagates the new information to all Traffic Managers in the cluster.



Make sure that the CA performs public key validity checks for certificates it issues in order to ensure cryptographic security when encrypted connections are made to nodes, or when virtual servers are configured to authenticate client certificates. For example, if FIPS Mode is enabled, only CAs known to have performed the checks as required by NIST SP 800-89 "Recommendation for Obtaining Assurances for Digital Signature Applications" (section 5.2) should be included in the CAs catalog.

SSL Decryption

The Traffic Manager can decrypt and re-encrypt SSL traffic dynamically as it proxies requests between clients and back-end pools, utilizing server and client certificates stored in the SSL Catalog.

After decrypting traffic, for example, to apply TrafficScript rules, the Traffic Manager can re-encrypt the data if required before passing it to the nodes. This allows flexible management of requests without compromising security requirements on potentially untrusted networks. The Traffic Manager thus provides a fully transparent SSL gateway.

As the computational resources available to cryptographic attackers increases, stronger keys are required to secure SSL/TLS sites. However, the processing time needed to use longer DSA and RSA keys increases rapidly with key length. To address this issue, the Traffic Manager provides the option of Elliptic Curve Cryptography (ECC) due to its increased efficiency with stronger keys. Specifically, the Traffic Manager supports keys based on the Elliptic Curve Digital Signature Algorithm (ECDSA).

Setting Up SSL Decryption

To enable SSL decryption, click **Services > Virtual Servers** and then click the **Edit** button for a virtual server that supports SSL.

In the list of configuration options for the virtual server, click the **Edit** button for "SSL Decryption".

The Traffic Manager displays a list of configuration options for SSL decryption for this virtual server.

▼ SSL Decryption

These settings control how SSL connections are decrypted.

Whether or not the virtual server should decrypt incoming SSL traffic.

ssl_decrypt: Yes No

Which SSL certificate(s) should this virtual server use?
 Additional certificates can be supplied to match different sites hosted by this virtual server. You can specify a different certificate for any hostname or IP address. The wildcard character '*' can be used to match multiple hostnames. If none of the addresses or hostnames match the default certificate will be used.

Note: Hostname mappings require support of the TLS 1.0 'Server Name Indication' extension, which is not supported by all browsers.

certificate: Default Certificates: RSA-Cert (secure.pulsesecure.net, Expires 04 Oct 2018, RSA) ▾
ECDSA-Cert (secure.pulsesecure.net, Expires 04 Oct 2018, RSA) ▾

| IP Address / Host Name | Certificate | Remove |
|-------------------------|--|--------------------------|
| example.pulsesecure.net | RSA-Site-Cert (secure.pulsesecure.net, Expires 04 Oct 2018, RSA) ▾ | <input type="checkbox"/> |
| | ECDSA-Site-Cert (secure.pulsesecure.net, Expires 04 Oct 2018, RSA) ▾ | <input type="checkbox"/> |

Add certificate mapping:

IP Address / Host Name:

Certificates: Select a certificate... ▾
Select a certificate... ▾

Manage SSL Certificates

Whether or not the virtual server should add HTTP headers to each request to show the SSL connection parameters.

ssl_headers: Yes No

If the traffic manager is receiving traffic sent from another traffic manager, then enabling this option will allow it to decode extra information on the true origin of the SSL connection. This information is supplied by the first traffic manager.

ssl_trust_magic: Yes No

Whether or not to send an SSL/TLS "close alert" when the traffic manager is initiating an SSL socket disconnection.

ssl_send_close_alerts: Yes No

If OCSP URIs are present in certificates used by this virtual server, then enabling this option will allow the traffic manager to provide OCSP responses for these certificates as part of the handshake, if the client sends a TLS status_request extension in the ClientHello.

ssl_ocsp_stapling: Yes No

To enable SSL decryption, set **ssl_decrypt** to "Yes" and click **Update** at the bottom of the page.

Use the **certificate** setting to select the certificates you want to use for the default SSL site. To add certificate mappings for additional SSL sites handled by this virtual server, use the "Add certificate mapping" section.

In all cases, choose either one or two certificates using the pair of drop-down lists provided. If you specify a single certificate, you can use any applicable certificate key type. However, if you specify two certificates, you must select a different key type for each one. For more details, see [Using Multiple Certificates to Achieve Compatibility With More Clients](#).

You can also configure the following settings:

- **ssl_headers:** The Traffic Manager includes the option to add HTTP headers with details about the decryption performed (HTTPS decryption only). These describe the client cipher, session ID and whether a valid client certificate was provided, and can be inspected by the back-end application to determine what encryption parameters were used.

| Header name | Sample Value |
|---------------------|--|
| SSLClientCipher | SSL_RSA_WITH_AES_128_CBC_SHA256, version=TLSv1.2, bits=128 |
| SSLClientCertStatus | NoClientCert or OK |
| SSLSessionID | 8723367551317ABE5443278C6E... (64 hex characters) |

- **ssl_trust_magic:** If you have a setup involving two distinct clusters of Traffic Managers, SSL traffic forwarded from one cluster to the other typically appears to originate from the first cluster. Use this setting to instruct your Traffic Managers to pass the true origin IP addresses of the connections to each other.



To use this setting, your Traffic Managers must be properly configured. For more information, see the **ssl_enhance** setting in your pool's SSL configuration.

- **ssl_send_close_alerts:** To avoid truncation attacks, the SSL specifications require that the client and server share the knowledge that a connection is ending by sending a close alert. This setting is enabled by default as some clients, especially FTP clients, are strict with close alerts and fail to function properly if the alerts are omitted. Note that close alerts can break some older SSL implementations, including some versions of Microsoft Internet Explorer. Ivanti recommends disabling this setting if your services are affected. You can also modify this behavior dynamically by using TrafficScript rules.

- **ssl_ocsp_stapling:** Enable this option to allow the virtual server to include an OCSP certificate status in the TLS handshake, provided that a status_request extension is sent by the client. It also triggers OCSP requests for each of the virtual server's certificates to be made in the background to the responders named in each certificate's "Authority Information Access" extension's OCSP URI. This option is disabled by default.

Click **Update** to apply the changes to the virtual server.

Serving Multiple Sites Using a Single Virtual Server

There are two ways that the Traffic Manager can distinguish between different services:

- **Destination IP address:** "secure.site1.com" and "secure.site2.com" could resolve to different IP addresses. The Traffic Manager can listen on both IP addresses and select the certificate to use based on the IP address the connection was received on.
- **TLS Server Name Indication¹:** TLS has an optional capability where a client can provide the name of the service it is trying to contact (in plain text format) at the very beginning of the TLS handshake. The Traffic Manager can inspect this name and chose the certificate to use.

ATTENTION

TLS Server Name Indication is scalable and easy to manage, as it does not require each SSL service to be running on a dedicated IP address. However, some older Web clients such as Internet Explorer 7 (Windows XP) do not support this feature and can receive the wrong certificate if they attempt to access a service that requires TLS server name support.

If your virtual server is managing traffic for more than one site, you must configure the virtual server with a certificate containing a Subject Alternative Name to match each site the client is trying to access. If the client is unable to locate a Subject Alternative Name that matches the DNS name of the service, the client can fall back to checking the Common Name (CN) field instead. The client warns the end user if there is no match.

Configuring Multiple Certificates

A single certificate can contain multiple Subject Alternative Names to match each SSL site served by the virtual server, in which case you need only configure the virtual server to use that certificate as it's default.

¹http://en.wikipedia.org/wiki/Server_Name_Indication

Alternatively, you can configure the virtual server with multiple certificates, each with a single Subject Alternative Name matching one of the SSL sites. You then configure the virtual server to use specific certificate mappings using the "Add certificate mapping" section.

Create a new certificate mapping by specifying either an IP address or host name in the first text box and then selecting a certificate from the drop-down list. To save this mapping, click **Update** at the bottom of the page.

When the Traffic Manager receives a request it checks the certificate settings to determine the certificate to send. If a connecting client provides a server name in their SSL handshake that matches the host name in a mapping, or if the client connects to an IP address specified in a mapping, they are given the nominated certificate rather than the default certificate.

The Traffic Manager chooses the first matching certificate. Exact matches of server name come first, then wildcard matches of server name, and finally exact matches of IP address. If there are no matches, the default certificate is used.

If more than one certificate mapping using a wildcard matches the server name, the Traffic Manager uses the mapping with the most non-wildcard characters first. For example, if the client sends the server name "www.foo.example.com", the Traffic Manager uses the certificate associated with a mapping for "*.foo.example.com" in preference to a mapping for "*.example.com".

Using Multiple Certificates to Achieve Compatibility With More Clients

When configuring the default certificate on a virtual server, or when configuring a certificate mapping for an IP address / hostname, the Traffic Manager allows you to configure two separate certificates. During the SSL handshake, the Traffic Manager chooses a combination of cipher suite, signature algorithm, and server certificate that the client has indicated support for. It can therefore be advantageous to provide the following:

- One certificate chain using an ECDSA key, and one using an RSA key to be used by pre-TLSv1.3 clients that don't support ECDSA ciphers
- One certificate chain using RSA-PSS signatures and one using only PKCS1-v1_5 signatures



If multiple certificate chains would be accepted by the client, the Traffic Manager sends the first chain that is compatible with its most preferred combination of cipher suite and signature algorithms. For more details, see [Configuring Ciphers and TLS Versions](#).

Configuring Ciphers and TLS Versions

As cryptographic algorithms weaken naturally over time, SSL and TLS are able to negotiate between multiple potentially-supported algorithms, providing the following advantages:

- Authentication of endpoints
- Key exchange
- Bulk encryption

The Traffic Manager enables you to configure the algorithms available to be negotiated through your services, and in some circumstances to set priorities for the available algorithms.

The Traffic Manager contains global default settings for your security configuration, although this can be overridden on a per-virtual server or per-pool basis for dedicated control over particular services. The Traffic Manager also contains settings that control the configuration to be used for the Admin UI and REST API. The sections that follow describe the available controls.

Protocol Versions

The Traffic Manager supports SSLv3, TLSv1.0, TLSv1.1, TLSv1.2, and TLSv1.3 for all SSL connections.

When a client connects to a server, negotiation of a protocol version is one of the first actions performed. When acting as a server, the Traffic Manager always selects the highest supported version for which the client advertises support. Some of the subsequent elements of cipher selection have slightly different impacts for different protocol versions.

To configure which protocol versions are enabled, see the following pages of the Admin UI:

- For administration interface and control plane connections, click **System > Security > SSL Settings for Admin Server and Internal Connections**. Use the "admin!support_<version>" settings to configure protocol support.
- For global defaults for service connections, click **System > Global Settings > SSL Configuration**. Use the "ssl!support_<version>" settings to configure protocol support for your services.
- To override the global defaults for individual virtual servers, click **Services > Virtual Servers > Edit > SSL Decryption** and configure the "ssl_support_<version>" settings.
- To override the global defaults for individual pools, click **Services > Pools > Edit > SSL Settings** and configure the "ssl_support_<version>" settings.

Cipher Suites

The Traffic Manager allows you to configure a bespoke list of cipher suites (in preference order) available to be used by SSL connections. To see the full list of cipher suites currently supported by the Traffic Manager, view the UI Help for the **System > Global Settings > SSL Configuration** page.



Some cipher suites shown in the UI Help are marked as supported but disabled by default. To allow the Traffic Manager to use these cipher suites, you must explicitly add them into your cipher suites preference lists. Alternatively, use the special value "all" to force the Traffic Manager to enable the complete list of cipher suites.

The Traffic Manager uses separate cipher suites preference lists for different connection types. To configure cipher suite preference lists, see the following pages of the Admin UI:

- For administration interface and control plane connections, click **System > Security > SSL Settings for Admin Server and Internal Connections** and configure the "admin!ssl3_ciphers" setting. Leave this field blank to allow the use of all cipher suites enabled and supported by this Traffic Manager.
- To set a global preference list for all other connections, click **System > Global Settings > SSL Configuration**. Use the "ssl!cipher_suites" setting to configure a cipher suites preference list for your virtual servers and pools. Leave this field blank to allow the use of all cipher suites enabled and supported by this Traffic Manager.
- To override the global preference list for an individual virtual server, click **Services > Virtual Servers > Edit > SSL Decryption** and set "ssl_cipher_suites" to your dedicated cipher suite list. Leave this field blank to use the global list.
- To override the global preference list for an individual pool, click **Services > Pools > Edit > SSL Settings** and set "ssl_cipher_suites" to your dedicated cipher suite list. Leave this field blank to use the global list.

Prior to TLSv1.3, selection of a given cipher suite determined the following:

- The type of public key that the server must present as authentication. Supported key types are ECDSA, RSA, and DSA.
- The algorithm to be used for key exchange. Supported algorithms are ECDHE, DHE, and non-Diffie-Hellman RSA.
- The bulk encryption algorithm to be used. Supported algorithms are AES-GCM, AES-CBC with HMAC, 3DES with HMAC, RC4 with HMAC, and DES with HMAC.

The names used by the Traffic Manager for pre-TLSv1.3 cipher suites are formed by replacing the "TLS_" prefix in the Internet Assigned Numbers Authority (IANA) TLS Cipher Suites registry (<https://www.iana.org/assignments/tls-parameters/tls-parameters.xhtml>) with the "SSL_" prefix.

For example, the Traffic Manager cipher `SSL_ECDHE_ECDSA_WITH_AES_256_CBC_SHA` represents the IANA cipher suite `TLS_ECDHE_ECDSA_WITH_AES_256_CBC_SHA`. When using this cipher suite, the server must present an ECDSA public key in the server certificate as authentication. The key exchange algorithm in use is ECDHE, and 256-bit AES-CBC is used for bulk encryption.

For TLSv1.3 and later, the meaning of cipher suites has changed. Here, selection of a given cipher suite no longer affects public key or key exchange algorithms, and only determines the algorithm to be used for bulk encryption. The names used by the Traffic Manager for TLSv1.3 cipher suites are the same as the names in the IANA TLS Cipher suites registry.

When acting as a server and choosing a cipher suite, the Traffic Manager selects the available suite that appears first in the applicable cipher suites list. The selected suite must be compatible with a configured certificate and must have a compatible signature algorithm available; in this case, client preference is not taken into consideration. The Traffic Manager chooses a cipher suite before choosing a signature algorithm.

Signature Algorithms

Using a public key to verify a signature is a key concept in TLS. This approach is used to validate certificate chains and to authenticate remote entities in a TLS handshake by verifying a signature that is provided of some known content. The Traffic Manager typically supports signature algorithms based around ECDSA, DSA, and RSA. For RSA, the PKCS1 standard (<https://tools.ietf.org/html/rfc8017>) defines two signature schemes:

- PKCS1-v1_5
- PSS

The Traffic Manager supports both schemes when validating certificate chains. When signing/verifying handshake signatures, PKCS1-v1_5 is supported for TLSv1.2 and earlier, and PSS is supported for TLSv1.2 and later.



PSS is unsupported for TLSv1.2 CertificateVerify handshake messages.

The Traffic Manager uses signature algorithms to verify certificate signatures, and when signing or verifying handshake signatures (from TLSv1.2 onwards). To restrict the algorithms available for this purpose, set system-wide preference lists in the Global Settings, or set local override lists in your virtual server and pool SSL settings. When the Traffic Manager needs to choose a signature algorithm to use (for example, when generating a handshake signature) it uses the first signature algorithm listed that is compatible with the cipher suite.

To see the full list of signature algorithms currently supported by the Traffic Manager, view the UI Help for the **System > Global Settings > SSL Configuration** page.

To configure signature algorithm preference lists, see the following pages of the Admin UI:

- For administration interface and control plane connections, click **System > Security > SSL Settings for Admin Server and Internal Connections** and configure the "admin!ssl_signature_algorithms" setting. Leave this field blank to allow the use of all signature algorithms supported by this Traffic Manager.
- To set a global preference list for all other connections, click **System > Global Settings > SSL Configuration**. Use the "ssl!signature_algorithms" setting to configure a signature algorithms preference list for your virtual servers and pools. Leave this field blank to allow the use of all signature algorithms supported by this Traffic Manager.
- To override the global preference list for an individual virtual server, click **Services > Virtual Servers > Edit > SSL Decryption** and set "ssl_signature_algorithms" to your dedicated signature algorithms list. Leave this field blank to use the global list.
- To override the global preference list for an individual pool, click **Services > Pools > Edit > SSL Settings** and set "ssl_signature_algorithms" to your dedicated signature algorithms list. Leave this field blank to use the global list.



For the virtual server or pool "ssl_signature_algorithms" settings, enter the special value "default" to force the corresponding virtual server or pool to ignore any value set in the global preference list and instead use the default list of signature algorithms declared as supported (and not disabled) in the UI Help.

When acting as a server and choosing a signature algorithm, the traffic manager chooses the available algorithm that is first in the application signature algorithms list, that is compatible with the chosen cipher suite and with a configured certificate. The traffic manager chooses a signature algorithm after choosing a cipher suite.

When acting as a server and choosing a signature algorithm, the Traffic Manager selects the available algorithm that appears first in the applicable signature algorithm list. The selected algorithm must be compatible with the chosen cipher suite and with a configured certificate. The Traffic Manager chooses a signature algorithm after choosing a cipher suite.

Elliptic Curves

The Traffic Manager uses elliptic curves for ECDHE key exchange and for ECDSA authentication. The following curves are supported:

- NIST P-256 (also known as SECG secp256r1 or ANSI x9.62 prime256v1)
- NIST P-384 (also known as SECG secp384r1)
- NIST P-521 (also known as SECG secp521r1)

To restrict and prioritize the elliptic curves available for the Traffic Manager to use for ECDHE key exchange, or when signing/verifying ECDSA signatures, set system-wide preference lists in the Global Settings, or set local override lists in your virtual server and pool SSL settings.

To configure elliptic curve preference lists, see the following pages of the Admin UI:

- For administration interface and control plane connections, click **System > Security > SSL Settings for Admin Server and Internal Connections** and configure the "admin!ssl_elliptic_curves" setting. Leave this field blank to allow the use of all elliptic curves supported by this Traffic Manager.
- To set a global preference list for all other connections, click **System > Global Settings > SSL Configuration**. Use the "ssl!elliptic_curves" setting to configure an elliptic curves preference list for your virtual servers and pools. Leave this field blank to allow the use of all elliptic curves supported by this Traffic Manager.
- To override the global preference list for an individual virtual server, click **Services > Virtual Servers > Edit > SSL Decryption** and set "ssl_elliptic_curves" to your dedicated elliptic curves list. Leave this field blank to use the global list.
- To override the global preference list for an individual pool, click **Services > Pools > Edit > SSL Settings** and set "ssl_elliptic_curves" to your dedicated elliptic curves list. Leave this field blank to use the global list.



For the virtual server or pool "ssl_elliptic_curves" settings, enter the special value "default" to force the corresponding virtual server or pool to ignore any value set in the global preference list and instead use the full list of supported elliptic curves.

Client Certificates

While SSL server certificates are used to identify servers in an SSL transaction, SSL also allows for the use of Client Certificates so that clients can identify themselves when required.

By default, the Traffic Manager does not request a client certificate from clients that connect to a virtual server. If required, you can configure the virtual server to request that clients provide client certificates.

To control how clients are authenticated in an SSL transaction, use the following settings:

- **request_client_cert:** Specify whether the virtual server should request an identifying certificate from each client, and whether supplying a certificate should be optional or compulsory (in other words, all clients must present a valid client certificate). If **request_client_cert** is set to "Do not request a certificate" (the default setting), a client is prevented from sending a certificate whether it wants to or not.
- **ssl_client_cert_headers:** After the request has been decrypted, the Traffic Manager can optionally set HTTP headers that record the certificate fields from the SSL Certificate used:

| Header Name | Sample Value |
|---------------------------------|--|
| SSLClientCertVersion | 3 |
| SSLClientCertSerialNumber | ED41A8 |
| SSLClientCertIssuer | C=US, ST=CA, L=San Jose, O=MyOrg |
| SSLClientCertSubject | C=US, ST=CA, L=San Jose, O=MyOrg |
| SSLClientCertNotValidBefore | 1155304575 (unixtime) |
| SSLClientCertNotValidAfter | 1186840575 (unixtime) |
| SSLClientCertSubjectPublicKey | RSA (2048 bit) |
| SSLClientCertSignatureAlgorithm | sha256withRSAEncryption |
| SSLClientCertHash | 873FECCB50E0C1D34711ABE65BA70BA7 |
| SSLClientCertSHA1Fingerprint | 7D90A8EB6081183C0560970A7DA77306C40E5DD2 |

| Header Name | Sample Value |
|----------------------------|---|
| SSLClientCert (if enabled) | <i>The entire PEM-encoded certificate text.</i> |

- **client_cas**: When client certificates are in use, the Traffic Manager must be able to verify that the certificate it is given is legitimate. The Traffic Manager informs the client which CAs it trusts and the client sends a certificate signed by one of these CAs (if available). To use this setting, first configure your trusted CA certificates in the “Certificate Authorities and Certificate Revocation Lists Catalog” and then select the CAs here as required. If the client supplies a certificate that is not recognized by the CAs you specify, the Traffic Manager immediately closes the connection and sends an SSL error to the client.

The **request_client_cert**, **client_cas**, and **ssl_client_cert_headers** settings can be overridden if the TLS connection being made to the virtual server uses specified destination IP addresses or includes a *Server Name Indication* extension with specified DNS names.

Server Name Indication (SNI) is an extension defined for TLS handshakes that allows a TLS client to tell a TLS server which server it is connecting to. This can be useful if the DNS entries for several different servers resolve to the same IP address, as it allows multiple distinct applications to be served from that IP address.

▼ ✔ SSL Client Authentication

These settings control how clients are authenticated in SSL transactions.

Whether or not the virtual server should request an identifying certificate from each client.

request_client_cert:

Do not request a client certificate

What HTTP headers the virtual server should add to each request to show the data in the client certificate.

ssl_client_cert_headers:

No data

The certificate authorities that this virtual server should trust to validate client certificates. If no certificate authorities are requested, then all client certificates will be accepted.

client_cas:

No certificate authorities selected, all certificates are accepted.

Add new Certificate Authority to the list.



Manage Certificate Authorities

Specific CA certificates can be used when requesting client certificates for different sets of addresses. You can specify a different set of CA certificates for any DNS hostname or IP address. The wildcard character * can be used to match none of the addresses or hostnames match the **request_client_cert**, **ssl_client_cert_headers**, or **client_cas** settings.

Note: Hostname mappings require support of the TLS 1.0 'Server Name Indication' extension.

| Host or IP | Request Certificate | Insert HTTP Headers | CAs |
|------------------|------------------------|---------------------|------------------|
| www.example.com | Yes, allow if absent ▼ | Fields ▼ | 10.62.165.195-CA |
| www2.example.com | Yes, deny if absent ▼ | Fields ▼ | 10.62.165.195-CA |

Add hostname/IP address mapping for client authentication

Host or IP:

Request Certificate:

No ▼

Insert HTTP Headers:

None ▼

CAs:

10.62.165.195-CA

Where SNI extensions are supported and used, the Traffic Manager enables you to add specific hostname or IP address mappings to apply to incoming connections. To add a mapping, use the **Add hostname/IP address mapping for client authentication** section.

Specify the map parameters using the following settings, then click **Update** to add the mapping:

| Setting | Description |
|---------------------------------|--|
| Host or IP | This is the string used to match the incoming connection, and can be given as a DNS name if the contents of the SNI should be matched, or as an IP address if the destination IP address of the connection should be matched. In either case the "*" character can be given in place of multiple characters in the SNI or IP address being examined. |
| Request Certificate | <p>Whether the initial TLS handshake requests a client certificate.</p> <p>Choose from:</p> <p>No: No certificate request to be made.</p> <p>Yes, allow if absent: A certificate request to be made but to allow connection processing to continue if the client declines to provide a certificate.</p> <p>Yes, deny if absent: A certificate request to be made and the connection aborted if no client certificate is supplied.</p> <hr/> <p> The option to not request a certificate can be used with connections made using TLS versions that support re-handshaking (TLS versions prior to v1.3) in conjunction with the TrafficScript functions <code>ssl.requestCert()</code> and <code>ssl.requireCert()</code>.</p> <hr/> |
| Insert HTTP Headers (HTTP only) | <p>The HTTP header fields, if any, that should be added to the request before it is sent to a pool node.</p> <p>Choose from:</p> <p>None: No header fields are inserted.</p> |

| Setting | Description |
|---------|---|
| | <p>Fields Only: Insert the header fields as described for ssl_client_cert_headers.</p> <p>Fields and PEM: As above, with the "SSLClientCert" header containing the full certificate.</p> |
| CAs | <p>Which certificate authorities should be used in the certificate request, so that the client can decide whether it has one or more certificates issued by those authorities. Each checked certificate authority is included in the certificate request.</p> <p>If no certificate authorities are checked, any certificate supplied by the client is considered to authorize access and allow the connection to proceed.</p> |

To remove a mapping, select the adjacent checkbox in the **Remove** column, and click **Update**.

The following settings allow the client certificate chain validation to ignore expiry dates for selected client certificate authorities:

- issued_certs_never_expire** and **issued_certs_never_expire_depth**: For organizations experiencing issues with their public key infrastructure, use these settings to enable expert level control over your client certificate configuration. Use **issued_certs_never_expire** to define a subset of the CAs that are configured as part of the **client_cas** list. Ordinarily, if any certificate in a chain is expired the Traffic Manager fails to validate the chain, meaning that if a client certificate is required the TLS handshake fails. When a CA is configured under this setting, the Traffic Manager ignores the expiry of any certificates in a certificate chain that is built up to that given CA as a trust anchor. This property can be further constrained by configuring a value in **issued_certs_never_expire_depth**. This setting indicates how far removed from the trust anchor a certificate is permitted to be for its expiry to be ignored. The default setting is "1", meaning that only certificates directly issued by the CA are permitted to be expired in a validated client certificate chain.

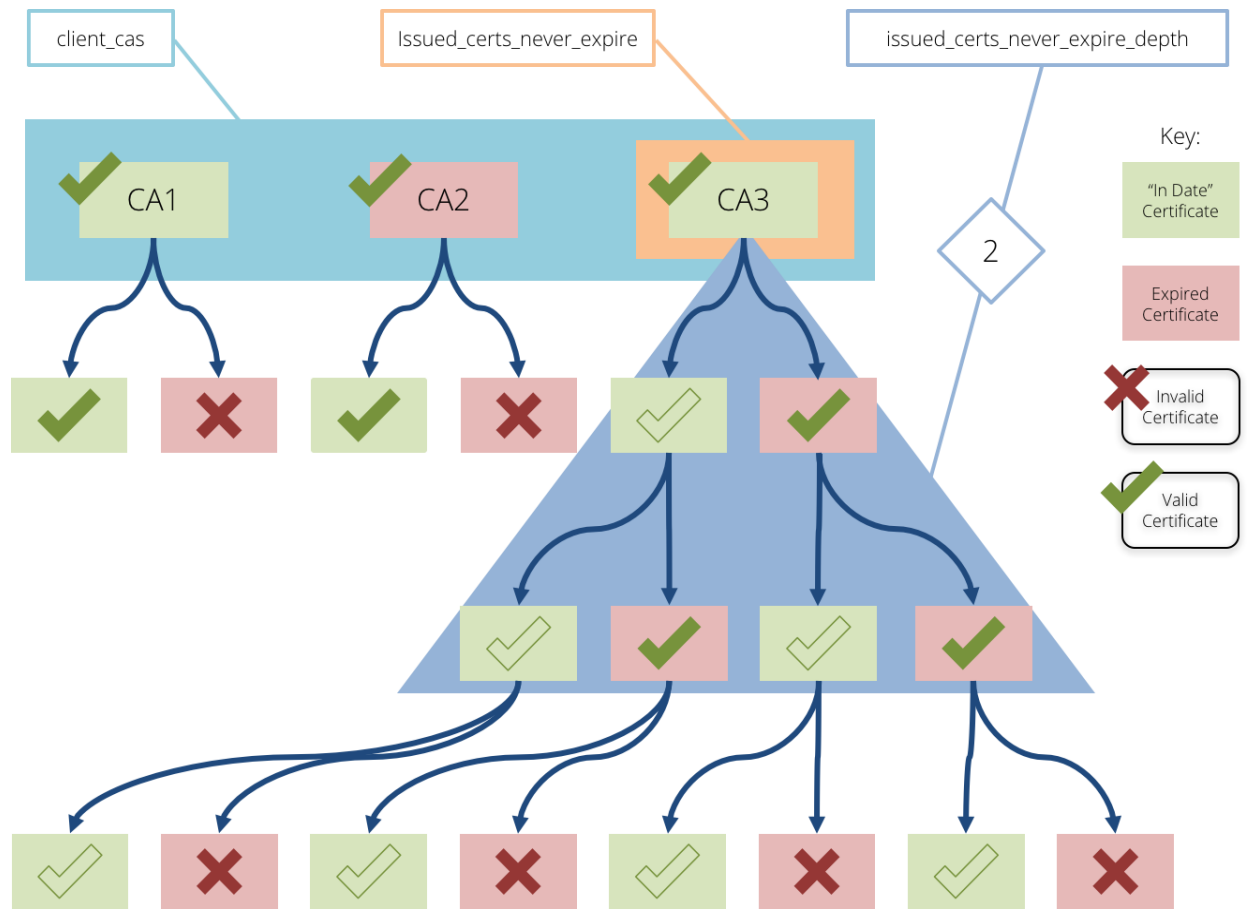

Configuring OCSP

The Online Certificate Status Protocol (OCSP) can be used to check the revocation status of certificates from a centralized server called an OCSP responder. OCSP is commonly used as an alternative to Certificate Revocation Lists (CRLs). For further details, see [Client Authentication](#).

The Traffic Manager provides a dedicated section under **Virtual Servers > SSL Decryption** for configuring OCSP. To configure OCSP, use the following settings:

| Setting | Description |
|--------------|--|
| ssl_use_ocsp | If set to yes, this virtual server will use OCSP to verify that client certificates have not been revoked. |

| Setting | Description |
|---------------------------|---|
| ssl_ocsp_timeout | When contacting an OCSP responder, the Traffic Manager waits for a response for the amount of time specified by this setting. If the OCSP responder has not replied within this time limit, the client's certificate will be rejected. |
| ssl_ocsp_max_response_age | <p>If an OCSP response's "thisUpdate" field is older than the number of seconds specified by this setting, the response will be considered invalid. If set to 0 (zero), the "nextUpdate" field of the response will be used to determine whether it has expired or not.</p> <p>If the time specified in the "nextUpdate" field of the response has passed, the response is considered invalid regardless of this setting.</p> |
| ssl_ocsp_time_tolerance | <p>If the OCSP responder and Traffic Manager's clocks differ slightly then the times specified in the "thisUpdate" and "nextUpdate" fields of a response might cause the Traffic Manager to consider it invalid. If the responder's clock is a few seconds faster than the Traffic Manager's clock, for example, the "thisUpdate" field of a response might appear to the Traffic Manager to be in the future.</p> <p>This setting allows you to specify the number of seconds to permit for clock differences.</p> |

The following OCSP responder settings are provided on a per-issuer basis. These allow you to specify different settings for certificates signed by particular issuers in the Certificate Authorities catalog.

Select a certificate authority in the **Add Issuer Specific Settings** section to add settings for that issuer. If the Traffic Manager receives a client certificate with an issuer that is not configured explicitly, the **Default Settings** will be used.

| Setting | Description |
|------------|--|
| OCSP check | This setting is used to enable and disable OCSP checks for the issuer. Selecting 'Always' will cause remote connections to be dropped when an appropriate OCSP responder URL cannot be determined. |

| Setting | Description |
|-----------------------------|--|
| Use AIA for URL | Issuers can embed an OCSP responder URL into their client certificates using the X.509 Authority Information Access extension. If this setting is enabled, and the extension is available, the Traffic Manager will use it. Otherwise it will use the Fallback URL . |
| Fallback URL | If the responder URL cannot be determined by other means, this URL is used. |
| Request signing certificate | OCSP requests can be signed so the responder can identify and authenticate the source of the request. You can select a certificate uploaded to the SSL Certificates catalog to sign the request, choose to use the certificate configured under Default Settings, or disable request signing. |
| Use nonce extension | <p>A unique sequence of data can be added to OCSP requests and responses to ensure an attacker cannot re-send a "good" OCSP response after a client certificate is revoked. When using the nonce extension you can require the responder to always return a nonce by using 'strict' mode. Otherwise the Traffic Manager will accept the response if it does not contain the nonce.</p> <p>Using this extension stops the responder from pre-generating responses to improve performance. Additionally, not all OCSP responders support this extension. If this is the case, a responder may return an 'unauthorized' response.</p> |
| Responder certificate | <p>OCSP responses are signed by the responder to prove they are genuine. You can select a specific certificate that responses should be signed by, from those listed in the SSL Certificate Authorities catalog.</p> <p>You can instead configure the system to expect the response to be signed by the issuer's certificate by selecting Issuing Certificate.</p> <p>Alternatively, you can select Signed by issuing certificate. This means the certificate must either be the issuer's certificate itself, or be signed by it and have the "id-kp-OCSPSigning" marker in its extendedKeyUsage extension, and also have the id-pkix-ocsp-nocheck extension.</p> |

SSL Session Resumption

An SSL session can be defined as the details that allow a secure channel to be (re-)established between two parties – generated by a process (handshake) designed to establish the security properties required for that channel, including the secret from which all cryptographic keys used by the connection are derived. Both client and server store those details, and the server ascribes an identifier (session ID) to those details for both parties to use when referring to that specific session. If the SSL TCP connection is terminated and the client subsequently reconnects, the client can present this session ID to signal to the server that it wants to resume the previous SSL session, using the cached encryption parameters.

The Traffic Manager allows session resumption for all supported SSL/TLS versions.

The Traffic Manager manages two SSL session ID caches:

- When it is acting as an SSL server (in other words, using virtual servers with “SSL Decryption” enabled)
- When it is acting as an SSL client (in other words, using pools with “SSL encryption” enabled or when TrafficScript rules make outgoing https requests)

To modify the size and expiry time of these caches, click **System > Global Settings > SSL Configuration**. Update the settings `ssl!cache!size`, `ssl!cache!expiry`, `ssl!client_cache!size`, and `ssl!client_cache!expiry` for the server and client caches respectively.

To monitor the behavior of the SSL Session ID Cache, plot cache data items on the Current Activity graph, or monitor these values using SNMP. To use the Current Activity graph, click **Activity > Current Activity**. Then, select and plot cache data items on the graph by clicking **Change data**. From the list of values, expand **Cache values > SSL Session ID Cache** and select the desired cache data items. To update the graph, click **Apply**.

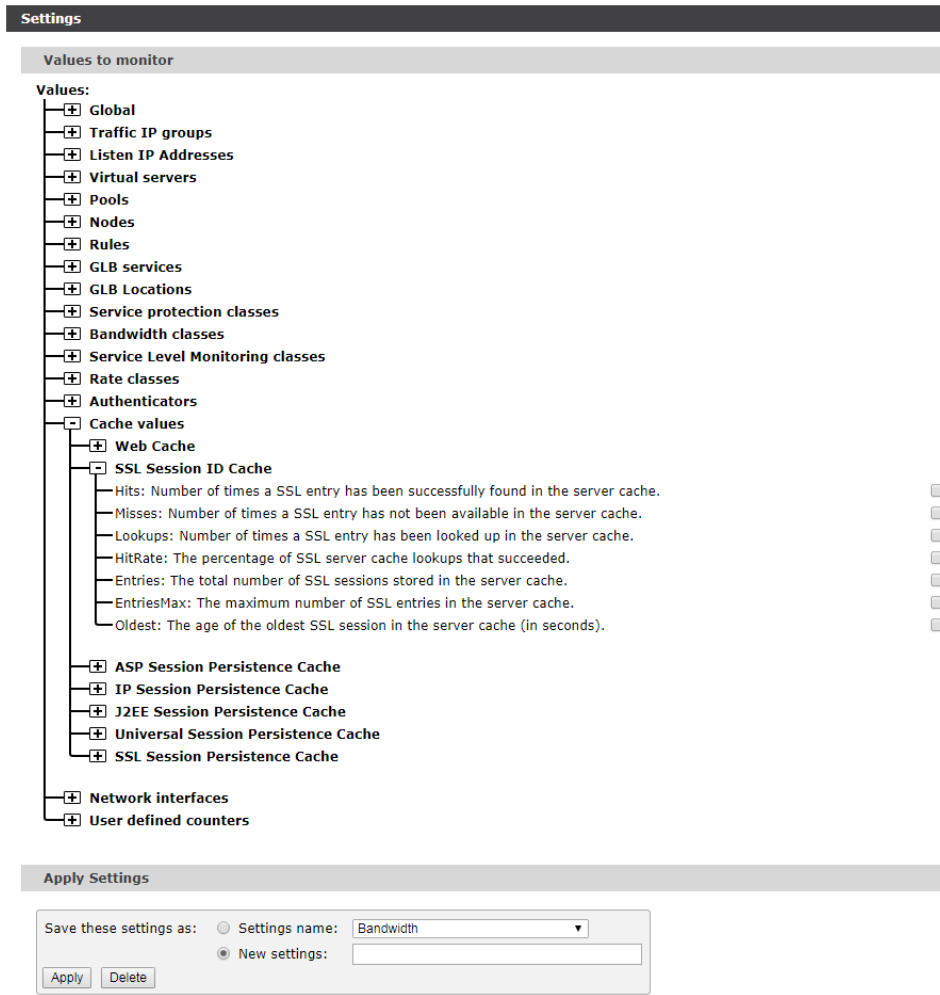

If the cache is full (comparing **Entries** with **EntriesMax**) and the **Oldest** value is significantly lower than the configured expiry time, it is likely that your cache is too small and the Traffic Manager is expiring cache entries too early. Consider increasing the cache size in **System > Global Settings > SSL Configuration**.

RFC 5077 (Transport Layer Security (TLS) Session Resumption without Server-Side State) introduced “session tickets” into versions of TLS earlier than 1.3. For TLSv1.3 onwards, the Traffic Manager additionally supports the more general definition of session tickets from RFC 8446 (TLSv1.3), which now fulfill the same function as both the earlier session tickets and session IDs.

Session tickets are a mechanism whereby SSL sessions can be resumed without the requirement for the server to store any state. The server instead uses a (symmetric) private key to encrypt the session information into a session ticket. All clients and network intermediaries not party to the private key cannot decrypt the contents of the ticket.

Rather than giving the client a short session ID, the server sends the client the longer session ticket. The client stores this session ticket instead of a session ID and presents it when it wants to resume the session. Provided the private key used to encrypt the ticket is still available, the server then decrypts the ticket, extracts the session information, and resumes the session with the client.

This scenario has the following advantages:

- The memory requirements for an SSL server to support session resumption are reduced.
- When multiple SSL servers act together in a cluster, if they share the ticket key, a session that was created on one server can be resumed against another server in the cluster without needing all session information to be shared between all cluster members.

The Traffic Manager supports TLS session tickets both when it is acting as a server and when it is acting as a client. When acting as a client, the session ticket is entered into the client session cache in place of a session ID, and the ticket is used to resume the SSL session instead of a session ID.

When acting as a server, the Traffic Manager must ensure that the keys used for encrypting tickets are changed sufficiently often to minimize the chances of a key becoming compromised, and to limit the damage done if one of the keys were compromised. To achieve this, the Traffic Manager automatically generates and rotates the keys used for ticket encryption.

The Traffic Manager maintains a database of historic ticket keys, each with a unique identifier. Each session ticket begins with a ticket key identifier, so when a session ticket is received by the Traffic Manager, it is able to locate the key used to encrypt that session ticket. If the Traffic Manager finds the ticket key in its database, it decrypts the session ticket and resumes the session (provided the session is valid).

Where multiple Traffic Managers join together as a cluster, the database of ticket keys is replicated across all cluster members. Each Traffic Manager in the cluster uses separate keys to encrypt the session tickets that it generates, with all current and historic keys being added to the centralized database shared between cluster members. In this way, an SSL session ticket from a client can be decrypted and resumed by any Traffic Manager in the cluster.

To configure the behavior of session tickets when the Traffic Manager is acting as an SSL server, click **System > Global Settings > SSL Configuration**. The following table describes the configuration settings available:

| Setting | Description |
|---------------------------------|--|
| ssl!tickets!ticket_key_rotation | The time, in seconds, after which ticket keys are renewed. The previously used key is added to the database. |
| ssl!tickets!ticket_key_expiry | The time, in seconds, after which ticket keys are deleted from the database. |
| ssl!tickets!ticket_expiry | The total time, in seconds, after which a session ticket is considered expired. Any session resumption requests presented to the Traffic Manager using a ticket older than this value are refused. |

To fully disable automatic key generation and rotation of ticket keys, use the "ssl/ticket_keys" resource in the Traffic Manager REST API. For more details, see the *Pulse Secure Virtual Traffic Manager: REST API Guide*. Ivanti recommends this procedure for advanced users only, with consideration for the following points:

- Ticket keys must be generated with a cryptographically strong random number generator. They must not be derived from static information like MAC addresses or serial numbers of servers.
- Ticket keys must be stored only for as short period of time as possible; if a ticket key is compromised, the forward secrecy of connections made using tickets encrypted with that key is also compromised. In particular, ticket keys should not be recorded in log files, and so on.
- When ticket keys are transmitted over a network link, they should be transmitted using ciphers that provide perfect forward security, such as ciphers using Diffie-Hellman or Elliptic Curve Diffie-Hellman key exchange algorithms.

TLSv1.3 replaces both session IDs and session tickets with a new style of session resumption (which offers improved security properties over the earlier forms). A TLSv1.3 session ticket is explicitly permitted to be either a "database lookup key" (similar to a session ID) or "a self-encrypted and self-authenticated value" (similar to a pre-TLSv1.3 session ticket).

By applying the configuration described in this section to decide whether to store a session/send a session ticket, or resume a session, the Traffic Manager considers the following actions equally based on the TLS version:

| TLSv1.2 and Earlier | TLSv1.3 Onwards |
|--|--|
| Saving a pre-TLSv1.3 session to the session cache and sending a session ID to the client | saving a TLSv1.3 session to the session cache and sending a ticket containing the lookup key |

| TLsv1.2 and Earlier | TLsv1.3 Onwards |
|--|---|
| Looking up a session from a pre-TLsv1.3 session ID | looking up a session from a ticket containing a lookup key |
| Generating/parsing a pre-TLsv1.3 session ticket | generating/parsing a TLsv1.3 encrypted ticket The same ticket encryption keys are used for pre-TLsv1.3 and encrypted TLsv1.3 session tickets |

OCSP Stapling Cache

The Traffic Manager maintains a cache of OCSP responses for server certificates used by virtual servers that have **ssl_ocsp_stapling** enabled.

In the **System > Global Settings > SSL Configuration** section of the Admin UI, you can configure the Traffic Manager's OCSP response caching behavior:

- Set the size of the cache with **ssl!ocsp_stapling!mem_size**.
- Use **ssl!ocsp_stapling!default_refresh_interval** to control how long the Traffic Manager waits before making a new OCSP request, if no response with a "nextUpdate" time in the future is available in the cache.
- Use **ssl!ocsp_stapling!maximum_refresh_interval** to define the maximum interval that can elapse between OCSP requests. After a valid OCSP response is received, the next update is made this many seconds in the future, unless the "nextUpdate" time in the OCSP response is sooner.
- The Traffic Manager provides a signature verification option **ssl!ocsp_stapling!verify_response**. Set this to Yes to force the Traffic Manager to verify the signatures and validity periods of OCSP responses before using them for stapling. If verification fails, the Traffic Manager never uses the response for OCSP stapling.

- An OCSP response has a validity period defined by two fields in the OCSP response: "thisUpdate" and "nextUpdate". When **ssl!ocsp_stapling!verify_response** is enabled, responses outside this period are not cached and therefore not stapled. In some environments, clock skew might be a concern. This can cause the local current time to appear to be earlier than the "thisUpdate" field in the OCSP response, causing an incorrect validity failure. Use the **ssl!ocsp_stapling!time_tolerance** setting to define an allowed time margin (in seconds) outside this interval when the Traffic Manager should still consider responses to be valid.

SSL Encryption

A pool can perform SSL encryption before it sends traffic to a back-end SSL server. When enabled, SSL encryption can use additional CPU resources on the Traffic Managers that perform the encryption.

To enable SSL encryption for a pool, go to **Pools > Edit > SSL Settings**.

You can configure the following options:

| Setting | Description |
|-----------------------|---|
| ssl_encrypt | Set to "Yes" to enable SSL encryption to the back-end nodes. |
| ssl_send_close_alerts | Set to "Yes" to send an SSL/TLS "close alert" when initiating a socket disconnection. |
| ssl_support_<version> | Set to "Enabled" to allow this pool to use the designated version of SSL or TLS for connections to back-end nodes. Choose Use the global setting to force the Traffic Manager to use instead the equivalent global value set in System > Global Settings > SSL Configuration . |
| ssl_cipher_suites | Specify the list of ciphers available for secure communications to back-end nodes. Use a space-, comma-, or colon-separated list (in order of preference). Leave the list blank to force the Traffic Manager to use instead the equivalent global value set in System > Global Settings > SSL Configuration . |
| ssl_client_auth | If the back-end server requires client certificate authentication, enable this setting to configure the Traffic Manager to select an appropriate certificate from its local Client Certificates catalog. To configure your Traffic Manager with client certificates, see Catalogs > SSL Catalogs > SSL Client Certificates catalog . |

| Setting | Description |
|------------------------------|---|
| | <p>The server sends to the client a list of Certificate Authorities that it trusts, and by default the Traffic Manager chooses the first client certificate it finds that is signed by one of the server's trusted CAs. To explicitly control which certificate is used, set "ssl_fixed_client_certificate".</p> <p>If a server sends an empty list of CAs, the Traffic Manager does not choose a client certificate unless "ssl_fixed_client_certificate" is set.</p> |
| ssl_fixed_client_certificate | <p>The name of an entry in the SSL Client Certificates catalog, used by the Traffic Manager whenever a server in this pool requests a client certificate. In this case, any list of trusted CAs in the request is ignored.</p> <p>This setting is applicable only if "ssl_client_auth" is enabled.</p> |
| ssl_server_name | <p>Set to "Yes" to cause the Traffic Manager to try the TLS 1.0 "server_name" extension, which can help the back-end node to provide the correct certificate. If you enable this setting, the Traffic Manager is forced to use at least TLS 1.0.</p> |
| ssl_strict_verify | <p>As a protection against man-in-the-middle attacks and server spoofing, the Traffic Manager can validate the SSL certificates used by back-end servers against the CA's in the catalog. Set to "Yes" to instruct the Traffic Manager to reject connections to servers if their certificates have expired, or if the certificate's Common Name does not match the node's IP address, hostname, or one of the names listed in "ssl_common_name_match", or if a CA in the catalog has not signed it.</p> |
| ssl_common_name_match | <p>A list of hostnames or IP addresses that the Traffic Manager accepts as Common Name in the certificate presented by the server.</p> |

Click **Update** to save your changes.

Preserving IP Addresses with SSL Forwarding

When the Traffic Manager forwards HTTP requests, it can optionally insert a header named X-Forwarded-For into the request so that downstream servers can determine the correct source IP address of the request. If the Traffic Manager decrypts an HTTPS request, it can also insert the X-Forwarded-For header into the request, even if it then re-encrypts the request.

However, if the Traffic Manager forwards an SSL request without decrypting and re-encrypting it, it cannot modify the data inside. This configuration is used with a loopback virtual server, whereby the connections are load-balanced across a cluster of Traffic Manager systems for decryption. In this case, you may use the **ssl_enhance** setting in the pool to add a proprietary header to the SSL connection that contains key connection data that is not preserved, i.e. source IP and port and destination IP and port.

The Traffic Manager system that receives the "enhanced" SSL connection must be configured with the **ssl_trust_magic** setting in the SSL decryption settings of the virtual servers. This setting will cause the Traffic Manager to strip out the proprietary header, and recognize the correct connection data – source IP and port, and destination IP and port.

Use of SSL Cryptographic Devices

The Traffic Manager software variant supports SSL hardware based on the RSA Security Inc. PKCS #11 Cryptographic Token Interface (Cryptoki), such as the Thales e-Security nShield Connect.

All Traffic Manager variants support the Microsoft Azure Key Vault service. Azure Key Vault is offered as a cloud based alternative to traditional hardware security modules. For Azure Key Vaults, observe the following conditions:

- The Traffic Manager supports using keys that are created by the Traffic Manager itself, or valid existing RSA keys migrated into the Azure Key Vault.
- The Traffic Manager supports "RSA-HSM" type keys. These keys are stored on secure hardware at the Azure Key Vault service.
- To create and use RSA-HSM keys, you must use a "Premium" service tier Azure Key Vault. For information and pricing for the available service tiers, see <http://azure.microsoft.com/>.
- In common with other secure hardware support, the Traffic Manager can use keys stored in an Azure Key Vault for SSL decryption (virtual servers) or SSL encryption (pools). The Traffic Manager cannot use stored keys for other purposes such as SSH or DNSSEC.
- If the Traffic Manager is configured to use FIPS mode (see [FIPS Validation in the Traffic Manager](#)), communications with the Azure Key Vault REST API operate in FIPS mode as well.
- To use the Azure Key Vault, the Traffic Manager's DNS must be able to resolve the hostnames of both the Azure Key Vault server and Microsoft's login server. The Traffic Manager must also be able to establish outgoing TCP connections on port 443. If your Traffic Manager system is firewall restricted, you must ensure your firewall is configured to allow this communication channel.



For instructions on setting up and managing an Azure Key Vault, see <http://azure.microsoft.com/en-us/documentation/services/key-vault/>.

Using an HSM device or Azure Key Vault service offloads SSL computation (the RSA private key decryption) from the Traffic Manager system's CPU onto the SSL cryptographic device to which you connect. Some PKCS#11 devices also provide hardware key management, so that the private key is stored securely on the hardware device and cannot be accessed directly without the correct authentication.

As RSA cryptographic operations being performed on an SSL cryptographic device or service are outside of the Traffic Manager FIPS 140-2 Cryptographic Boundary, you should independently ensure that your cryptographic device or service is sufficiently conformant to FIPS 140-2 for your requirements.



Some Traffic Manager variants, such as the virtual appliance, display a limited set of the following options based on the hardware and services supported for these variants.



Use of SSL devices might not improve the overall performance of your Traffic Manager system. Although such devices offload the RSA calculation from the main CPU cores, the overhead in communicating with the device is not negligible. The Traffic Manager is able to perform many thousands or tens-of-thousands of SSL calculations on general purposes CPUs. The primary benefit of many SSL devices is their ability to store the private key securely.

Configuring the Traffic Manager to Use an SSL Device

To configure the Traffic Manager to use an SSL device or service, click **System > Global settings** and then click **SSL Hardware Support**. Select the desired SSL device in **ssld!library**.

SSL Hardware Support

These settings control how cryptographic hardware devices (such as PCI cards or network devices) are used.

The type of SSL hardware to use. The drivers for the SSL hardware should be installed and accessible to the traffic manager software.

None
 Microsoft Azure Key Vault
 PKCS#11 (e.g. nCipher NethSM) ...

Location of PKCS#11 Library:
ssld!driver!pkcs11_lib:

The User PIN for the PKCS#11 token:
ssld!driver!pkcs11_user_pin:

Security token type:
ssld!driver!pkcs11_slot_type:

Security token label (required when multiple tokens available):
ssld!driver!pkcs11_slot_desc:

The Microsoft Azure Key Vault can be used to provide cryptographic services.

Whether or not the SSL hardware is an "accelerator" (faster than software). By default the traffic manager will only use the SSL hardware if a key requires it (i.e. the key is stored on secure hardware and the traffic manager only has a placeholder/identifier key). With this option enabled, your traffic manager will instead try to use hardware for all SSL decrypts.

ssld!accel: Yes No Default: No

The number of consecutive failures from the SSL hardware that will be tolerated before the traffic manager assumes its session with the device is invalid and tries to log in again. This is necessary when the device reboots following a power failure.

ssld!failure_count: Default: 5

The following table describes the settings available:

| Setting | Description |
|--------------|--|
| ssld!library | <p>Set to "Microsoft Azure Key Vault" to instruct the Traffic Manager to use an Azure Key Vault service. To connect to an Azure Key Vault, click "Connect to Microsoft Azure Key Vault".</p> <p>Set to "PKCS#11" to instruct the Traffic Manager to use generic PKCS compliant hardware such as the Thales e-Security nShield Connect.</p> <p>Additional settings for PKCS#11 are:</p> <p>ssld!driver!pkcs11_lib: The system location that the Traffic Manager should search for the PKCS#11 interface library. Leave this field blank for the Traffic Manager to search standard system locations instead.</p> |

| Setting | Description |
|--------------------|--|
| | <p>ssld!driver!pkcs11_user_pin: The PIN required to create a user session on the SSL hardware.</p> <p>ssld!driver!pkcs11_slot_type: The form of security token the Traffic Manager uses to protect the SSL private key:</p> <p>Operator Card Set: A physical smart card set with a suitable card reader plugged into the Traffic Manager. The smart card might require an optional user PIN.</p> <p>Soft Card: A file on disk that performs the same operation as a physical smart card arrangement. The file requires a user PIN.</p> <p>Module Protected: The cryptographic module alone protects the key, with no smart card or user PIN.</p> <p>ssld!driver!pkcs11_slot_desc: (token types "Operator Card Set" and "Soft Card" only) Use this setting to provide the identifying label or name for the card you are using.</p> |
| ssld!accel | Whether to use the SSL device defined on this page for all decryption operations. Set to "Yes" to force the Traffic Manager to use the SSL device for all operations. Set to "No" to mean the Traffic Manager only uses the SSL hardware when the private key is stored securely on it. |
| ssld!failure_count | The consecutive number of attempts that the Traffic Manager can make before assuming the session is invalid and trying to log in again (due to reboot, power failure, and so on). |

Verifying Correct Operation of SSL Devices

The **Diagnose** page displays the results of checks that the Traffic Manager can communicate with the SSL device. Any errors or warnings are indicated.

If you have configured the Traffic Manager to use an SSL device that supports hardware key management, you can then:

- Create new private keys (and corresponding public certificates) on the device using the Traffic Manager. Follow the procedure referred to in [Creating a New Self-Signed SSL Certificate](#) to create a new self-signed Server or Client SSL certificate, making sure to select the **Create private key on hardware** option that is present when a key-management device is configured.
- Manually install private keys and public certificates from the hardware on the Traffic Manager. Follow the instructions for your hardware device to extract an encoded version of the private key and the public certificate. Then install them on the Traffic Manager using the **Import Certificate** tool in the relevant SSL Server Certificates and SSL Client Certificates catalog.
- Migrate existing private keys from the Traffic Manager onto a newly connected SSL device. To move the key, use the "Migrate certificate to Hardware Security Module" section on the relevant certificate edit page.

ATTENTION

If an attacker has already obtained a copy of your private key, migrating it to an SSL device from the Traffic Manager does not constitute a guarantee that it is now protected. For the highest security, Ivanti recommends using keys generated on the SSL device itself.

The Traffic Manager verifies that it can access and use any hardware-managed keys, and indicates an error on the **System > Diagnose** page and the **Event Log** if any problems occur.



Although client certificates and corresponding private keys might be marked as unavailable on the **Diagnose** page and in the **Event Log**, the pool using them cannot be marked as having any problems because the Traffic Manager never knows what client certificate will be asked for until it connects to a back-end SSL node that requires one.

Using the Connect to Microsoft Azure Key Vault Wizard

To connect to an Azure Key Vault, click the **Connect to Microsoft Azure Key Vault** wizard link at **System > Global Settings > SSL Hardware Support**.

However, before you activate the wizard, first obtain the following information:

- **Azure Key Vault URL:** The URL of your designated Azure Key Vault. For example, "https://dev.vault.azure.net".
- **Client ID:** The Identifier (ID) of your user account in the Azure Key Vault.
- **Client Secret:** An alpha-numeric string representing the password of your user account.

- **A trusted Certificate Authority:** (Optional) To protect your connections to the Azure Key Vault from "man-in-the-middle" attacks, you can instruct the Traffic Manager to validate the identity of the SSL certificate used by the Azure Key Vault REST API. Obtain the trusted Certificate Authority that signed Microsoft's SSL certificates and store it in the Traffic Manager CA catalog prior to running the wizard.

For help obtaining this information, contact your support provider or see the Microsoft Azure Key Vault documentation at: <http://azure.microsoft.com/en-us/documentation/services/key-vault/>.

In common with other Traffic Manager wizards, the "Connect to Microsoft Azure Key Vault" wizard runs through a number of steps, each one providing a **Back** and **Next** button to navigate between them:

1. Introduction.
2. Enter the URL of your Azure Key Vault:

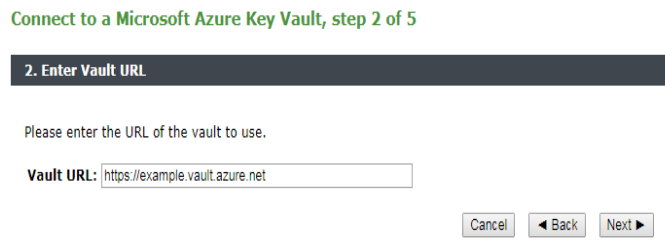

Connect to a Microsoft Azure Key Vault, step 2 of 5

2. Enter Vault URL

Please enter the URL of the vault to use.

Vault URL:

Cancel ◀ Back Next ▶

3. Enter your client credentials:

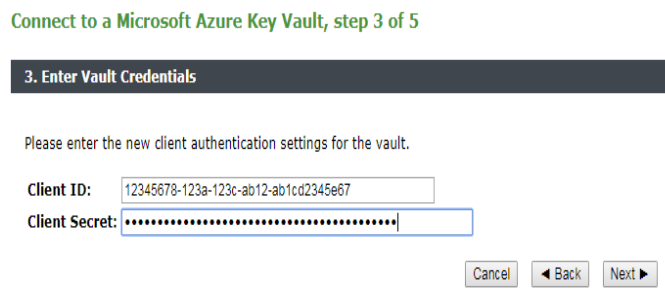

Connect to a Microsoft Azure Key Vault, step 3 of 5

3. Enter Vault Credentials

Please enter the new client authentication settings for the vault.

Client ID:

Client Secret:

Cancel ◀ Back Next ▶

4. Select "Yes" to instruct the Traffic Manager to verify the SSL certificate of the Azure Key Vault REST API, or select "No" to disable verification:

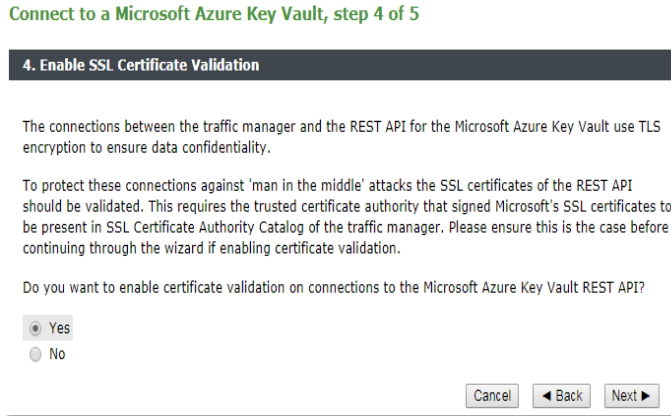

- Click **Finish** to connect to the Azure Key Vault using the settings shown.

If the Traffic Manager is successful, the SSL Hardware Support section updates to indicate the active Azure Key Vault connection.

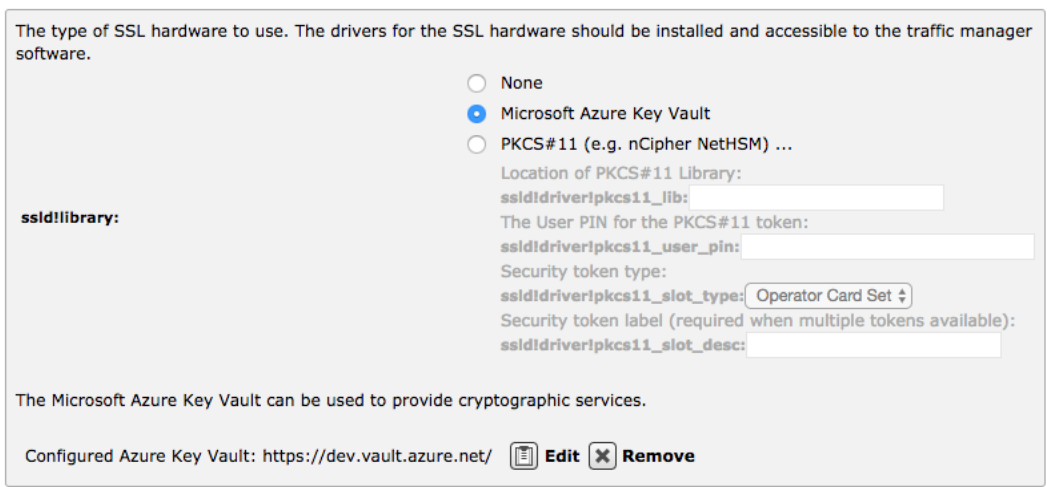



Click **Edit** to rerun the wizard with alternative settings, or click **Remove** to disconnect the Traffic Manager from the active Azure Key Vault.

Connection failures, warnings, and errors relating to Azure Key Vault are reported on the **Diagnose** page and in the **Event Log**.

Identifying Keys and Certificates Stored on a Secure Device

After you have successfully connected to secure hardware or an Azure Key Vault, you can use the key and certificate files from the device as you would any other key pair (including editing the certificate). Provided the device is operating normally, the Traffic Manager delegates all cryptographic operations that require the private key to the device. In the Admin UI, the Traffic Manager identifies keys as being stored on secure hardware, or in the Azure Key Vault, as shown:

Which SSL certificate should this virtual server use?

| certificate: | Name | Site (CN) | Signed by (Issuer) | Expires |
|---|----------------------------|----------------------|--------------------|-------------|
|  | example | example.cam.zeus.com | (self-signed) | 02 May 2007 |
|  | (no certificate specified) | | | |

 = private key stored on secure hardware

Health Monitoring

This chapter describes the Traffic Manager's health monitoring capabilities, used to monitor server nodes for correct operation, to raise alerts, and to route around failed nodes when an error is detected.

Which Nodes Are Monitored?

The Traffic Manager uses two methods to monitor the correct operation of nodes: passive monitoring (checking the status of a node when it is used) and health monitoring (additional tests that are run against a node on a periodic basis).

Passive monitoring tests are only performed against nodes that are actively in use.

Health monitors are executed against all of the nodes in a pool. They are only run against pools that are in use in the following ways:

- Pools that are configured as the default pool for a virtual server.
- Pools that are explicitly referenced by name in a TrafficScript or RuleBuilder rule, either by the `pool.select()` or `pool.use()` functions.
- Pools that are configured as the "failpool" for a pool that is in use.

If a pool is not referenced by the Traffic Manager configuration in this way, it is considered to be "not in use" and is not monitored using health monitors. Any failures of nodes will not be detected.



Pools must be explicitly referenced by name when they are used in a TrafficScript rule. By default, referencing by a variable (`pool.use($name);`) or any other means is not permitted by the Traffic Manager.

If you enable the setting **trafficscript!variable_pool_use** (in **System > Global Settings**), you can use variables for pool names. If this setting is enabled, the Traffic Manager will execute health monitors against all of the pools you have configured, not just the ones that are clearly in use.

Using Nodes in Multiple Pools

The same node (IP address and port) may be referenced in several different pools. If a node has failed in one pool, it is not used by the load balancing or session persistence decisions. However, that node may be used in other pools until the passive monitors and health monitors assigned to those pools report a failure.

Example

Your Web application has 4 back-end servers (nodes). Each node hosts the same dynamic content and static content. If the dynamic content on a node fails (for example, the Java servlet crashes), you might still want to use that node for other static content:

- Create two pools named "Dynamic" and "Static", each containing all 4 nodes.
- Create a rule that uses pool "Dynamic" for dynamic content (Java Servlets, PHP and ASP files etc) and uses pool "Static" for all other content.
- If a node fails in the "Dynamic" pool and fails to send a valid HTTP response, the passive monitoring used by that pool determines that node has failed. No more traffic from the "Dynamic" pool is sent to that node. However, the "Static" pool continues to send traffic to that node, as long as it returns valid HTTP responses for requests from the "Static" pool.
- For more fine-grained detection of errors, you can assign different health monitors to each pool. For example, the health monitors for the "Dynamic" pool can send synthetic PHP or ASP requests. If these monitors fail, the node is considered to have failed in the "Dynamic" pool, but not in other pools.

Passive Health Monitoring

A pool performs a set of checks every time it attempts to send a request to a node; this process is referred to as Passive Monitoring:

- The Traffic Manager attempts to connect to a node; if the connection is refused, or is not established within the **max_connect_time** setting (default 4 seconds), the request is considered to have failed.
- The Traffic Manager writes the request data down the connection; if the connection is closed prematurely, or if the beginning of a response is not received within **max_reply_time** seconds (default 30 seconds), the request is considered to have failed.
- For SSL only: if the SSL handshake to the node fails, the request is considered to have failed.



The **max_connect_time** and **max_reply_time** settings are properties of the **Protocol Settings** page in a pool configuration. For more information, see [Protocol Settings](#).

Retrying Failed Requests

If these checks fail, the pool might try the request against a different working node, and can try every node in the pool before abandoning the request. The actual behavior is determined by the “idempotent” status of the request.

By default requests are assumed to be idempotent, in other words they can be safely retried multiple times without undesired side effects. An exception to this is any request received through a virtual server using one of the generic-type protocols (“Generic Client First”, “Generic Server First”, “Generic Streaming”). In order to be idempotent by default, an end-point to the request must first be defined¹ in order for failure to be measured and retries to be triggered.

RFC 2616 defines some HTTP requests as non-idempotent² (for example, they can cause a transaction to take place or change state on the server). The Traffic Manager follows these recommendations and treats HTTP GET, HEAD, PUT, DELETE, OPTIONS and TRACE methods as idempotent; all other requests are considered non-idempotent.

To summarize:

- **Idempotent (no side effects):** The Traffic Manager retries these requests against other believed-to-be working nodes, and can try every node in the pool before abandoning the request.
- **Non-idempotent (side effects):** The Traffic Manager only retries a non-idempotent request if it failed to open a TCP connection to the failed node.



When the Traffic Manager establishes a TCP connection, it immediately writes the request data down that connection. The Traffic Manager is not able to determine whether or not the node has received the request data and begun processing it. Therefore, non-idempotent requests are only retried if the connection could not be established in the first place.

You can override the idempotent/non-idempotent decision made by the Traffic Manager by using the `request.setIdempotent()` and `http.setIdempotent()` TrafficScript functions to indicate to the Traffic Manager that a particular request should be considered safe to retry.

¹Achieved via TrafficScript, using functions such as `request.endsWith()` or `request.endsAt()`.

²<http://www.w3.org/Protocols/rfc2616/rfc2616-sec9.html>.

Node Failures

The Traffic Manager infers that a node has failed if connections to that node fail consistently, with **node_connection_attempts** (default 3) failures in a row with no intermediate successful transactions.

If a node has been deemed to have failed, it is not used for at least **node_fail_time** seconds (default 60 seconds), after which it is tentatively used to determine if it has recovered by periodically attempting to send it idempotent requests from the live service traffic. If the request fails, it can be retried against another, working node. Where all nodes in the pool have failed, the Traffic Manager immediately sends traffic to a recovered node regardless of the **node_fail_time** setting.



To configure **node_connection_attempts** and **node_fail_time**, use the **Pools > Edit > Protocol Settings** page.

To learn more concerning the cause of node failures, enable **log!server_connection_failures** in **Virtual Servers > Edit > Error Logging**. This facility can help provide more useful log information regarding the actual reasons for your node failures. For more details, see [Handling Errors](#).



A node that has been marked as having failed by passive monitoring can recover only if it responds to live service traffic. It cannot be recovered by an active Health Monitor.

Enabling and Disabling Passive Monitoring

Passive Monitoring is used by default, but can be disabled on a per-pool basis using the **passive_monitoring** setting in the **Monitors** section of a pool configuration. If this setting is disabled, you should ensure there are suitable Health Monitors configured otherwise failed requests are not detected and subsequently retried.

Overview of Health Monitors

In addition to the inferences from passive monitoring, a pool may be configured with explicit Health Monitors that perform periodic tests and verify the correct operation of each node. By using health monitors, the Traffic Manager can detect failures even when no traffic is being handled.

The tests are performed at configured intervals against each node in a pool; if they fail sufficiently often, that node is marked as unavailable, and the Traffic Manager will stop sending traffic to that node. Pool-wide monitors just test a single machine and can be used to indicate that an entire pool is down.



A node that has been marked as having failed can be recovered only by the monitor that marked it as having failed.

The monitors are held in the Monitors Catalog and can be applied to any pool. Each performs a specific test. These range from simple tests, such as pinging each node, to more sophisticated tests which check that the appropriate port is open and the node is able to serve specified data, such as your home page.

The Monitors Catalog



Some monitor types use regular expressions. Before continuing, read and understand the security considerations in [Using Regular Expressions](#).

Setting Up a Monitor

To access the Monitors catalog, click **Catalogs > Monitors** in the Admin UI.

The Traffic Manager contains a number of preset monitors. Some of these deal with generic TCP client-first or server-first protocols, and others are protocol-specific. For instance, the built-in "Full HTTP" monitor requests a specified page from a Web server and looks for a suitable status code in the response.

All monitors have the following configurable settings:

| Setting | Description |
|----------|--|
| delay | Monitors are executed repeatedly against each node. Once a monitor has completed or times out, the Traffic Manager pauses for this configured period of time before trying the monitor again. |
| timeout | If a monitor fails to complete within this timeout period, it is aborted and judged to have failed. |
| failures | A monitor may occasionally fail for unpredictable and unrepeatable reasons, such as a brief network glitch. This setting indicates how many times a monitor must fail consistently before the monitored node is judged to have failed. |

| Setting | Description |
|---------|---|
| verbose | This setting enables verbose monitor logging in the error log. It is useful for testing a monitor, but should not be used in a product system or for a long period of time because it can fill up the error log file. |

You can edit the built-in monitors: click the name of one, and modify the timings, failure conditions, and logging, along with any other monitor-specific settings (such as the Web page to request). Click **Update** to commit your changes.

To create a copy of the built-in monitor under a new name, click **Copy Monitor**.

Built-in Health Monitors

The Traffic Manager contains a number of predefined monitors in the Monitors catalog. These built-in monitors perform standard tests for various protocols.

Basic Monitors

Basic Monitors perform simple tests against a node. For example:

- **Ping:** The ping monitor performs ping requests against each node. It will fail if no response is received.
- **Connect:** This performs TCP connects to the node. Its purpose is to ensure that a server is listening on the port, and will accept traffic. This monitor can cause some programs (such as `exim`) to output errors; in this case a more protocol specific monitor should be used.

Advanced Monitors

Advanced monitors perform more complex request and response tests against a node. These monitors are used as building blocks for other monitors, and can use SSL to connect and transfer the request and response. For example:

- **Client First:** This is a monitor based on the TCP transaction monitor. It will send some data to the node, and match the response against the supplied regular expression. In order to use it, the data to send (the **write_string**) must be configured.

- **Server First:** This monitor can be used to check services where the server writes data first. It will connect to the node, and check that the server returns some data. This monitor can easily be altered to check for specific data being returned by the server.
- **Full HTTP / HTTPS:** This monitor can be used to perform HTTP or HTTPS requests. The host header, URL and authorization parameters can all be configured.

The response return code is matched against the value in **status_regex**. For example, if you are expecting a 200 return code, set **status_regex** to "^200\$". Alternatively, use "[234][0-9][0-9]\$" to accept errors from 200 to 499.

The response body is matched against the optional setting **body_regex**.

If the pool that an SSL monitor is assigned to has **ssl_server_name** enabled, the monitor sends a Server Name Indication (SNI) TLS extension with the name of the node to the back end.

Protocol-Specific Monitors

Protocol-specific monitors perform specific tests against a node. These include:

- **DNS:** This is an example of a program monitor. It will run a program (ZEUSHOME/zxtm/conf/scripts/dns.pl) that makes a DNS request to the node, and validate the address returned.
- **FTP:** This monitor is based on the TCP transaction monitor. It will make a simple FTP connection, and check that the server is responding correctly. It only checks that the banner is returned by the server, and does not authenticate.
- **POP:** This monitor is based on the TCP transaction monitor. It will make an initial connection to the node, and check that the correct POP banner is returned.
- **SMTP:** This is identical to the POP monitor, except that it checks for the SMTP server banner being returned.
- **Simple HTTP and HTTPS:** These monitors request the home page from each node. They check that the response code is a 2xx, 3xx, or 4xx response code, and indicate a failure of not.
- **RTSP:** This monitor will send an RTSP DESCRIBE request to the server. It will check for a 2xx, 3xx or 4xx response or report a failure if one is not received. Note that some RTSP servers require the presence of a path in such a DESCRIBE request, in which case you should enter one in the `rtsp_path` setting. The protocol specific additional settings for RTSP are:

- **rtsp_path**: the path to be used in the DESCRIBE request. This is the path to the multimedia file being streamed.
- **rtsp_status_regex**: The status code regular expression that the RTSP response must match.
- **rtsp_body_regex**: The regular expression that the RTSP response body must match.
- **SIP (UDP)**: This monitor will send a SIP OPTIONS request to the server with Max-Forwards set to 0. It will check for a 2xx, 3xx or 4xx response and report a failure if one is not received.
 - **sip_status_regex**: The status code regular expression that the response must match.
 - **sip_body_regex**: The regular expression that the SIP response body must match.
 - **udp_accept_all**: Should this monitor accept responses from any IP and port?
- **SIP (TCP)**: This monitor uses the same request as the SIP-UDP monitor but sends it over a TCP connection.

Custom Health Monitors

The main Monitors catalog page has a “Create New Monitor” section, where you can create a new monitor. There are several options for the underlying type:

| Monitor Type | Description |
|------------------|--|
| TCP Transaction | This performs a TCP transaction with the target machine, with an optional string of data to write to the connection. It can look for a specified regex in the response. |
| Ping | This pings the target machine at specified intervals. |
| External Program | This runs an external program, whose file path on the Traffic Manager machine you specify. It sends two built-in arguments, port and ipaddr , along with any others specified. An exit code of 0 is classed as a success; a code other than 0, or a timeout, is a failure. ZEUSHOME/zxtm/conf/scripts contains your custom monitor executables; you can see an example there. |

| Monitor Type | Description |
|--------------|--|
| HTTP | This sends an HTTP request to the target server, optionally using SSL, with specified parameters such as host header and the URL path to use. It searches for a status code regex in the response code, and a regex against the response body data. |
| TCP Connect | This makes a TCP connection with the target machine, to check that the appropriate port is open. |
| RTSP | This issues an RTSP DESCRIBE request to the target server, with the specified rtsp_path parameter. It looks for a status regex in the response, and a regex against the response body data. |
| SIP | This sends a SIP OPTIONS request to the target server using the specified transport protocol. It searches for the status regex in the response code and the body regex in any body of data that was received. A failure is reported if either of these do not match. |

When you have chosen the basic settings for your monitor, click **Add Monitor**. You can click the name of the monitor to edit it.²

It is possible to build sophisticated custom monitors, using either the "TCP Transaction" or "HTTP" monitor templates. For example, a pair of HTTP-based monitors could test the secure part of a Web site to verify that:

- A request with a valid username and password receives a valid 200 response.
- A request with an incorrect username and password receives a 401 or 403 error response.

"TCP Transaction" monitors are useful building blocks for nodes that use other protocols.

For more sophisticated tests, a monitor can run an external program or script. "External Program monitors" are described in [External Program Monitors](#).

Per-Node and Pool-Wide Monitors

Monitors fall into two categories: per-node and pool-wide. A per-node monitor tests the health of each node in the pool. A pool-wide monitor performs tests on one machine, which influences the health of the entire pool. For example, a mail server pool might keep its data on an NFS server, which each of your back-end servers accesses. A pool-wide monitor could test this server. If it fails, none of the back ends can retrieve the data so the whole pool is deemed to have failed.

You can choose whether your monitor should be per-node or pool-wide. If it is pool-wide, you must specify a machine (and possibly port) for the monitor to test, such as an NFS server used by the pool.

Using Health Monitors

Applying a Monitor to a Pool

To apply a monitor to a pool, click **Services > Pools**. Then click the name of a pool to edit it.

Click **Health Monitoring** to choose the monitors used by the pool. You can add a new monitor from the drop-down list, clicking **Add Monitor** when you have finished. To change settings for a monitor attached to your pool, click the **Edit In Catalog** link against it.



A monitor sending test requests will increase the load on a pool, albeit by a small amount. You should ensure that your back-end servers can handle the traffic produced by the monitors, to avoid a DoS failure.

External Program Monitors

An external program monitor can be written in any language. The Traffic Manager passes command-line arguments to the executable:

```
domonitor --ipaddr=<machine_to_monitor> \  
          --node=<nodename> \  
          --port=<port_to_monitor>
```



The ipaddr, node, and port arguments are always passed to an external program monitor. The node argument is the hostname part of the node, as configured in the pool, and the ipaddr is the corresponding IP address.

You can also specify additional arguments for the monitor, which may be useful if you are using the same executable for several different monitoring tasks. Use the “Program Arguments” section of the **Edit** page for the monitor in question.

For example, if you configured two additional arguments (named “regex” and “interface”) and gave then appropriate values on the **Edit** page, the monitor executable would be invoked as follows:

```
domonitor --ipaddr=<machine_to_monitor> \  
  --node=<nodename> \  
  --port=<port_to_monitor> \  
  --interface=<interface_value> \  
  --regex=<regex_value>
```

A successful monitor should exit with an exit code of 0; a timeout or non-zero exit code is interpreted as failure, and in this case the contents of STDERR are written to the Event Log.

When you develop and test a monitor executable or script, you can easily run it from the command line, providing arguments in the format described above. Your monitor can emit debugging information to STDOUT.

When the monitor is used by the Traffic Manager, you can enable verbose mode. If the monitor is called in verbose mode, anything printed to STDOUT by the executable is written to the Event Log; verbose mode can be toggled on the monitor’s Edit page.

Uploading Monitors to the Traffic Manager

To upload, manage, and delete monitors on the Traffic Manager, click **Catalog > Extra Files > Monitor Programs**.

Catalogs:

| | | | | | | | | | |
|-----------|------------|--------------|-----------|------|-----------------|-------------------|--------------------------------|----------------|----------|
| Locations | DNS Server | GLB Services | Rules | Java | Web Accelerator | Monitors | SSL | Authenticators | Kerberos |
| SAML | Protection | Persistence | Bandwidth | SLM | Rate | Cloud Credentials | Extra Files > Monitor Programs | | |

Monitor Programs Unfold All / Fold All

Manage the programs that can be executed by custom external program monitors by uploading, downloading and deleting them.

- ▶ ✓ dns.pl
- ▶ ✘ dns_port.pl

Upload Monitor Program

Upload a monitor program from your local machine. It will be added to the list above.

File name: No file chosen

Monitors Catalog

 Monitors Catalog

Writing Monitors in Perl

If you choose to write your monitor in Perl, use the helper module, `Monitor.pm`, included with your Traffic Manager. This includes a `ParseArguments()` function, as well as functions to exit with success or failure and to write out logs.

```
use Zeus::ZXTM::Monitor qw( ParseArguments
    MonitorWorked
    MonitorFailed
    Log );

%ARGS = ParseArguments();

Log( "Running test" );
if( do_test( $ARGS{ipaddr}, $ARGS{port} ) ) {
    MonitorWorked();
} else {
    MonitorFailed( $error_message );
}
```

For more information on **Monitor.pm**, use the following command:

```
$ perldoc ZEUSHOME/zxtm/lib/perl/Zeus/ZXTM/Monitor.pm
```

Service Protection

This chapter explains some of the risks associated with Internet hosting, and how to use the Traffic Manager to mitigate those risks to your services.

Classes of Risk

Denial of Service

A “Denial of Service” (DoS) attack is characterized by a malicious attempt to prevent legitimate use of a service. This could take the form of attempting to flood a network, or disrupt connectivity between machines. It may be designed to consume the resources normally available for specific users or applications, for example exhausting the available CPU, bandwidth or storage of a server or cluster of servers.

DoS attacks are based around exploiting design weaknesses, flaws in the operating system, or services with unbounded access to a resource such as CPU time, disk or memory. For example, a malicious attacker may find a way to craft a request to a database-driven Web site that requires extremely intensive SQL operations to complete. This could effectively deny access to the database for the duration of the query.

DoS attacks that are delivered through exposed services such as websites are the most common class of risk. The Traffic Manager is designed to assist in mitigating the effects of such attacks, or preventing them altogether.

Web Worms and Viruses

Vulnerabilities in operating systems have led to many Internet “worms” which propagate by installing themselves, using the weakness as a point of entry. For example, a worm can install a payload sufficient to propagate itself further. Worms also affect desktop PCs. The frequency of this class of attack is increasing, and is often part of a planned “Distributed Denial of Service” (DDoS) attack in which the compromised machine plays a part.

In addition to worms, users of desktop PCs are exposed to risks from viruses, often received by email or from unscrupulous websites. These viruses may install services on the PCs which can be controlled remotely.

Distributed Denial of Service Attacks

Distributed Denial of Service (DDoS) attacks use large numbers of client machines, often “recruited” after being compromised by worms or viruses. A malicious attacker can control these clients remotely, making the combined impact of a focused attack on an individual service provider or business far greater than a conventional DoS attack. Mitigating distributed attacks is far more challenging than handling a DoS attack, as it requires the cooperation (for example, outbound packet filtering) of other ISPs to fully address the issue.

The Traffic Manager can provide protection against basic DDoS attacks as well as DoS attacks, provided network bandwidth is not flooded and provided there is sufficient capacity to manage the incoming connections.

Malformed HTTP Attacks

Even correctly firewall-protected Web servers must still present their public services on port 80 to the Internet. HTTP’s client-server architecture means that clients can send data to these Web servers freely through port 80. This information can be crafted to maliciously overload or subvert a server. Attacks exist where the request is malformed in such a way as to exploit bugs and compromise the Web server to give control to a remote attacker.

Firewalls and Other Security Measures

Note that the Traffic Manager is not a firewall; it is intended to be used in conjunction with a dedicated firewall. See [System Security](#) for a full discussion of secure operation.

Protection Features

The Traffic Manager is a robust solution that is not affected by known classes of exploits. For example, they are believed to be invulnerable to all known worms and malformed HTTP attacks. In addition, since the Traffic Manager is placed at the point of ingress for traffic to your clusters - and is able to make intelligent routing decisions - it can help defend your platform from obvious network attacks and filter malicious content transparently. This is particularly effective if your back-end servers use a private network rather than having Internet IP addresses.

The Traffic Manager is also equipped with “Service Protection” features, which can be configured for each virtual server independently. These features allow requests to be managed and filtered dynamically in a number of ways.

Network Access Restrictions

The source IP address of a client can be used to decide whether or not to accept requests. If a particular IP address or network block is generating malicious requests, the Traffic Manager can be configured to drop all connections efficiently from these addresses, thus protecting the back-end pools from attack.

Connection Limiting

Often, clients abusing a system generate abnormally large numbers of connections. The Traffic Manager is able to detect and filter unusually heavy activity, based on the traffic from the top 10 busiest IP addresses or on the number of connections per minute being made from each IP address. This allows the Traffic Manager to deny access to clients making overly intensive requests to your systems.

Malformed HTTP Filtering

The Traffic Manager is able to detect and reject certain classes of malformed HTTP requests, and enforce standards-compliant requests from clients. For instance, the Traffic Manager can filter binary data from requests and prevent very large headers being used as a vector for a DoS attack.

Rule-Based Protection

The Traffic Manager service protection system can be configured to screen all incoming requests so that any matching the specified criteria are dropped. This functionality can be used to protect your system against known vulnerabilities in third-party applications running on your websites. For example, some business-critical applications such as shopping carts are sometimes found to have insecurities that are triggered by requesting a URL containing badly formed parameters.

The forms of these requests are often made public on security mailing lists. The Traffic Manager service protection system enables you to use this information to filter out any requests containing these badly formed parameters, so that you can resolve these vulnerabilities quickly and easily across all your websites.

You can configure the Traffic Manager to block requests by building up a list of rules that are used to filter all incoming requests. In addition you can limit the sizes of requests and the format of the information they can contain.

Enabling Service Protection

To apply protection to your services, first create a protection class in the "Service Protection" catalog. Then, assign the class to your virtual server through the **Services > Virtual Servers > Edit > Classes** page.

You can configure as many service protection classes as you require, each with its own settings and rules. Equally, you can apply a single service protection class to multiple virtual servers.

Adding a Service Protection Class

To add a service protection class, click **Catalogs > Service Protection**.

The Traffic Manager displays a list of existing service protection classes, and allows you to add a new service protection class by entering a name and clicking **Create Class**.

When you add a new service protection class, there are five main configuration groups.

Basic Settings

These settings enable and disable service protection and dictate in which mode the service protection class operates.

If you wish to bypass this service protection class temporarily, you can enable or disable service protection for the class. This is particularly useful if many virtual servers are configured to use the service protection class.

You can configure the log buffer time, which is the amount of time the Traffic Manager buffers logging in order to reduce disk writes (and reduce any knock-on problems if heavy logging results during a DoS attack). The Traffic Manager also includes a debug option, which causes verbose output to be logged.

ATTENTION

The debug option can create heavy loads on your Traffic Managers, and should not be used in production systems.

The Traffic Manager also offers a test mode, whereby the decisions made by the Traffic Manager with this service protection class are logged, but not acted upon. This option is designed to help tune the parameters of the service protection class to suit your services, and should be used for a period of testing before switching on protection.

Simultaneous Connections

These settings specify limits on the number of connections that the Traffic Manager allows from individual IP addresses:

| Setting | Description |
|------------------------------|---|
| max_1_connections | The maximum number of simultaneous connections the Traffic Manager allows from each connecting IP address. Set to 0 to disable this limit. |
| per_process_connection_count | <p>Determine whether the Traffic Manager uses a per-process simultaneous connection count model (each Traffic Manager typically has several processes, one process per available CPU core).</p> <p>Click "Yes" to allow the connecting IP address to make up to max_1_connections connections to each process within the Traffic Manager.</p> <p>Click "No" to allow the connection IP address to make up to max_1_connections connections to the Traffic Manager as a whole.</p> <p>If per_process_connection_count is set to "Yes", the following additional limits apply:</p> <p>max_10_connections: The maximum number of simultaneous connections from the top 10 busiest connecting IP addresses combined. The top 10 clients typically represent the majority of the load on a particular virtual server if any form of DoS attack is in progress or other abusive connections are being made to the Traffic Manager. It is therefore desirable to limit this particular group of users while leaving other requests untouched. For normal use, Ivanti suggests a value between 1 and 10 times the max_1_connections limit. To remove the effect of this limit, set it to at least 10 times the max_1_connections limit. The Traffic Manager ignores this setting if per_process_connection_count is set to "No", or max_1_connections is 0, or min_connections is 0.</p> |

| Setting | Description |
|---------|--|
| | min_connections: The entry threshold for the max_10_connections limit. The max_10_connections limit is not applied to connecting IP addresses with this many or fewer simultaneous connections. Set to 0 to disable both the max_1_connections and max_10_connections limits. The Traffic Manager ignores this setting if per_process_connection_count is set to "No". |

Connection Rate

ATTENTION

Connection rate limiting is per process, and each process independently imposes the rate on the connections it is handling.

These settings allow you to limit the rate at which each connecting IP address might make new connections or requests:

| Setting | Description |
|---------------------|--|
| max_connection_rate | The maximum number of connections that any individual IP address can make to the Traffic Manager during the interval specified in rate_timer . Set to 0 to disable the limit. In the case of HTTP, each individual request is counted as a connection, even if they are tunneled within a single Keepalive connection. |
| rate_timer | The interval (in seconds) the Traffic Manager uses to determine how frequently max_connection_rate is assessed. For example, a value of 60 imposes a limit of max_connection_rate connections per minute. All connection attempts above this limit are rejected for the remainder of the rate_timer interval. |

For more fine grained connection rate control, use the Request Rate Shaping feature described in [Request Rate Shaping](#).

Access Restrictions

The **Allowed** list allows you to specify allowed IP addresses or networks that are exempt from the normal service protection checks in this service protection class. In other words, IP addresses in this list are not subject to any of the limits set in the Simultaneous Connections and Connection Rate sections.

Use the **Banned** list to declare IP addresses or networks from which the Traffic Manager must always drop connections.

When checking a source IP, the subnets in both lists are evaluated using a longest-match first algorithm. In other words, the more specific subnet takes precedence. It is therefore possible to ban a more specific subnet contained within a less specific allowed one and vice versa. For example, allowing 192.168.0.0/16 and banning 192.168.128.0/24 allows requests from IP 192.168.0.137, but not from 192.168.128.137. If the same subnet is present in both the **Allowed** and the **Banned** list, requests from that subnet are allowed.

To add to either list, input the IP or network address in the appropriate box. Use one of the following formats:

- 192.0.2.0/255.255.255.0
- 192.0.2.0/24
- 192.0.2.1
- 192.0.2.

HTTP-Specific Settings

These settings provide extra checks which can be performed on HTTP traffic.

The Traffic Manager allows you to enforce compliance with RFC2396; this checks that the URL is properly formed according to accepted guidelines. Since standard Web browsers comply with RFC2396, this test will reject requests that include unusual or malicious data or formatting, while allowing legitimate requests to pass through.

The length of the HTTP body and any HTTP header can be restricted. This prevents a malicious attacker sending a very large or endless body or header. Web servers normally buffer incoming requests in progress in memory, and can therefore be vulnerable to a memory depletion attack. You can guard against this by preventing clients from sending large amounts of request data.

You can also specify a limit to the total size of all the HTTP headers. This prevents an attacker from constructing a very large request using a large number of HTTP headers.

You can limit the size of the URL requested, to prevent buffer overflow attacks and other attempts to use the URL as a vector for large amounts of data or worms.

After decoding, the Traffic Manager can reject HTTP headers that contain binary data. This is often an indicator of an attempted buffer-overflow attack, although some poorly written applications use binary data. If you suspect that your applications could be affected, you should first prove this feature using the test mode.

Finally, the Traffic Manager allows you to specify whether to reject requests silently if they fail one of the above tests, or to send HTTP error messages to the client that makes the request. Sending error messages incurs slightly higher overheads, which can be significant if a DoS attack is in progress.



If you associate this service protection class with a virtual server that does not handle HTTP traffic, then these settings will be ignored.

Service Protection Rule

This section displays the current rule, if any, which the service protection class is using. If you wish to change the rule, select the rule you wish to use from the drop-down menu. For more information on TrafficScript, please see [TrafficScript Rules](#).

To commit your settings and create the service protection class, click **Update**.

Applying a Service Protection Class to a Virtual Server

For a service protection class to take effect, it must first be assigned to a virtual server. To do this, click **Services > Virtual Servers** and choose an existing virtual server. Select **Classes** and locate the section entitled "Service Protection". The Admin UI offers a drop-down box of the service protection classes that are available in the catalog.

After you have selected a service protection class, click **Update**.

The Traffic Manager applies the new service protection class immediately across all Traffic Managers. A summary table indicating whether the service protection class is in test or debug mode is shown. If the service protection class has not been enabled (see [Basic Settings](#)) then this is indicated also.

Service Protection Performance

The Traffic Manager's service protection system requires additional memory and CPU time for each request. If you are managing a large number of requests and use sophisticated rules in your service protection class, every request for a virtual server using this service protection class will take slightly longer. For large systems it may be necessary to add further Traffic Managers to your front-end network in order to provide additional capacity.

Bandwidth Management

This chapter explains what Bandwidth Management is, and how to configure your Traffic Manager to control how bandwidth is used on your network.



Bandwidth Management is not available on all Traffic Manager variants. If required, it can be obtained via a software or license key upgrade.

What Is Bandwidth Management?

Bandwidth management allows the Traffic Manager to limit the number of bytes per second used by inbound or outbound traffic, for a virtual server or by the type of request.

Normally, network bandwidth is provided at the highest rate possible for all connections. This might result in uneven use of your network, possibly with too much bandwidth being used by secondary services at the expense of your most critical services. The Traffic Manager enables you to use bandwidth management to control this imbalance explicitly.

For example, consider you have a 20Mbits/s network connection that is being over-utilized for FTP downloads, and which is consequently affecting the responsiveness of the main HTTP service. You might therefore want to limit the bandwidth to the FTP virtual server to 2Mbits/s.

Bandwidth limits are automatically shared and enforced across all the Traffic Manager machines in a cluster. Individual Traffic Managers take different proportions of the total limit, depending on the load on each Traffic Manager. Unused bandwidth is equitably allocated across the cluster depending on the need of each Traffic Manager.



Bandwidth management is applicable only to traffic sent by the Traffic Manager. In other words, the Traffic Manager can control the bandwidth used when writing requests to server nodes, and when writing responses back to clients. The Traffic Manager CANNOT control how quickly clients write the requests to the Traffic Manager, or how quickly servers attempt to write responses to the Traffic Manager.

Bandwidth management applies to all data, whether sent to external addresses or just transferred internally within the Traffic Manager. Internal traffic includes, for example, where data is passed from a pool back to a virtual server using a loopback interface.

Configuring Bandwidth Management

The Traffic Manager's bandwidth management features are provided via the Catalog. This means that you may add more than one Bandwidth Management Class, each with its own limits. It also means that the choice of Bandwidth Management Class can be made through a TrafficScript rule, providing greater flexibility for situations where it is helpful to distinguish between requests to the same virtual server. For example, the Traffic Manager's Bandwidth Management system can be used to apply different limits for CGI requests than for image requests (see examples, below).

If you have a cluster of more than one Traffic Manager, the Bandwidth Management system takes this into account. You do not need to make adjustments when new servers are being added, as this is done automatically.

Adding a Bandwidth Class to the Catalog

To add a Bandwidth Management class to the Catalog, click **Catalogs > Bandwidth Classes**.

The Traffic Manager now shows a list of the existing Bandwidth Management classes, if any, and provides a box where you can create a new Bandwidth Management class.

Type a name into the box and click **Create Class**. The Traffic Manager now displays the settings page for this new class. You can select the maximum bandwidth and the limit sharing options.

To select the maximum bandwidth limit you can either:

- Select a predefined value from the drop-down list.
- Select Custom from the drop-down list and then enter your value, in kbits/second, in the box provided.

There are three possible modes for how the bandwidth class shares out bandwidth between connections:

- **Each connection is limited to the maximum rate:** No sharing is enforced, and all users of this class on all Traffic Managers will adhere to the maximum bandwidth limit set. This is useful when delivering video / audio streams to individual clients.
- **Bandwidth is shared per Traffic Manager:** The limit is shared amongst all users of the bandwidth class on each separate Traffic Manager. If you have a limit of 1 mbps and three Traffic Managers, each could deliver up to 1 mbps, giving a total of 3 mbps.

- **Bandwidth is shared across all Traffic Managers:** The limit is shared among all users of the bandwidth class across all Traffic Managers. With a limit of 1 mbps and three Traffic Managers, the cluster will only deliver 1 mbps total. Note that the limit is allocated dynamically - each Traffic Manager will be capable of using the full 1 mbps if the others are idle.

Click **Update** to commit your changes.



Unlike storage or memory capacity, network throughput is conventionally measured in factors of 1000 (not 1024).

Assigning a Bandwidth Class to a Virtual Server

A bandwidth management class that is assigned to a virtual server limits the bandwidth that the virtual server can use when sending response data to a client.

Configuration

To assign a Bandwidth Management class to a virtual server, click **Services > Virtual Servers**. Choose the virtual server from the list of available servers, and click the **Edit** button.

Next, click **Classes** and locate the section entitled "Bandwidth Management". Use the radio buttons to select one of the available Bandwidth Management classes.

Click **Update** at the bottom of the page to commit your change. The virtual server begins using this Bandwidth Management class immediately.



If you do not have any Bandwidth Management classes, the only option displayed is "none configured". To add a Bandwidth Management class, click **Create New Bandwidth Management Class**.

Assigning a Bandwidth Class to a Pool

A bandwidth management class that is assigned to a pool will limit the bandwidth that the pool can use when sending request data to a node.

Configuration

To assign a Bandwidth Management Class to a pool, click **Services > Pools**. Choose the pool from the list of available servers, and click the **Edit** button.

Next, click **Bandwidth Management**. Use the radio buttons to select one of the Bandwidth Management classes.

Click **Update** at the bottom of the page to commit your change. The pool begins using this Bandwidth Management class immediately.



If you do not have any Bandwidth Management classes, the only option displayed is "none configured". To add a Bandwidth Management class, click **Create New Bandwidth Management Class**.

Using TrafficScript to Select a Bandwidth Class

The bandwidth management class can also be selected per request, using either of the TrafficScript functions `request.setBandwidthClass()` and `response.setBandwidthClass()`. These functions affect the "to-node" and "to-client" bandwidth respectively.

A Bandwidth Management class can be applied at any point in a TrafficScript rule, and overrides the virtual server's own settings if they exist.

For example, the following TrafficScript response rule selects the "downloads" Bandwidth Management class for responses which are large, or are from the "/downloads/" part of the site:

```
# This must be used as a response rule, because we
# want to determine the response content length...
$url = http.getPath();
$cflen = http.getResponseHeader( "Content-Length" );

if( string.startsWith( $url, "/downloads" ) ||
    $cflen >= 100*1024 ) {
    response.setBandwidthClass( "downloads" );
}
```

Request Rate Shaping

This chapter explains what Request Rate Shaping is, and how to configure the Traffic Manager to rate-limit requests to your applications.



Request Rate Shaping is not available on all Traffic Manager variants. If required, it can be obtained via a software or license key upgrade.

What Is Request Rate Shaping?

Individual users may dominate the use of a service, to the detriment of other users of the service. A back-end application infrastructure may have limited scalability, being easily overwhelmed when too many requests are given to it. You may wish to restrict the rate at which certain activities can occur, such as sending an email, or logging in to a service, as part of a wider security policy.

Request Rate Shaping allows you to specify limits on a wide range of events, with very fine grained control over how events are identified. You can impose per-second and per-minute rates on these events.

For example:

- You can rate-shape individual web spiders, to stop them overwhelming your web site. Each web spider, from each remote IP address, can be given maximum request rates.
- You can throttle individual SMTP connections, or groups of connections from the same client, so that each connection is limited to a maximum number of sent emails per minute.
- You may also rate-shape new SMTP connections, so that a remote client can only establish new connections at a particular rate.
- You can apply a global rate shape to the number of connections per second that are forwarded to an application.
- You can identify individual user's attempts to log in to a service, and then impede any dictionary-based login attacks by restricting each user to a limited number of attempts per minute.

Request Rate Limits are imposed using the TrafficScript `rate.use()` function:

- A virtual server accepts incoming traffic.
- A request rule is run by the virtual server.

- The request rule applies the rate shaping, using the TrafficScript `rate.use()` function.



Request Rate Limits are most commonly used in TrafficScript request rules, to shape the rate at which requests are processed. They may be used in response rules if desired, and they can be used to restrict other events, but this is not a common requirement.

Configuring a Request Rate Shaping Class (Rate Class)

To use Request Rate Shaping, you need to add at least one Request Rate Shaping Class, or Rate class. Each Rate class defines a per-second and per-minute rate limit for events.

Rate classes are stored in the Catalog, and are invoked using the TrafficScript `rate.use()` function.

Adding a Rate Class to the Catalog

To add a new Rate class, click **Catalogs > Rate Shaping classes**. In the box labeled "Create new Rate class", enter a name for your new class, and then click **Create Class**.

Rate classes contain the following configuration settings:

| Setting | Description |
|----------------------------------|--|
| <code>max_rate_per_minute</code> | The maximum number of requests that can take place per minute. A value of "0" (zero) means no limit. |
| <code>max_rate_per_second</code> | The maximum number of requests that can take place per second. A value of "0" (zero) means no limit. |

You can configure both per-second and per-minute limits if you wish. Both limits are applied (note that if the per-minute limit is more than 60-times the per-second limit, it has no effect).

Once you have configured the Rate class, click **Update** to commit your changes.

Using a Rate Class

Rate classes function as queues. When the TrafficScript `rate.use()` function is called, the connection is suspended and added to the queue that the rate class manages. Connections are then released from the queue according to the per-second and per-minute limits.

Suppose you create a rate class named "shape requests" and configure it with a limit of 10 events (requests) per second.

The following TrafficScript request rule allows a maximum of 10 requests per second to be processed, no matter how rapidly new requests arrive at the system:

```
rate.use( "shape requests" );
```

As requests arrive, the request rule is executed. Provided that requests arrive at less than 10 per second, the `rate.use()` function just returns immediately and the request is processed without delay.

If more than 10 requests per second arrive, some will be queued by the `rate.use()` function. From a TrafficScript perspective, this function will block. When the request is dequeued, the `rate.use()` function then returns.

The Rate Queue

There is no limit to the size of the backlog of queued connections. For example, if 1000 requests arrived in quick succession, 990 of them would be immediately queued. Each second, 10 requests would be released from the front of the queue.

While they are queued, connections may time out or be closed by the remote client. If this happens, they are immediately discarded.

You can use the `rate.getBacklog()` function to discover how many requests are currently queued. If the backlog is too large, you may decide to return an error page to the user rather than risk their connection timing out:

```
if( rate.getBacklog( "shape requests" ) > 100 ) {  
    http.redirect( "http://some.other.site/" );  
} else {  
    rate.use( "shape requests" );  
}
```

This rule ensures that no more than 100 requests are ever queued by the rate class.

Avoiding Queuing

Alternatively, the TrafficScript function `rate.use.noqueue()` can be used to rate-shape requests in the same manner as `rate.use()`, with the key difference that requests are never queued:

- `rate.use.noQueue()` immediately returns the value 1 if the rate limit has not been exceeded. The connection rate is incremented. This is identical to `rate.use()`.
- `rate.use.noQueue()` returns the value 0 if the rate limit has been exceeded (whereas `rate.use()` would queue the request). You can then decide, using TrafficScript, what you would like to do with the request, such as returning a "503 Too Busy" error.

Selective Rate Shaping

You might want to just rate-limit particular types of request. For example, if you are using a mixture of Java extension pages and other content (such as images, static content etc.) on your Web site, you can rate-shape just the Java extension pages:

```
$url = http.getPath();
if( string.endsWith( $url, ".jsp" ) ) {
    rate.use( "shape requests" );
}
```

More Fine-Grained Rate Shaping

The examples above all apply a global limit. All requests are put into the same rate queue.

In many circumstances, you may need to apply more fine-grained rate-shape limits. For example, imagine a login page; we wish to limit how frequently each individual user can attempt to log in to just 2 attempts per minute.

With a global limit, the effect would be to restrict accesses to the login page to 2 per minute in total. We wish to impose independent per-user limits instead, so that each user is restricted to 2 logins per minute.

It would be possible to create a unique rate shaping class for each user, and select the appropriate class using TrafficScript, but there is a much better solution.

The `rate.use()` function can take an optional "key" which identifies a new instance of the rate class. This key can be used to create multiple, independent rate classes that share the same limits, but enforce them independently for each individual key:

```
$url = http.getPath();
if( string.endsWith( $url, "login.cgi" ) ) {
    $user = http.getFormParam( "username" );
    rate.use( "login limit", $user );
}
```

The rate shaping limits are applied independently to each different value of \$user. As each new user accesses the system, they are limited to 2 requests per minute, independently of all other users who share the "login limit" rate shaping class.

Rate-Shaping Web Spiders

Occasionally, a poorly written Web spider can overwhelm a Web site with requests, using excessive bandwidth and reducing the level of service that legitimate site users receive.

The following TrafficScript rule uses a rate class named "spiders" to limit individual spiders to 1 request per second. The TrafficScript identifies spiders as users who do not prefix their User-Agent header with either "Mozilla/" or "Opera/". It then applies limits to each individual spider instance, identified by the user agent and source IP address:

```
$ua = http.getHeader( "User-Agent" );

if( ! string.startsWith( $ua, "Mozilla/" ) &&
    ! string.startsWith( $ua, "Opera/" ) ) {
    $ip = request.getRemoteIP();
    rate.use( "spiders", $ua.$ip );
}
```

A more sophisticated rule might only restrict users to 1 request per second if they had previously exceeded a rate of, perhaps 10 per second over a period of 5 seconds, in order to dynamically detect spiders. It could work as follows:

- Maintain a list of known offenders (user agent and IP address) using the data.set() TrafficScript function. This list would initially be empty.
- When a request is received, check the list of known offenders, and use the 1-per-second rate if the request is to be throttled.
- Otherwise, use the 10-per-second rate, but before you apply the rate limit, check the backlog. If it is too large (greater than 50 perhaps), then the user has sent too many requests; insert them into the list of offenders.

Graphing Request Rate Shaping

Use the Activity Monitor to chart the activities of your request rate shaping classes, and monitor the values using SNMP.

Note that only global rate limits can be graphed or monitored in this way. You cannot graph or monitor rate limits that are applied to a specific key.

Service Level Monitoring

This chapter describes Service Level Monitoring, and how to configure the Traffic Manager to use Service Level Monitoring to monitor the response times on your network.



Service Level Monitoring is not available on all Traffic Manager variants. If required, it can be obtained via a software or license key upgrade.

Introducing Service Level Monitoring

Service response times are a key metric for Web services, as lower response times imply a more responsive and usable service. The response time used by Service Level Monitoring is the time in milliseconds taken from the Traffic Manager receiving a request to then sending the first byte of response data back to the client. It does not include the time taken to return the content to the client on the Internet, and generally is not affected by the speed of the remote network.

Response time includes the time taken for internal processing on the Traffic Manager (for example, running TrafficScript rules and Java Extensions), the time taken to send the request to the back-end node, the time taken for the node to generate and return the first data in the response, and the time taken to run any response rules. Response time is generally independent of the speed or latency of the client connection, so gives an accurate measure of the performance of the internal systems an application administrator can tune and optimize.



If additional data, such as HTTP POST body data, needs to be read from the client before the node returns a response, the time taken to read this data is included in the response time measurement.

Using Service Level Monitoring, the Traffic Manager can measure and react to changes in response times for your nodes, by comparing response times to a conformance value. You can obtain a graph of response times and other related information, or issue alerts or log when response times are below the conformance value. The Traffic Manager also has the ability to dynamically adjust the resources available based on response times, using TrafficScript rules.

Configuring a Service Level Monitoring Class (SLM Class)

To use Service Level Monitoring (SLM), add at least one SLM class to the Traffic Manager. Each SLM class contains the definition of its ideal response time and of thresholds for alerts and logging.

SLM classes are stored in the Service Level Monitoring catalog, and each class can be applied to one or more virtual servers.

Adding an SLM Class to the Catalog

To add a new SLM class, click **Catalogs > SLM**. In the box labeled "Create new service level monitoring class", type a name for your new class and click **Create Class**.

Each SLM class contains a number of configurable settings, as follows:

| Setting | Description |
|-------------------|---|
| response_time | The time limit, in milliseconds, against which the Traffic Manager measures response times. The Traffic Manager treats responses as conformant if the elapsed response time is shorter than or equal to this value. Responses that take longer than this value are non-conformant. For a description of how the Traffic Manager measures response time, see Introducing Service Level Monitoring . |
| serious_threshold | If the percentage of conformant responses drops below this level, a SERIOUS-level event will be raised, and a SERIOUS-level message written to the event log. |
| warning_threshold | If the percentage of conformant responses drops below this level, a WARNING-level event will be raised, and a WARNING-level message will be recorded in the event log. |

For example, you might set a response time of 1000ms, a warning threshold of 70% conformant responses, and a serious threshold of 40% conformant responses. This would mean that:

- If fewer than 70% of requests take less than 1000ms to return from a server, a warning entry is written to the Traffic Manager event log.
- If fewer than 40% of requests take less than 1000ms, a serious-level entry is written to the Traffic Manager event log.

The percentage of conformant requests is calculated from an average of the last 10 seconds' of requests, comparing the number of requests that fell within the **response_time** threshold to the total number of requests monitored by that SLM class.

You can define Event Handlers to call actions when “warning” or “serious” level events are raised by an SLM class.

After you have configured the SLM class, click **Update** to commit your changes.

Applying an SLM Class to a Virtual Server

To apply an SLM class to a virtual server, click **Services > Virtual Servers**. Choose the virtual server from the list of available servers, and click the **Edit** button.

Next, click **Classes** and locate the section entitled “Service Level Monitoring”. Use the radio buttons to select one of the available SLM classes.

Click **Update** to apply your change.

After your SLM class has been associated with a virtual server, it is used immediately for all requests. You can, however, change the SLM class depending on the nature of the request by using TrafficScript, as shown in the sections that follow.

Applying SLM Classes from TrafficScript

TrafficScript includes a number of functions that can be used to read current information from an SLM class, or change the SLM class for a connection.

These functions are documented in the **TrafficScript Reference** (available through the Online Help).

Note in particular `connection.setServiceLevelClass()` which selects a particular SLM class for the request, overriding the virtual server's default SLM class. See also `slm.conforming()`, which returns the current conformance percentage value.

SLM Class TrafficScript Examples

The following examples illustrate how a default SLM class can be overridden for certain types of requests, and how to use the performance of one SLM class to control how you manage traffic.

"FrontPage™ Scripts Only" Service Level Monitoring

Microsoft FrontPage™ upload scripts can take a long time to run, particularly when the client is uploading content from a slow connection. This can even lead to a pool being marked as failed, even though there is no malfunction.

To distinguish between response times for normal content, and response times for FrontPage binaries, we can use a TrafficScript rule that detects FrontPage requests (located in `_vti_bin`).

```
$path = http.getPath();

if( string.StartsWith( $path, "/vti_bin" ) ) {
    connection.setServiceLevelClass( "FrontPage" );
} else {
    connection.setServiceLevelClass( "Regular" );
}
```

The FrontPage SLM class should allow considerably higher response times than the Regular class used for all other requests managed by the virtual server.

Prioritizing Resources with Service Level Monitoring

This example tags premium customers with a “premium” service level monitoring class, and directs them to the “premium” pool.

Non-premium customers can share the premium pool if the premium SLM class is functioning within its tolerance, but are directed to the “standard” pool if the premium SLM class is running too slowly.

```
if( $IsPremium ) {
    connection.setServiceLevelClass( "premium" );
    pool.use( "premium" );
} else {
    if( slm.conforming( "premium" ) == 100 ) {
        pool.use( "premium" );
    } else {
        pool.use( "standard" );
    }
}
```



`pool.use()` ends the TrafficScript rule immediately and sends the request to the specified pool.

Graphing SLM Class Conformance Rates

To obtain a graph of data for a specific SLM class, click **Activity**. Underneath the current activity graph, click **Change Data**.

The Traffic Manager now displays a tree of different values which can be plotted. Expand the node marked **Service Level Monitoring Classes**.



You can now select whether to plot data for one particular SLM class, or for all SLM classes. You can also plot values for the measurement data used by the SLM class, for example average response times for the SLM class. A useful graph might include total connections and total non-conforming connections for all SLM classes on the same plot, facilitating a visual comparison of the overall performance of a system.

All of the connection data and response time data can be plotted on a per node basis. This can be used to identify nodes which are under performing. A good graph to achieve this would be to plot the mean response times of each of the nodes used by the SLM class. To select data for a node used by an SLM class, unfold the section with the name of the SLM class and check the nodes you are interested in.

Content Caching

This chapter describes the Traffic Manager's Content Caching capabilities, and explains how it can be configured to reduce the load on the back-end Web-serving nodes.



Content Caching is not available on all Traffic Manager variants. To obtain this feature, contact your support provider for a software or license key upgrade.

ATTENTION

See also [Content Caching](#) that discusses the effect on caching when Pulse Secure Web Accelerator (Web Content Accelerator) functionality is enabled within your virtual servers.

Introduction

Most Web servers host a wide range of different types of content, which together make up the Web sites and services that are offered. For example, a typical Web site will include standard Web pages (HTML files), images (GIF, JPEG or PNG files), CSS style sheets and JavaScript source files. Depending on the service offered by the Web site, the Web site is also likely to contain some personalized, custom content that is generated by applications hosted on the Web server.

The Traffic Manager's Content Caching capability allows the Traffic Manager to identify the content that is not customized for each request and to remember ("cache") the content. The content might be "static", such as a file on disk on the Web server, or it may have been generated by an application running on the Web server.

When another client asks for content that the Traffic Manager has cached in its internal Web cache, the Traffic Manager can return the content directly to the client without having to forward the request to a back-end Web server.

This has the effect of reducing the load on the back-end Web servers, particularly if the Traffic Manager has detected that it can cache content generated by complex applications that consume resources on the Web server machine.

Configuring Content Caching

Content Caching is performed by an HTTP virtual server. The virtual server stores common responses in a Web cache, and replies to common requests by serving the response directly from the Web cache.

Applying Content Caching to a Virtual Server

To configure Content Caching for an HTTP virtual server, click **Services > Virtual Servers**. Choose the virtual server from the list of available servers, and click the **Edit** button.

Locate "Content Caching" and click **Edit**. Enable or disable Content Caching for that virtual server using **webcache!enabled**.

To apply your changes, click **Update**.

ATTENTION

If Web Content Accelerator functionality is enabled for this virtual server, the Traffic Manager always stores optimized resources, such as combined images, in the cache regardless of the **webcache!enabled** setting. However, the Traffic Manager does not attempt to cache optimized HTML pages generated by the Web Content Accelerator unless this setting is enabled. If both the cache and Web Content Accelerator are enabled, the Traffic Manager also caches un-optimized resources that the Web Content Accelerator fetches.

Configuring Lifetimes

The Traffic Manager automatically caches the most frequently requested content, making optimum use of the Web cache.

For each virtual server that uses the Web cache, you can configure how long resources are cached before they become "stale" and are discarded. Use the following settings for this purpose:

| Setting | Description |
|-------------------------|--|
| webcache!time | How long (in seconds) is a resource cached for? |
| webcache!errorpage_time | How long (in seconds) is an error page cached for? |
| webcache!refresh_time | How soon before a resource expires should the Traffic Manager begin refreshing it? |

The Traffic Manager caches regular HTTP responses for the period of time set in **webcache!time**. The resource is loaded into the cache the first time that a remote client requests it; then subsequent requests for the same resource are served directly from the cache until the time expires.



If the resource is changed on the back-end server, it can take up to **webcache!time** seconds before the Traffic Manager notices and the cached copy is updated. For a description of how out-of-date content can be forced out of the cache, see [Forcing Stale Content out of the Cache](#).

The Traffic Manager also caches error pages (404 Not Found, 410 Gone, 501 Not Implemented, and so on), but uses the **webcache!errorpage_time** setting to determine how long they are cached for before they are requested again from a back-end server. Typically, you do not want to cache error messages for very long; you should recheck the content more frequently so that the error message could be purged and replaced with the correct content.



The Traffic Manager never caches pages returned as a result of a server error, such as “503 Too Busy”.

Expiring Resources

The Traffic Manager does not automatically delete cached content upon expiry. If the cache becomes full and space is required for new content, the Traffic Manager frees up space by removing the least recently-used content. This is regardless of whether the cache contains more recently-used, but expired, content that could be deleted.

When a resource expires, requests for that resource are sent to the back-end servers until the complete resource is loaded into the cache again. If there are many concurrent requests for the same resource, or if the resource takes a long time to generate, this can cause a large spike of traffic to the back-end servers.

The **webcache!refresh_time** setting addresses this problem. This value controls how the Traffic Manager speculatively updates the cache when a resource is due to expire.

For example, suppose **webcache!refresh_time** is set to 10 seconds. In the final 10 seconds before a resource is due to expire, if the Traffic Manager receives a request for the resource, it forwards the request to the back-end server rather than using the cached response. If the back-end servers provide a valid response, this response is used to update the cache and the expiry counter is reset.

The Traffic Manager only sends a maximum of one request per second for each resource to the back-end servers during the **webcache!refresh_time** period. Other requests for the resource are met using the cached response. In this manner, the cache can be refreshed before it expires, avoiding a large flood of requests to the back-end servers.

Configuring Web Cache Memory Usage

Ivanti recommends you configure the memory usage of the Web cache carefully, to ensure that:

- The cache is sufficiently large to contain all variants of the most frequently requested pages.
- The cache is not too large that it causes the host machine to swap part of the running the Traffic Manager processes to disk.
- All virtual servers share the same global cache memory, and the sizes are configured globally for your Traffic Manager.

To configure the Web cache memory sizes, click **System > Global Settings > Cache Settings**. The following settings apply:

| Setting | Description |
|--------------------------|--|
| webcache!size | Upper limit for the amount of memory (in Mb) that the Web cache can consume. It can also be specified as a percentage of total system memory. |
| webcache!max_file_num | Limits the maximum number of entries that can be placed into the cache. |
| webcache!max_file_size | Determines the size of the largest file that will be inserted into the cache. This can be specified as a percentage of the total cache size, or as an absolute file size. |
| webcache!avg_path_length | This is the estimated average length of the path (including the query string) for resources being cached. An amount of memory equal to this figure multiplied by webcache!max_file_num will be allocated for storing the paths for cache entries. |
| webcache!max_path_length | This is an upper bound on how long a path can be when stored in the cache. Its purpose is to stop one very long URL using up excessive storage space. |
| webcache!verbose | Enable this setting to add a header named "X-Cache-Info" to HTTP responses to show whether the request/response is cacheable. |
| webcache!normalize_query | Enables normalization of the query string. |
| webcache!disk | Enables usage of a disk-backed cache. Refer to Configuring Disk-Based Caching . |

| Setting | Description |
|-------------------|---|
| webcache!disk_dir | If disk caching is enabled, this sets the directory where the disk cache file will be stored. |

Monitoring Cache Activity

To monitor the activity of the Web cache, click **Activity > Content Cache**. This page displays the contents of your Web cache, and how many variants of each response are stored. The Content Cache page also indicates how much memory is used by your Web cache.

You can also reach this page by clicking **View cache contents** on the **Virtual Server > Edit > Content Cache** page.

The Content Cache activity page includes the percentage of allocated entries and memory that is currently in use, and a selector so that you can explore the content in the cache and manually expire cache items if desired.

If your cache is full, or almost full, either the **Entries** value will be close to the **MaxEntries** value, or the **MemUsed** value will be close to the **MemMaximum** value. In this case, when new entries are inserted into the cache, the least-used entries will be discarded before they expire. You can monitor the value of **Oldest** to determine the time since the least-used entry in the cache was last used.

To graph cache usage in real-time, click **Activity > Current Activity** to access the Traffic Manager's activity monitoring page. In the "Settings" section, set **Chart Data** to "HTTP Content Cache". This cache activity information is also available through SNMP.

Configuring Disk-Based Caching

Typically, the Traffic Manager's cache resides in main memory and the size you select is determined by the quantity of RAM available after accounting for the operating system, application memory, network buffers, and so on.

As an alternative, the Traffic Manager may be configured to use a larger cache that is stored on a local disk. This results in an effective two-tier cache because the operating system will store the most active parts of the disk-based cache in memory, using the system's kernel disk buffers.

Configuring the Cache

To use a disk-based cache, perform the following steps:

1. Click **System > Global Settings > Cache Settings**.
2. Configure the size of your cache, in MB or GB. This size might be several times larger than the amount of memory in the server.
3. Enable disk-backed caching with the **webcache!disk** setting.
4. Select a location for the disk cache. This location must be a local directory with sufficient free space, and you are strongly recommended to select a location on fast SSD (Solid State Drive) storage, rather than on a slower local HDD (Hard Disk Drive).
5. Click **Update** to save your settings.
6. To fully apply disk-based caching, restart your Traffic Manager from the **System > Traffic Managers** page.

The disk cache is not persistent, and is cleared and reset when the Traffic Manager software is restarted. You cannot share disk caches between multiple Traffic Manager systems.

SSD and HDD Disk Caches

The disk cache is stored in a single flat file created in the selected location. All reads and writes to the cache can potentially result in a disk access, although the host operating system will cache the most commonly accessed parts of the file and perform writes in the background.

You are very strongly recommended to use a local SSD drive for the cache files because reads, writes and seeks on these drives are very fast. Reads, writes and seeks on a HDD are much slower – a typical mechanical HDD is limited to several hundred disk operations per second, which then limits the number of requests per second the Traffic Manager can process via the cache.

Caching Policy

Not all Web content can be cached. Information in the HTTP request and the HTTP response drives the Traffic Manager's decisions as to whether or not a request should be served from the Web cache, and whether or not a response should be cached.

Requests

Only HTTP GET and HEAD requests are cacheable. All other methods are not cacheable.

The "Cache-Control" header in an HTTP request can force the Traffic Manager to ignore the web cache and to contact a back-end node instead.

Requests that use HTTP basic-auth are uncacheable.

Responses

The "Cache-Control" header in an HTTP response can indicate that an HTTP response should never be placed in the Web cache.

The header can also use the "max-age" value to specify how long the cached object can be cached for. This can cause a response to be cached for less than the configured **webcache!time** setting.

HTTP responses can use the "Expires" header to control how long to cache the response for. Note that using the "Expires" header is less efficient than using the "max-age" value in the Cache-Control response header.

The "Vary" HTTP response header controls how variants of a resource are cached, and which variant is served from the cache in response to a new request.

If a Web application wishes to prevent the Traffic Manager from caching a response, it should add a "Cache-Control: no-cache" header to the response.

To debug your cache behavior, set **webcache!verbose** to "Yes" in **System > Global Settings > Cache Settings**. If you enable this setting, the Traffic Manager adds a header named "X-Cache-Info" to the HTTP response to indicate how the cache policy has taken effect.

For further details about HTTP cache policies, see RFC 2616.

Variants

A URL can have multiple variants if:

- The response depends on additional request parameters, such as the Accept-Encoding or Accept-Language headers. The origin web server will indicate that this is the case by including a 'Vary' header in the response:

```
Vary: Accept-Language, Accept-Encoding
```

- The TrafficScript function `http.cache.setkey()` has been used to indicate the response content depends on other computed parameters.

Byte Ranges

Byte-ranges are used by some client software to request a portion of a document. For example, a PDF reader may download the first part of a PDF file (which contains an index of pages), and then issue a byte-range request to retrieve the pages the user wants to read.

The Traffic Manager treats byte-ranges as a variant of a URL (for more information, see [Variants](#)). Byte range responses are cached, and if another request for the same byte-range is received, the response is served directly from the cache.

If the Traffic Manager caches the entire response for a URL, the Traffic Manager serves all byte-range requests from that response.

ETags

ETags (entity tags) are used by Web servers to uniquely identify each version of a response. The Traffic Manager caches and honors ETags and will respond with a “304 Not Modified” response if the current cached version of a resource has the same ETag as the version cached by the remote client.

Controlling Content Caching Using TrafficScript

HTTP Request Processing

When the Traffic Manager receives a new HTTP request, it must determine whether it can serve a response directly from the Web cache, or whether it should forward the request on to a back-end server. The Traffic Manager executes all TrafficScript request rules on the request before it inspects the Web cache. Consequently, a TrafficScript request rule can modify a request and influence the Traffic Manager’s decision.

For example, a TrafficScript request rule could add a “Cache-Control: no-cache” header to a request to prevent the Traffic Manager from serving the response from the local Web cache.

HTTP Response Processing

Similarly, when the Traffic Manager receives an HTTP response from a back-end server node, it must decide whether or not to insert the response into the Web cache for future use. The Traffic Manager executes all TrafficScript response rules before making this decision, so a TrafficScript response rule can modify a response and influence this decision.

A TrafficScript response rule could add a "Cache-Control: no-cache" header to the response to prevent it from being cached, or a "Cache-Control: max-age=60" header to indicate that the response should be cached for 60 seconds.

Note that if a response is served from the Web cache, the TrafficScript response rules are not executed.

TrafficScript Cache Control Functions

Several cache control functions are available to facilitate the control of the Traffic Manager's caching behavior. In most cases, these functions eliminate the need to manipulate headers in the HTTP requests and responses.

| Function | Description |
|-----------------------------------|--|
| <code>http.cache.disable()</code> | Invoking <code>http.cache.disable()</code> in a response rule prevents the Traffic Manager from caching the response. |
| <code>http.cache.enable()</code> | Invoking <code>http.cache.enable()</code> in a response rule reverts the effect of a previous call to <code>http.cache.disable()</code> . It causes the Traffic Manager's default caching logic to take effect. Note that it is not possible to force the Traffic Manager to cache a response that it deems to be uncacheable. |
| <code>http.cache.setkey()</code> | The <code>http.cache.setkey()</code> function is used to differentiate between different versions of the same request, in much the same way that the Vary response header functions. It is used in request rules, but may also be used in response rules. It is more flexible than the RFC2616 Vary support, because it lets you partition requests on any calculated value – for example, different content based on whether the source address is internal or external, or whether the client's "User-Agent" header indicates an IE or Gecko-based browser. |

| Function | Description |
|---|--|
| <code>http.cache.exists()</code> | The <code>http.cache.exists()</code> function can be used in a request rule to check if a matching response exists at that instant in the cache. If the rule were to terminate without modifying any of the request parameters, the response would be served from the cache (unless it had expired in the intervening time). |
| <code>http.cache.respondIfCached()</code> | <p>This function can be called in a request rule. If a matching response exists in the Web cache, the rule terminates immediately and the response is sent back to the remote client. No further request (or response) rules are run.</p> <p>If a matching response does not exist, the function returns and rule processing continues.</p> <p>This can be used to support logic such as rate shaping, whereby you wish to rate-shape requests to back-end nodes, but do not need to apply a rate limit if you can serve the response directly from the Traffic Manager cache:</p> <pre>http.cache.respondIfCached(); rate.use("my rate limit");</pre> |

For more information and code samples, see the *Pulse Secure Virtual Traffic Manager: TrafficScript Guide* available from the Ivanti Web site (www.ivanti.com).

Forcing Stale Content out of the Cache

If you update part of the content for your load-balanced Web site, the Traffic Manager only picks up the new content when the existing cached versions expire.

You can manually force the Traffic Manager to expire content from the cache, so that it retrieves the updated versions next time a client requests the content, or you can do so programmatically.

Manual Removal of Cached Content

To manually remove cached content, perform the following steps:

1. Click **Activity > Content Cache** to view a selection of the files that are currently cached by your Traffic Manager cluster.
2. If necessary, use the **Display Cache Items** selector to locate the items you want to expire, specifying host header matches and path matches to narrow the selection down.
3. Select the entries you want to expire and click **Clear Selected**.

This immediately invalidates cached copies of these resources, and forces the Traffic Manager to retrieve new versions the next time a client requests them.

Programmatic Removal of Cached Content

The Traffic Manager Control API includes SOAP methods to inspect and invalidate entries in the cache; these methods are located in the System.Cache interface.

A content provisioning system that uploads new content to Web servers could also potentially invoke a script that used the Traffic Manager Control API to invalidate any updated items from the content cache.

For more information, see the *Pulse Secure Virtual Traffic Manager: Control API Guide*.

Using Pulse Secure Web Accelerator

This chapter discusses how to optimize your Web content by using Pulse Secure Web Accelerator.

Introduction

Faster-loading Web pages provide users with a more satisfying experience because they reduce waiting time for a Web page to render and be usable. Studies show that with an average Web page load time of six seconds, only about one second is spent inside the application and Web server, with the user waiting another four to five seconds for the client browser to render the Web page. Reducing Web page load time is vital to improving the overall user experience.

Pulse Secure Web Accelerator (Web Content Accelerator) automatically optimizes Web page markup and elements so they load faster for end users. The technology is present within your Traffic Manager infrastructure and no changes are required to your back-end applications.

Modes of Operation

Web Content Accelerator is an optional Traffic Manager feature that is enabled through a specially configured license key. Two levels of functionality are available, depending on your license key: Express and Enterprise.

Web Content Accelerator Express applies a predefined level of optimization to your Web content, designed to best match a wide range of applications. In this mode, a virtual server with Web Content Accelerator enabled compresses the HTML contained in Web pages it processes. It also performs the following optimizations on the page resources as the client fetches them:

- Minification and compression of JavaScript files.
- Minification and compression of style sheets.
- Background images are inlined or versioned.
- Web fonts are versioned.
- Resampling of image content.
- Compression of all resources.

For more information on each of these items, see [Understanding Optimization Techniques](#).

ATTENTION

In Express mode, Web Content Accelerator cannot be used to optimize sites requiring authentication. For more details, see [Authentication](#).



Web Content Accelerator-specific TrafficScript functions are limited to operating with their default parameters in Express mode, and cannot be overridden. See the *Pulse Secure Virtual Traffic Manager: TrafficScript Guide* for more information.

An Enterprise license permits Web Content Accelerator to inspect and modify the content of HTML pages, enabling it to perform a full range of optimization techniques. Web Content Accelerator Enterprise also provides full control over the individual optimization parameters that are applied to your Web infrastructure. You can create and apply specific optimization profiles to individual application scopes handled by your virtual servers.

This chapter provides a complete description of the features and capabilities of Web Content Accelerator when running in Enterprise mode. Some elements do not apply to Express mode.

Configuring Web Content Accelerator for Your Services

Web Content Accelerator can be enabled as a property of a virtual server, through the Web Content Accelerator link on the **Virtual Servers > Edit** page of the Admin UI.

It is possible to fully enable or disable Web Content Accelerator functionality for a virtual server using the **optimizer!enabled** configuration key in the “Basic Settings” section.



If you are running Web Content Accelerator Express, the UI controls discussed in the remainder of this section are not applicable and should be considered for reference only. Contact your support provider for more information.

A virtual server manages traffic for a specified port and protocol. Requests that it handles might be for a particular application, based upon the URL requested; for example, “http://www.mywebsite.com/supportsystem”. This hostname and path combination can be used to create a connection between the application being requested (through this virtual server) and the optimization profile that should be used when it is identified.

In the Web Content Accelerator “Profiles” section, you can define the mappings between various acceleration Profiles you want to use and the “Scope” within which they should apply. Profiles and Scopes are **Catalog** objects and must be created before being used on this page. To learn more about each of these concepts, see the sections that follow.

You can define and map several Scopes to a single Profile, depending on your requirements, though a scope can only be used once within a single virtual server.

The Web Content Accelerator Wizard

As with other wizards, the Traffic Manager provides an automated process to enable you to quickly set up Web content optimization on your Web services: the **Optimize a web application** wizard.

You must have previously created at least one virtual server in order to do this; the wizard cannot run without one. It is recommended that you first follow the **Manage a new service** wizard in order to create a suitable virtual server upon which to run the wizard.

To run the wizard, select **Optimize a web application** from the "Wizards" drop-down menu in the navigation bar.

The wizard has three main steps:

1. Select the virtual server upon which you are applying optimization.
2. Select the Application scope.
3. Select the Web Content Accelerator profile to be applied for that scope.

Application Scopes

An Application Scope object is used to define a collection of URLs that match a specific Web site or application hosted by a virtual server. To view, modify, and add new Application Scopes, click **Catalogs > Web Content Accelerator Catalogs > Application Scopes catalog**.

When a request is received through a virtual server, a match is sought to the most-specific URL within the Scope mappings defined in **Virtual Server > Edit > Web Content Accelerator**. If the Traffic Manager finds a match, it applies the appropriate optimization Profile defined in the mapping.

Several hostnames can be included in one Scope record. However, all these names should be aliases for the same host, and it should be possible to fetch the same resources using any of them. If an alternate hostname is used to serve content from a Content Delivery Network, then that CDN must proxy the origin host so that content passes through the same Application Scope again within the Traffic Manager.

To match “any” hostname, create a new scope record and leave the **hostnames** list blank. Alternatively, where multiple applications are hosted through a particular virtual server, differentiated by the URL in the request, set up a new Scope record for each combination of hostname and root path involved.

Resources served through the virtual server will only be considered for optimization if they match both the hostname declared in the attached scope and the port on which the virtual server is running. The hostname match will be performed using the hostname(s) specified in the scope, or using the hostname of the page request if the scope hostname setting is blank. All requests for dependent resources will use the primary hostname (first in the list) if explicitly set.

To optimize resources hosted on a different host, such as an external media host, use a Web Content Accelerator Profile that includes a URL rule with the **Applies to externally hosted resources** option enabled. For more details, see [Acceleration Settings](#).

Applying an Application Scope that specifies a hostname to a virtual server that does not host an application by that name may cause requests to fail with a 502 status - if you see this HTTP status, check that the Application Scope hostnames are logically grouped by the application they represent.



Ensure that multiple scopes do not provide conflicting URL matches.

When creating a new scope entry, the **root** configuration key can be utilized to further identify the root path to the application in scope.

A built-in scope is automatically provided, entitled “Any hostname or path”, that can be used where no specific hostname and/or path identification is required within the Web application. The **hostname** field is blank, and the **root** field is set to “/” accordingly.

Web Content Accelerator Profiles

The Web Content Accelerator Profiles catalog contains a list of profiles that can be applied to websites and Web applications to enable automatic content optimization. To view, modify, and add new Web Content Accelerator Profiles, click **Catalogs** > Web Content Accelerator **Catalogs** > Web Content Accelerator **Profiles catalog**.

Built-in and Custom Profiles

The Traffic Manager provides a number of “built-in” profiles that provide pre-defined optimization settings for your Web applications. These profiles are not modifiable or deletable, and are designed to offer a choice of optimization settings applicable to most situations. Choose from:

| Name | Description |
|-----------------|--|
| Express | This profile provides basic optimization settings and techniques designed for a wide range of web sites. These techniques include shrinking CSS, inlining CSS background images, minifying javascript, shrinking images, and advanced caching. |
| SharePoint 2007 | This profile provides optimization settings tuned for acceleration and compatibility with Microsoft SharePoint 2007 Internet and intranet sites. It includes resource URL versioning, durable caching, CSS StyleSheet inlining, CSS minification, background image inlining, JavaScript minification, compression, image shrinking and metadata removal, and advanced JavaScript compatibility. |
| SharePoint 2010 | This profile provides optimization settings tuned for acceleration and compatibility with Microsoft SharePoint 2010 Internet and intranet sites. It includes resource URL versioning, durable caching, CSS StyleSheet inlining, CSS minification, background image inlining, JavaScript minification, compression, image shrinking and metadata removal, advanced JavaScript compatibility and SharePoint ribbon optimization. |
| SharePoint 2013 | <p>This profile provides optimization settings tuned for acceleration and compatibility with Microsoft SharePoint 2013 Internet and intranet sites. It includes support for a SharePoint feature called Minimal Download Strategy (MDS). This is designed to reduce the white-screen effect when navigating between pages and to reduce the data transferred.</p> <p>As your browser navigates from page to page, the HTTP page responses contain only fragments of HTML that differ from the previous page. Without MDS enabled, each page response contains the entire page content. The MDS feature is enabled by default, but it is disabled after the site "look and feel" is customized.</p> <p>Differences to the SharePoint 2010 profile are:</p> <p>Web Content Accelerator supports and optimizes MDS fragments.</p> |

| Name | Description |
|--------------------------------|---|
| | <p>SharePoint 2013 loads many individual scripts. Web Content Accelerator optimizes this behavior by delivering script content through preconfigured script sets. For example, when SharePoint requests “/_layouts/15/init.js”, Web Content Accelerator delivers a script set containing that and other scripts normally loaded at the same time. When SharePoint needs one of these scripts, it is already in the browser cache as part of the Web Content Accelerator script set and can be used immediately.</p> |
| SharePoint 2013 Custom Website | <p>The SharePoint 2013 user interface can be heavily customized, and might not use all the default scripts, styles, and images that a default SharePoint 2013 site uses.</p> <p>This profile is an adapted version of the standard "SharePoint 2013" profile, designed for customized Web sites that do not require the default SharePoint scripts and resource sets to be downloaded by browsers.</p> <p>For default SharePoint sites, use instead the "SharePoint 2013" profile.</p> |
| Other Web application | <p>This profile provides basic optimization settings appropriate for safely accelerating most Web applications. It includes CSS StyleSheet inlining, CSS minification, background image inlining, JavaScript minification, compression, and image shrinking and metadata removal. You can use this profile as a template for creating new profiles customized to the optimization requirements of your Web applications.</p> |
| Basic (deprecated) | <p>This profile is designed to enable a useful number of basic optimization techniques that work well on a wide range of Web sites. These techniques include shrinking CSS, in-lining CSS background images, “minifying” JavaScript, shrinking images, URL versioning and advanced caching.</p> |

| Name | Description |
|--------------------------|---|
| Advanced (deprecated) | This profile enables more advanced optimization techniques in addition to those offered by the Basic profile, including combination of CSS style sheets and combination of HTML images into image sprites. These techniques will dramatically reduce page load time, but may require customized rules for compatibility with some sites. In this case, you would clone the profile in order to create a custom Web Content Accelerator profile (discussed later). |

If these profiles cannot offer you the desired level of optimization across all elements of your Web site, you can opt to create a new custom Web Content Accelerator Profile that fulfills your specific requirements.

To create a custom profile, use the "Create a new Web Content Accelerator Profile" section, specifying one of the built-in profiles as a template. Select the desired template profile from the drop-down list and then click **Create Web Content Accelerator Profile**. Built-in profiles can also be duplicated to create new custom profiles using the **Save As** option on the **Edit Profile** page.

Custom profiles provide a range of additional acceleration options. For further information, see [Understanding Custom Acceleration Profiles](#).

Optimization Modes and Page Information

Web Content Accelerator can run in one of three modes, defined using the **optimizer_mode** configuration key:

- **Off:** Acceleration is disabled, but requests for Web Content Accelerator resources are served.
- **Stealth:** Acceleration is disabled, except where enabled using the query string command:

```
?optimizer=on
```

- **On:** Acceleration is enabled for all requests.

You can elect to show request information for each Web page that is passed through a Web Content Accelerator Profile using the **show_info_bar** configuration setting on the **Edit Profile** page. If this is set to "Yes" and acceleration is currently active, all pages in this session will show a status bar which includes controls to provide information specific for that request.

Background Optimization

Optimizing complex resources, such as large image sets or CSS files with multiple nested imports, can be a time-consuming process. Although Web Content Accelerator will do this only once for a given resource, it might result in the client that first requires this optimized resource having to wait for it to be completed.

This section allows you to configure Web Content Accelerator to complete optimizations in the background, serving the original un-optimized server content to all clients that request it until the optimized data is ready.

 Resources, such as combined image sets, will be automatically cached after they are optimized. Web pages will be cached only if the virtual server's **webcache!enabled** setting is "Yes". However, if all the resources on the page have already been optimized, the fully optimized page can be delivered quickly.

The Traffic Manager offers two profile settings for determining whether and how to optimize resources in the background:

| Setting | Description |
|-----------------------------------|---|
| background_after | <p>Specifies the number of milliseconds after which the optimization will be put into the background and the original server content will be served to the client.</p> <p>When set to 0, Web Content Accelerator will always wait for the optimization to complete before sending a response to the client.</p> <p>Some resources, such as JavaScript files, must always be served optimized. As such, they cannot be optimized in the background using this setting.</p> |
| background_on_additional_resource | <p>When a page, or a resource such as a CSS document with nested imports, requires Web Content Accelerator to fetch additional resources to complete the optimization process, do the optimization in the background.</p> |

Measuring Web Content Accelerator Changes

This section explains how to test Web Content Accelerator and measure Web page performance using a variety of tools. These measurements can be used to determine how effectively Web Content Accelerator is accelerating your Web service.

Checking That Web Content Accelerator Is Active

To check that your Web content is being accelerated, use your browser's "View HTML Source" option after loading a Web page. Search for the following comment:

```
<!-- Optimized for speed - Pulse Secure Web Accelerator -->
```

If you do not see this comment, see [Configuring Web Content Accelerator for Your Services](#).

Using Stealth Mode to Test Web Content Accelerator

If you do not have a development or test environment available you can still test Web Content Accelerator by running the accelerator in Stealth Mode.



Stealth Mode is not available with Web Content Accelerator Express.

In Stealth Mode, Web Content Accelerator will not apply any optimization to Web pages, unless commands are passed within the query string. End users will not see any change in the way Web pages behave or appear.

When running Web Content Accelerator in Stealth Mode all incoming requests for pages and objects will be served in their original form. If the request contains the parameter `optimizer=on` in its query string, Web Content Accelerator will send a cookie that represents an explicit instruction to accelerate all requests for this browser session.

When Web Content Accelerator sees the enabling cookie on the incoming requests it will intercept and accelerate them according to the rules and settings defined in the Web Content Accelerator profile applicable to that scope.

These are examples of valid requests:

```
www.example.com?optimizer=on  
www.example.com/destinations?optimizer=on
```

You configure Web Content Accelerator to run in Stealth Mode by changing the **optimizer_mode** configuration key in the relevant profile.

Measuring Web Page Speed

To find exactly what has changed since enabling Web Content Accelerator you will need before and after Web page load time measurements.

An initial measurement should be used as a baseline to which further measurements will be compared. Ideally the baseline should be documented while the Web site is not yet running with Web Content Accelerator enabled, or with Web Content Accelerator running in Stealth Mode.

At each stage a new set of measurements can be taken and used for comparison with the baseline. The stages could be any milestone in the Web Content Accelerator deployment, for instance:

- Initial deployment with default settings
- Changes to rule options
- Changes to CSS settings
- Changes to caching behavior
- Changes to default image sets

Tools

There are many tools available to verify Web page load times and provide feedback on Web page structure. Some can be used in a very granular fashion, allowing testing on individual Web pages. Others are used for collecting metrics that can be correlated to the Web Content Accelerator-enabled implementation.

Page Speed and Structure

Many tools can test and provide information about your Web pages. Some are available as online services while some are available as an add-in for Web browsers such as Firefox or Chrome. Some typical examples follow, however your exact requirements may vary:

- WEBPAGETEST (www.webpagetest.org) is a free web site service that emulates browser behavior and retrieves your web page for analysis, presenting results in a cascade-style chart showing how a browser progresses through the page when rendering it.

- A simple process for ensuring that the site is as fast as possible is to work your way down the stepped list of objects on the chart, determining the most appropriate acceleration to apply for each object. For example, the start of the chart might show two redirects and then the page loading. The ideal action for this would be to rework the site such that the redirect is not used. Or you may be looking further down the chart at a script that loads on the page.
- YSlow (<http://developer.yahoo.com/yslow/help>) is a browser add-in developed by the Yahoo! Developer Network initiative. The software uses built-in rules to grade a web page across a range of performance indicators, from A (best) through F (worst) and provide suggestions to improve the web page score. It runs on Firefox and Chrome browsers.
- Google Page Speed (<http://code.google.com/speed/page-speed>) is another browser add-in also available for Firefox and Chrome browsers. The software grades web pages on a Page Speed Score from 0 (worst) to 100 (best). Google Page Speed also provides suggestions on how to improve the web page score.

Other Metrics

Some metrics require a longer data collection period to be useful. This means collection must start even before Web Content Accelerator is enabled.

- Google Analytics (www.google.com/analytics) is a free tool that can be used to collect metrics such as page load time, number of page views, page views per visits and bounce rate. Google Analytics requires a small script to be added to all pages in your web site. Results are visible a couple of days after installing the script, but you need to collect data for some time to allow for effective comparisons.
- Google Webmasters (www.google.com/webmasters) is another free tool that can be used to manage how Google sees your web site. As a bonus it provides a chart showing the average global web page load time for your entire web site, over a rolling window of six months. Google Webmasters requires site ownership authentication, which can be accomplished by a small DNS change, a configuration file added to your web server, or a meta tag added to your default web page.

Understanding Custom Acceleration Profiles



This section is not applicable to Web Content Accelerator Express.

Typically, the built-in Web Content Accelerator acceleration profiles provide good general-purpose optimization for your Web applications. However, there might be times when you need to define custom acceleration profiles in order to provide a more fine-grained control over optimization of specific elements of your Web site or application. For an overview of profiles, see [Web Content Accelerator Profiles](#).

The **Edit** page for a custom acceleration profile includes an additional control referred to as the **Acceleration Settings** dialog.

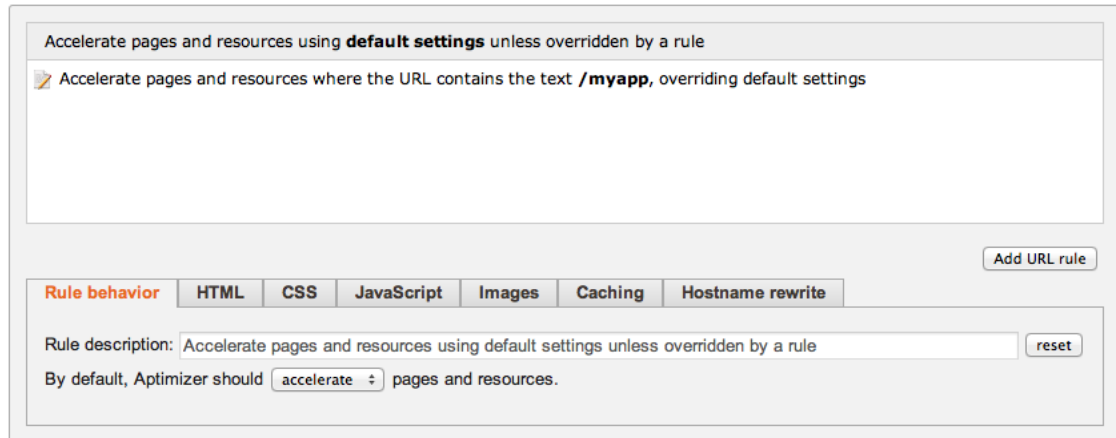

This contains controls and rules to handle optimization of different content types within your Web application. It is split into two main parts:

- The top part shows the hierarchical list of rules that are applied to your web content, usually based on URL location or browser type.
- The set of tabs below this represent the properties that apply to the current rule. As you highlight a particular rule, its properties are displayed in the tab set below it.

A **default settings** rule is provided for each Acceleration Profile that cannot be removed. This allows you to define the default behavior of the profile and configure the fall-back values for each of the property tabs. New rules can be added beneath this to further define optimization behavior and to override the default properties based on a specific URL (click **Add URL rule**). These newly added rules can be ordered according to priority or desired effect by clicking on the up or down arrows to the right of each rule bar. They can be removed altogether by clicking the delete button to the right.

In the rule properties section of the dialog, each displayed tab contains settings relevant to content that constitutes a typical Web application, such as CSS, JavaScript and images. The first tab, Rule Behavior, contains the general description of this particular rule and governs its overall behavior within the scope of whether to accelerate or exclude the content defined by the rule.

Profile Default Rules

In order to provide compatibility for mobile browsers of limited capability, both the Advanced and Basic profiles include settings to selectively disable some Web Content Accelerator features for these browsers.

Specifically, the following browsers have “image combination”, “stylesheet combination”, and “CSS image inlining” disabled by default:

- IE mobile 7
- Opera mini
- Opera mobile
- Blackberry

Additionally, certain optimizations are disabled for search crawler agents in order to allow cached versions of pages to be generic for all browsers. “Image combination” and “CSS image inlining” is disabled for the following search crawler user agents:

- bingbot
- googlebot



These profile default rules are not visible in the custom rules view of the Web Content Accelerator configuration.

Overriding Default Behavior

Each new URL rule added to the list has its own set of properties that can override the default behavior when a match is made. Each property tab contains an **Override** checkbox that enables or disables this mechanism for that particular property tab. Should you wish to provide an alternate configuration setting for a particular rule, click the Override checkbox to enable the settings for that tab. By default, all settings are disabled/greyed-out until the override checkbox is selected.

Rule Chaining

The default behavior in any given situation is for each request to pass through the list of URL rules and stop when a match is found. This stop-when-matched behavior can be overridden by selecting the **Allow settings for this rule to chain to other rules** checkbox within a rule.

If enabled, a matching request will not stop at that rule. Instead it will continue on to find a second rule match. Note, however, that this setting only remains in effect until a further match is found. At that point, if the second matching rule does not also have chaining enabled, the request will not attempt to match any further rules. If you wished to have all rules tested throughout your profile, regardless of how many matches occur, you would need to enable chaining on each of them.

Acceleration Settings

Each group of related optimization settings are shown on a separate tab. These are listed below.

Rule Behavior Tab

| Setting | Description |
|------------------|---|
| Rule Description | <p>A textual description of the current rule, automatically assembled from the basic rule behavior settings contained in this tab. For example, changes to the URL test string or rule mode will be automatically reflected in the descriptive text in this field. It is possible to override this text with your own description, however no further automatic updates will be made.</p> <p>To reset the description back to the default auto-generated string, click the reset button.</p> |
| Rule mode | <p>Web Content Accelerator can be set to accelerate or exclude all pages and resources identified by this rule.</p> <p>Accelerate mode is the default, and performs the desired optimization defined within the rule properties on a matching request.</p> <p>The alternative is to set the rule to exclude optimization for pages or resources that match the supplied URL test.</p> <p>A third mode, strip, strips out resource references where a match is encountered.</p> |

| Setting | Description |
|--|--|
| URL test | <p>These rules only apply to requests that match the specified text. The text is compared with the full URL including the hostname if the Match external resources box is checked, otherwise it is compared only with the URL path. You can specify a substring that must be contained in the URL, or a wildcard or regular expression that must match the entire URL.</p> <p>Before using regular expressions, read and understand the security considerations in Using Regular Expressions.</p> |
| Applies to externally hosted resources | <p>This setting allows you match against resources held external to the Web application. If enabled, the rule will only match requests for hosts that are not included in the Application Scope, and the string contained in the URL test field will be matched against the hostname and path contained in the request. For example, you may wish to exclude media files on your Web page that are included from an external media hosting Web site. If this is the case, you can select this option and specify a wild-carded string in the URL test field that includes the name of the hosting site in addition to the URL path of the media files you are interested in.</p> |
| Rule chaining | <p>Allow settings for this rule to chain to other rules. Please refer to the Rule Chaining section above for more details.</p> |

CSS Tab

| Setting | Description |
|---------------------------------|--|
| CSS and Stylesheet optimization | <p>None: Style sheets will remain in their original form wherever they appear.</p> <p>Optimize CSS Content: Style sheet blocks in the page and in external style sheets will have all redundant whitespace and comments removed.</p> |

| Setting | Description |
|-----------------------------------|---|
| | <p>...and combine consecutive stylesheets: Style sheets that appear as consecutive references (i.e. without inline style blocks or excluded style sheet links between) will be combined and each combined reference inserted to the location where the first style sheet in a set appears in the document.</p> <p>...and combine all stylesheets: All style sheets will be combined, no matter where they appear in the page. The new combined reference will be inserted at the top of the head section of the document.</p> |
| CSS background image optimization | The maximum allowable size (in bytes) of base64 encoded data to be inlined using data:uri notation or a MHTML reference. Images that exceed this limit will remain as URLs. |

JavaScript Tab

| Setting | Description |
|-------------------------|---|
| JavaScript optimization | <p>Enabled: Script files will have all redundant whitespace and comments removed.</p> <p>Disabled: Script files will remain in their original form.</p> |

Images Tab

| Setting | Description |
|----------------|--|
| Combine images | <p>Enabled: Images that appear as tags in the HTML are combined using one of the following techniques:</p> <p>CSS image spriting: Images are combined into an image sprite according to the image format.</p> <p>Image streaming: Images are combined into one or more image streams.</p> |

| Setting | Description |
|------------------|--|
| | Disabled: Images that appear as tags in the HTML are not combined. |
| Shrink images | <p>Images are shrunk where possible, removing unnecessary information such as metadata, redundant color information and in the case of JPEG images, reducing the quality to reduce the size of the files.</p> <p>If an image appears on a Web page in BMP format, the Traffic Manager automatically converts it to JPEG format to reduce its size. You can prevent this by using a rule to exclude the image from being processed.</p> |
| Resample quality | <p>The percentage quality level to resample lossy images to (0-100). If retaining the quality of your images is paramount, set this value to 100.</p> <p>The default is 85.</p> |
| Convert images | Allow images to be optimized to a different format than the original. The format can be chosen explicitly, or set to "Optimal", which chooses the best format automatically for each image. |
| Resize images | Resize images to a specified width and height in pixels. |

Caching Tab

| Setting | Description |
|-------------------------------------|---|
| Honor resource Cache-Control header | <p>Auto: Web Content Accelerator determines whether to cache a resource based on its content type. Static resources, such as style sheets and images are always cached, whereas dynamic resources, such as JSON-formatted API responses, obey the response's "Cache-Control" directives.</p> <p>Always: Web Content Accelerator obeys all "Cache-Control" directives in the response.</p> <p>Never: Web Content Accelerator caches all content it optimizes.</p> |

| Setting | Description |
|---|--|
| Version resource URLs | <p>Enabled: URLs at this location are versioned by rewriting the URL to contain a hash of the contents of the file. The cache expiry time for versioned URLs is 1 year.</p> <p>Disabled: URLs are unaltered and clients cache the item for the full Cache on browser interval before rechecking.</p> <p>For more information, see Resource Naming and URL Versioning.</p> |
| Mark resources as cacheable by intermediary proxies | <p>Enabled: Resources that are cacheable at this location will be marked with the “Cache-Control” public header that allows them to be cached by intermediary proxy servers.</p> <p>Disabled: Resources that are cacheable will be marked with the “Cache-Control” private header to prevent them from being cached by intermediary proxy servers.</p> |
| Optimize resources requested directly by their original URL and store them in the cache | <p>Enabled: If a resource such as an image or CSS stylesheet is requested by its original URL, enabling this option will cause Web Content Accelerator to optimize and cache the resource before returning it to the client. This can be useful if, for example, your site contains JavaScript that fetches images or other resources from your server after the page has loaded.</p> <p>Disabled: Directly requested resources are returned un-optimized and will not be cached by the Traffic Manager.</p> |
| Cache on browser | <p>The duration, in seconds, resources will be cached on the client’s browser before expiring. This is used as a sliding expiry to set the Expires header, meaning the client will cache the file for the specified number of seconds from when it receives it.</p> <p>This setting applies only to resources that are optimized and requested by their original URL.</p> |

| Setting | Description |
|--------------------|---|
| | This excludes combined resource sets or resources utilizing URL auto versioning. In these cases the URL of the resource (or resource set) is generated from a hash of the contents, so modifying the Expires header has the effect of altering the resource URL. This means that the resource would have to be re-requested on the strength of the changed URL. |
| Background recheck | The time, in seconds, after which a resource that is in the server cache will be marked for a recheck. When a resource that is marked this way is requested, the existing version in cache will be returned immediately, while a background task refreshes the cached version if it has been modified. |

Hostname Rewrite Tab

| Setting | Description |
|------------------------|--|
| URL hostname rewriting | Relocates resources from the current domain onto the specified host or URL root by rewriting all matching URLs. This can be specified as a single hostname (for example, cdn.example.com) or a full root URL with optional scheme and path components (for example, "https://cdn.example.com/images"). |

Understanding Optimization Techniques

This section discusses various optimization principles employed by Web Content Accelerator. The first part relates to the concept of "Web page speed rules" and how Web Content Accelerator applies those rules to optimize your Web content. This is followed by a discussion on a number of techniques Web Content Accelerator uses to apply optimization to Web applications.

Web Page Speed Rules

These broadly fall into four categories, each of which can be applied to your Web application in order to provide a better response to the client browser:

- Reduce the number of objects being loaded by Web page

- Reduce the size of everything sent to and from the server
- Cache as much as possible to speed up repeat views
- Reduce the time it takes for the server to respond to a request

The sections that follow describe each in more detail.

Reduce the Number of Objects Being Loaded by Web Pages

For each element on your Web page, the browser will issue a HTTP request to the host where the resource is stored. Browsers limit the number of simultaneous connections that can be established to each server; therefore fewer Web page elements mean a faster Web page load. It is this time optimization step that will accelerate Web page loading the most.

Web Content Accelerator automatically reduces the number of objects by combining files when appropriate, creating “combined resource sets” by resource type. Specific information regarding the most common types is shown below:

Image In-Lining and Combination

Images are important elements in every Web page. They can be separated into CSS background and HTML images, with different approaches for each type:

- CSS background images

CSS background images are referenced from the background property in a custom style sheet or directly in a style property within a Web page. To reduce the number of requests for these resources, Web Content Accelerator will convert them to base64 data and embed this in the style sheet file or HTML.

The exact acceleration behavior differs depending upon the browser:

- For Internet Explorer (version 6 and 7) the base64 data is served in a separate file, with the style sheet background URL referencing this file using MHTML notation;
 - For all other browsers, the base64 data is embedded directly into the CSS using the “data:uri” notation.
- HTML images

HTML images are images referenced from an `` tag in a page. To accelerate these images, Web Content Accelerator can create a combined CSS sprite that contains all images of a particular format.

Web Content Accelerator then attaches some CSS style information to the `` tag to reference this sprite as a background image, and sets the source attribute to reference a transparent GIF.

JavaScript Minification

Reducing the amount of superfluous content in JavaScript files run from within the HTML can help to improve overall page load time. Content such as redundant whitespace and comments, although useful from a software development perspective, serve no functional purpose in the operation of the page so are removed in order to reduce the file size.

Style Sheet Combination

Reducing the style sheet request count is an important step in accelerating the time a browser starts rendering a Web page. Combining style sheets is generally a safe and effective way of accelerating page load time.

Accelerating Third-Party Domain Content

By default, Web Content Accelerator applies Web page acceleration rules to elements served from the same Web subdomain from which the page is served. Consider the example of an image URL in the `` tag for the Web site "www.example.com":

| URL | Result |
|-------------------------------------|-----------------------------------|
| /images/sample1.jpg | Web Content Accelerator optimized |
| www.example.com/images/sample1.jpg | Web Content Accelerator optimized |
| images.example.com/sample1.jpg | Not optimized |
| images.otherexample.com/sample1.jpg | Not optimized |

It is possible to modify this configuration to include other Web subdomains, even third party domains, effectively accelerating partners' content required to display your Web pages.

Web Content Accelerator can rewrite these resource references to either:

- Combine the object into a CSS sprite set.

- Apply versioning (see [Resource Naming and URL Versioning](#)) to the original URL, which will be served from the domain host.

A technique to increase the number of concurrent resource downloads is “domain sharding”, where some of these resources are downloaded from different Web domains or subdomains. This approach provides more benefits than domain sharding, because every distinct Web domain name used on a Web page requires additional DNS resolution time and TCP connection establishment time. Also, the chance of some content being unavailable is greatly reduced, since this content is now being served from your Web server.

Reduce the Size of Everything Sent to and from the Server

By default, Web Content Accelerator works to automatically reduce the size of content sent from the server.

- Text based objects are compressed using the gzip compression algorithm.
- JavaScript and style sheet files are minified by removing all redundant whitespace characters and comments.
- Redundant image information (such as metadata) is removed, and JPEG images are, by default, resampled to 85% of their original quality.

Cache as Much as Possible to Speed Up Repeat Views

Browsers can locally cache resources for faster reuse on subsequent Web page visits.

Web Content Accelerator automatically applies cache headers to all resources, providing browsers with information needed to manage those resources. By default, Web Content Accelerator applies different cache durations to resources depending on how they are referenced, as shown in the following table:

| Condition | Cache for |
|---|-----------|
| Object is combined into a resource set | 1 year |
| Object URL was versioned by Web Content Accelerator | 90 days |
| Original object URL was requested | 1 hour |

Public Proxy Caching

Optionally, Web Content Accelerator can help leverage any intermediary caching proxy server, such as those commonly used in corporate environments and Internet service providers (ISPs). By using a specific attribute, Web Content Accelerator will add "cache-control: public" headers to all or any specific resources.

Marking resources as proxy cacheable can provide a significant improvement in both first view and repeat view load times for users who access a Web page on a Web site other users have already accessed.

Reduce the Time It Takes for the Server to Respond to a Request

This rule applies to the time it takes for your server to start sending a HTML response to your client's browser. As previously mentioned, this can be up to 20% of the Web page load time.

Reducing this time is directly related to your server, application design and maintenance. Possible solutions can involve scaling up (achieved by adding system resources such as processor and memory to existing servers), scaling out (achieved by increasing the number of server nodes to distribute workload over more nodes), code profiling and tuning, database tuning, sharding (distributing the database over multiple servers), Web server tuning and more.

This rule applies to your Web server and application, thus outside the scope of this chapter.

Resource Naming and URL Versioning

Web Content Accelerator will create a new identity for each "combined resource set" or "URL auto versioned resource" created in the process of accelerating your Web pages. This approach allows the Traffic Manager to inform the browser when a resource has changed rather than telling it to check back with the Traffic Manager every so often to see if it has changed. We do this by making the URL of the resource dependent on its content.

For example, a resource set could be named:

```
/optimized-gif-kjmMLxSEdXYqXt3coAasow4F=-ds3432d.gif
```

and an auto-versioned URL could look like:

```
/images/optimized-jpg-23dgdstds5563gfv=-P9vry3Uq22.jpg
```

The string of numbers and letters in these URLs represent a unique hash value of the settings, the content and any child resources that make up a particular resource. Whenever a setting is modified, any resources for which that setting applies will automatically be recalculated. Thus, any change to the content of a resource will also cause this unique value to change.

Under normal circumstances, where the Traffic Manager is simply serving pages without auto-versioning enabled, the following typical data flow is in operation:

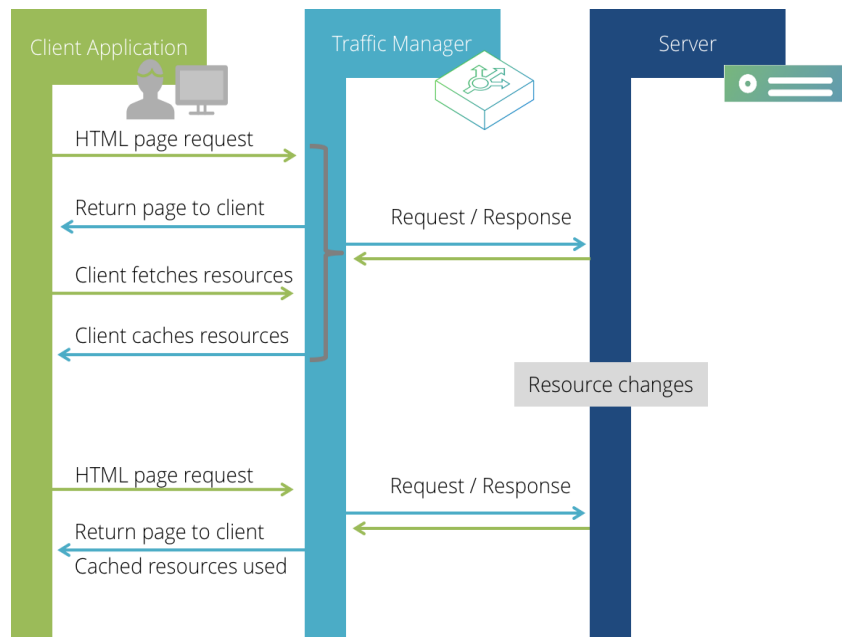

1. The client requests an HTML page through a service running on the Traffic Manager.
2. The client receives the HTML page back, with links to regular resources (for example, style sheets, images, and so on).
3. The client fetches these resources.
4. The Traffic Manager serves them from the back-end server, possibly optimized depending on the Web Content Accelerator settings used.
5. The client caches any available resources locally.
6. Some resource is changed on the back-end server for whatever reason (for example, bug fixing, a layout change, and so on).
7. The client requests another HTML page on the same website.
8. The client receives the HTML page from the Traffic Manager with a link to the same resources.

- The client is unaware of the change on the server, and refers to its own locally cached (and unexpired) versions of any identified resources and does not re-request them from the Web service.

As shown in the last step, one essential flaw with this scenario is that the client will wait a period of time before re-requesting a cached resource, which may or may not have changed. The client could therefore be using an out of date copy of a resource until some event occurs to prompt the re-request.

With auto-versioning enabled, the Traffic Manager provides the assurance that the client will always be using the most up-to-date copy of a resource contained in a Web page. The following data flow demonstrates this:

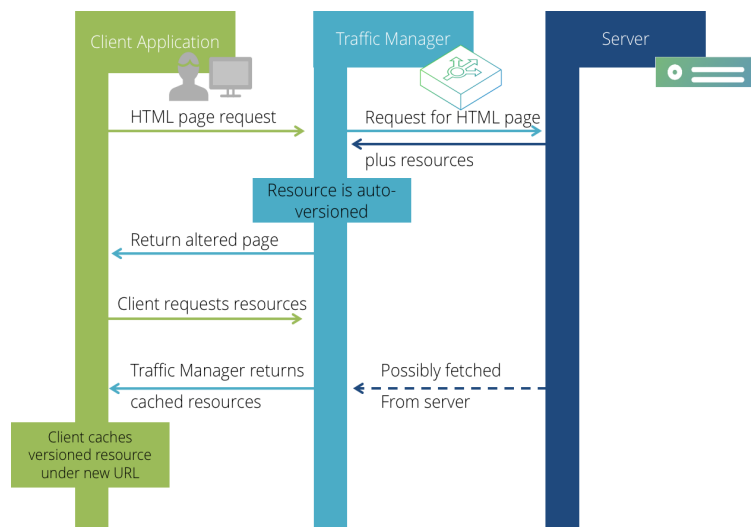

- The client requests an HTML page from a Web service provided through the Traffic Manager.
- The Traffic Manager notices the HTML page references one or more resources.
- The Traffic Manager fetches these resources (and possibly optimizes them, depending on the Web Content Accelerator settings), examines the content and creates a hash value based upon it.
- The Traffic Manager creates a new URL for such resources that includes the computed hash value, and replaces all references in the HTML page.
- The altered page is returned to the client.
- The client requests the in-page resources from the Traffic Manager, via the new URL.

7. The Traffic Manager serves the identified content from its cache (or fetches it from the back-end server if its not in the cache).
8. The client locally caches resources using the new URL.

Subsequent page requests are then served from the Traffic Manager with the test that the computed hash value of each resource has not changed (based on the resource content at the back end):

1. The client requests another HTML page.
2. The Traffic Manager observes that the contained resources have not changed on the back-end server and writes in the same computed hash-value URL as last time.
3. The client uses its cached copies of those resources.

Should a resource change on the back-end server, subsequent page requests will be affected by virtue of the computed hash-value being different. The following scenario occurs:

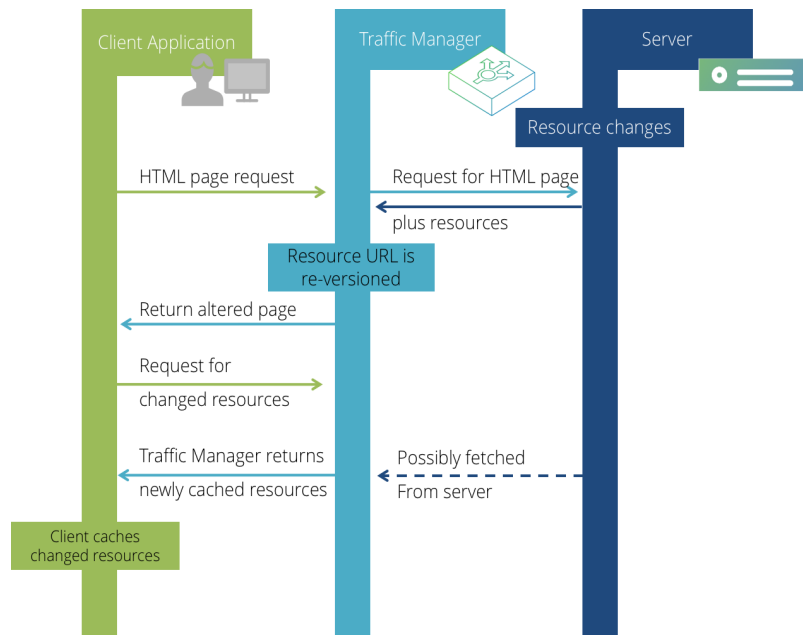

1. A resource change forces a re-compute of the content-based URL. One or more resources change on the back-end server.
2. The client requests another HTML page.
3. The Traffic Manager observes that the desired resource has changed on the back-end server and creates a new URL based on the new content - different to the previous one.

4. The client does not have a cache entry for the new URL, so it requests it from the Traffic Manager, which serves it back.
5. The client is immediately using the new version of any changed resource.

Using a Content Distribution Network

Content Distribution (or Delivery) Networks (CDNs) host some or all of your resources on servers that are geographically distributed, reducing latency between your Web server and the customer. For further information on CDNs, refer to http://en.wikipedia.org/wiki/Content_distribution_network.

You can leverage a CDN with Web Content Accelerator using the **URL rewrite to CDN** configuration setting on the Web Content Accelerator Profiles edit page (custom profiles only).

This setting instructs the Traffic Manager to rewrite the HTML for requests that match that rule so that resources are then downloaded from the domain provided by your CDN instead of your own Web server.

The Traffic Manager will automatically use the scheme (HTTP/HTTPS) of the incoming request when accessing a CDN host, but it is possible to manually specify the scheme and virtual path in the **URL rewrite to CDN** setting if required. This allows the scenario of switching all traffic to SSL if the target Web site is reverse proxied through another device that terminates the SSL connection.

Troubleshooting Web Content Accelerator



Certain UI controls and configuration options mentioned in this section do not apply if you are using Web Content Accelerator Express.

Controlling Unexpected Behavior

When the Traffic Manager encounters problematic or non-standard user-defined content, the Web Content Accelerator process could be forced into a failure state. If this occurs, the Traffic Manager records the failure with an error message in the event log and restarts the process.

In certain circumstances, error-prone content could force repeated failures and restarts of the Web Content Accelerator process. This can hinder the overall performance of the Traffic Manager and make troubleshooting efforts more difficult. Therefore, the Traffic Manager provides a “watchdog” capability to stem the effect of frequent failures by disabling the Web Content Accelerator process restart once a set limit has been reached.

To set your watchdog configuration, click **System > Global Settings > Web Content Accelerator**. This section contains the following settings:

| Setting | Description |
|-----------------------------|--|
| | <p>This is the maximum number of times the Web Content Accelerator process will be started or restarted within the interval defined by the optimizer!watchdog_interval setting. If the process fails this many times on one Traffic Manager, Web Content Accelerator will be disabled on all Traffic Managers in the cluster, and it must be restarted manually from the System > Diagnose page.</p> <p>If this limit is set to zero, Web Content Accelerator will never be disabled.</p> |
| optimizer!watchdog_interval | <p>The period of time (in seconds) after which a previous failure will no longer count towards the limit set by optimizer!watchdog_limit.</p> |



Most users should not have to use or modify these settings. If you do find that Web Content Accelerator fails frequently, contact your support provider.

For details about other Web Content Accelerator global settings, see [Other Configurable Global Settings](#).

Interaction with Other Traffic Manager Functionality

In practice, enabling Web Content Accelerator on your virtual server should present no interoperability issues with other Traffic Manager functionality. However, due to the nature of certain built-in protection and performance capabilities, it is important to understand the interactions between Web Content Accelerator and these other features.

Problems with Dependent Requests

The following diagrams demonstrate the consequences of what are termed “dependent requests”. These are requests that follow a Web page request handled by the Traffic Manager, for dependent resources contained within that returned page.

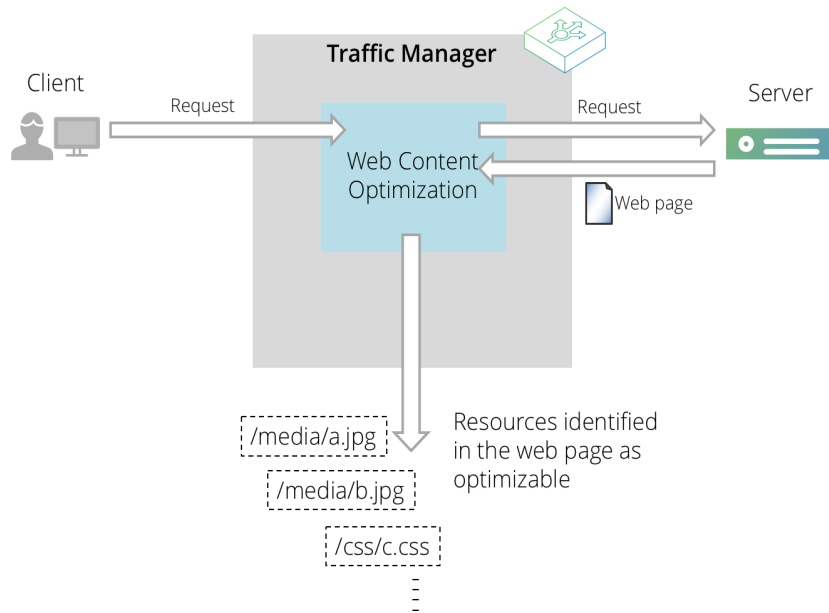

Initially, the client requests a Web page for a service handled by the Traffic Manager. Web Content Accelerator is enabled for this Web application and will attempt to identify resources that are potentially optimizable.

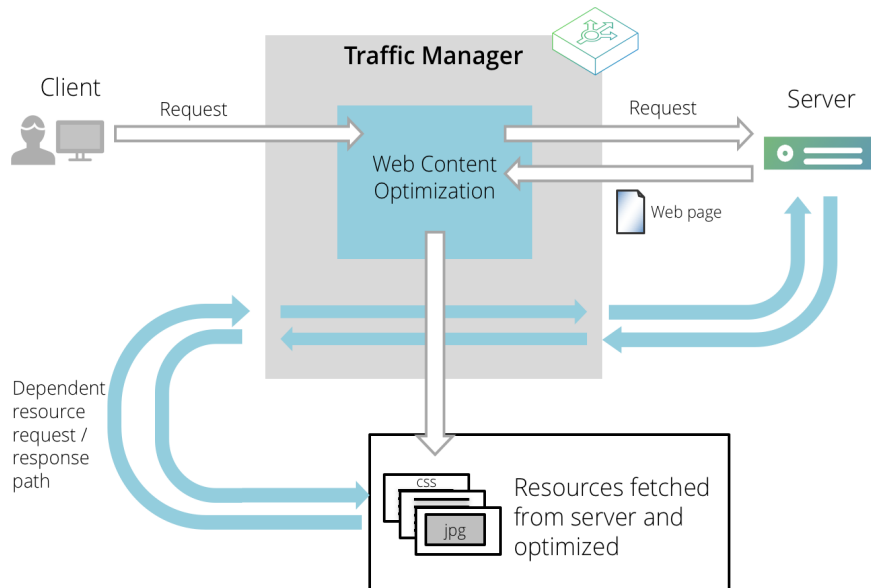

The Traffic Manager might then need to make a number of additional dependent requests in order to locate and provide the various resources that have been stripped or optimized out in order to improve the page load time of your application.

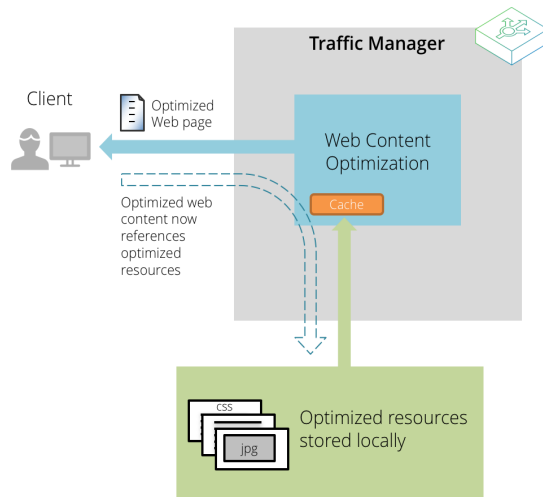

After they have been fetched, suitable resources are optimized and cached locally by Web Content Accelerator. Subsequent page requests contain modified URLs to optimized content, which can be served directly from the Traffic Manager.

Dependent requests are processed through the Traffic Manager as typical requests, with the usual processing applied. However these requests do not necessarily contain the same identifying headers, cookies and other elements of authentication as the requests and responses made directly through the Web Content Accelerator, so can cause potentially unexpected results.

The following sections highlight the issues surrounding the fetching of these dependent requests.

Service Protection

The fetching of dependent requests could in some cases trigger Service Protection classes to be activated (since the requests will come in bursts from one of the Traffic Managers in your cluster). This can be prevented by adding the appropriate Traffic Manager IP addresses to the list of **Allowed IPs** (also known as whitelisting) maintained within the Access Restrictions section of the class configuration. For further details about Service Protection features and capabilities, see [Service Protection](#).

TrafficScript Rules

The typical processing order for TrafficScript rules when Web Content Accelerator is enabled runs as follows:

- For a request:

Client request received -> TS request rules -> Web Content Accelerator -> Sent to back-end node

- For a response:

Response received from back end -> TS response rules -> Web Content Accelerator -> Sent to client



With respect to dependent requests, TrafficScript rules are run in the usual way.

TrafficScript rules that rely on the client IP address, browser headers, cookies, authentication data, or any other information pertaining to the client, could result in unexpected behavior due to the lack of such information in dependent requests.

Note also that use of the `http.stream.*` TrafficScript functions will prevent responses from being optimized.

SSL Decryption

The Traffic Manager cannot be used to optimize virtual servers that use SSL decryption and require client certificates. This is because a client certificate is not provided when Web Content Accelerator initiates fetches for additional resources.

Authentication

In Express mode, the Traffic Manager cannot be used to optimize any services employing authentication. In Enterprise mode, the Traffic Manager can optimize services using NTLM. No other client authentication methods are supported.

Content Caching

Web content that is passed through Web Content Accelerator and can be considered to be in scope with Web Content Accelerator will not be cached in the usual way within the regular Traffic Manager Web cache. Instead, it will be held and served from a dedicated Web Content Accelerator cache, designed to maintain local copies of optimized Web content/resources. To control this behavior, use the settings contained in the "Caching" tab on the **Web Content Accelerator Profile** edit page.

Runtime Errors

Runtime errors are generally server-related. You can get these errors due to server misconfiguration or third party interference (routers, firewalls, load balancers). In general you might not be able to access the Web site at all, or if you can access the Web site you might experience missing resources.

Symptom: An error page is displayed only when Web Content Accelerator is enabled; resources are served with a 400 or 404 http status; the server takes a long time to return Web pages even though the application pool is warm.

- **Problem:** A URL rewriter or other HttpModule is attempting to handle the Web Content Accelerator resource set URLs.
- **Resolution:** Exclude URLs containing /optimized-gif-*.gif from URL rewriting or processing by another HttpModule.

Symptom: The Web service works when accessed locally but not when accessed from external clients.

- **Problem:** A proxy or upstream device is blocking or altering /optimized-gif-*.gif URLs causing them to become invalid.
- **Resolution:** Allow requests for /optimized-* to pass through to the host server unmodified.

Symptom: Cannot see the comment "`<!-- Optimized for speed – Pulse Secure Web Accelerator -->`" in the HTML.

- **Problem:** When you use your browser's "View HTML Source" the comment "`<!-- Optimized for speed – Pulse Secure Web Accelerator -->`" is not present, indicating the Web page is not being accelerated.
- **Resolutions:**
 - Make sure Web Content Accelerator is enabled for the specific virtual server.
 - Make sure the URL is not being excluded by a rule set.
 - If Web Content Accelerator is running in Stealth Mode use the `?aptimizer=on` query string in the URL request.
 - If the URL is not being excluded, Web Content Accelerator is fully enabled, make sure `?aptimizer=off` is not used in the URL request.

Image Errors

You might observe image errors if your Web pages do not display images in their specified position or display images with incorrect size. Image errors can also be “invisible”, as it is the case when Web Content Accelerator creates new resource sets for every new visit to the page.

You can spot the problem with resource set creation by inspecting the elements on the page. You should see the most common elements being created once and served from the cache multiple times.

Symptom: A new sprite set seems to be created every time I visit the page.

- **Problem:** The list of images in the page is different every time, which causes Web Content Accelerator to create a new sprite set every page visit. This can cause excessive processor utilization, high cache memory usage, and overall reduced performance on the server.
- **Resolution:** Add a URL rule to include the dynamic images in an uncombined form (disable the setting **Combine HTML images into image sprites** in the **Images** tab).

Symptom: Images on the page are losing their padding or out of alignment on the page.

- **Problem:** Padding is being used to space the image from its neighboring UI elements.
- **Resolution:** Add a URL rule to include the dynamic images in an uncombined form (for example, disable the setting **Combine HTML images into image sprites** in the **Images** tab).

Symptom: One of the images appears much larger when Web Content Accelerator is enabled.

- **Problem:** The container that holds the image uses style sheet to resize the image from its native dimensions.
- **Resolutions:**
 - Modify the page template to include a width and height attribute on the element. This lets Web Content Accelerator know what size the image should be displayed at, and also helps the browser calculate the page layout more quickly, resulting in a faster rendering time.
 - Add a URL rule to include the dynamic images in an uncombined form (for example, disable the setting **Combine HTML images into image sprites** in the **Images** tab).

Symptom: Acceleration is working but there is a layout problem.

- **Problem:** This is normally style sheet or HTML image related.

- **Resolution:** Reduce the number of style sheet objects and HTML images. This problem typically requires the use of acceleration rules to work around whatever technique is causing this symptom to appear.

CSS Errors

You could have image errors if your Web pages do not display images in their specified position or display images with incorrect size. Image errors can also be “invisible”, as it is the case when Web Content Accelerator creates new resource sets for every new visit to the page.

You can spot the problem with resource set creation by inspecting the elements on the page. You should see the most common elements being created once and served from the cache multiple times.

Symptom: Internet Explorer does not apply background images defined in a style sheet.

- **Problem:** The cause is the security policy that Internet Explorer is enforcing. If an HTML page on one domain references a resource on a different domain and that resource type is rfc822 then the browser will load it but not process it since it does not know if it can be trusted. External resources on the same TLD as the page are implicitly trusted.
- **Resolution:** Change the CDN hostname to be a subdomain of the main Web site so that resources are implicitly trusted.

JavaScript Errors

It is important to ensure any JavaScript errors, as detected by most modern browsers, do not exist before enabling Web Content Accelerator. This will help determine if these problems are caused by any of the introduced optimizations. If in doubt, request the page again with Web Content Accelerator disabled. This will bypass the accelerator and you can then check if JavaScript errors exist regardless of the optimizations.

On Internet Explorer 9 you have access to Developer Tools and debug information. On Firefox and Chrome you can install the Firebug add-on and access similar information. Most browsers offer an identifying message/notification when JavaScript errors are encountered regardless of installed tools and plug-ins. This message is usually helpful in disclosing which script is causing problems and frequently also identifies the specific position or line number of the erroneous section of code.

Debugging JavaScript Errors

Because Web Content Accelerator allows you to apply rules to specific URLs, you can switch off certain optimizations for individual (or a group of) resources without compromising the default settings for your Web site.

To resolve JavaScript issues with Web Content Accelerator enabled you can perform one or more of the following:

- Disable the **JavaScript optimization** option on the **JavaScript** tab of any matching rules
- Identify which script is breaking and create a URL rule to exclude it completely from optimization
- You can verify Web Content Accelerator is causing JavaScript errors quickly by excluding all JavaScript optimization on your web site. Create a temporary URL rule to exclude all optimization for any URLs containing ".js".

Common JavaScript Errors

Symptoms: Scripts execute with unpredictable results.

- **Problem:** Errors due to an external script reference having been moved in the page.
- **Resolution:** If order-dependent code exists between the external script and other script files or an inline script block, then this may prevent normal functioning of the site. Best practice for building JavaScript libraries is to treat them as libraries of functions, and not execute any immediate code. This allows script to be combined to the maximum extent possible. To work around poorly designed script you can instruct Web Content Accelerator to exclude them entirely via a suitable URL rule.

Symptoms: Scripts fail to load and execute.

- **Problem:** JavaScript frameworks that dynamically load script libraries into the page.
- **Resolution:** These frameworks typically look for a reference to one of the scripts that they use, or will use some sort of registration function to inject the scripts that should be loaded. Since Web Content Accelerator refers to combined scripts using a surrogate URL, this can confuse frameworks that behave like this. The solution in this case is to either exclude these scripts, or transform the loading code such that it understands Web Content Accelerator modifications.

Symptom: Some JavaScript is not executed on a Web page when using the JavaScript async option.

- **Problem:** Some ad blocking software will incorrectly filter out the Web Content Accelerator code injected to asynchronously load and execute JavaScript.
- **Resolution:** Use a URL rule to exclude required scripts from the async code, or disable the option to load and execute JavaScript in asynchronous mode.

Other Configurable Global Settings

The Traffic Manager provides further configurable global settings at **System > Global Settings > Web Content Accelerator**. This section contains the following settings:

| Setting | Description |
|--|--|
| optimizer!max_original_content_buffer_size | <p>The maximum content size of a single back-end response that can undergo Web Content Accelerator optimization. Responses larger than this are returned to the client un-optimized.</p> <p>If the back-end response is compressed, this setting pertains to the compressed size of the response body.</p> |
| optimizer!max_dependent_fetch_size | <p>The maximum the size of a dependent resource (a resource that Web Content Accelerator has requested from the back end, as a piece of content currently undergoing optimization depends on it) that can be sent to, and processed by, the Web Content Accelerator sub-process. Any resource larger than this value is always ignored by Web Content Accelerator and returned to the client un-optimized.</p> <p>Set this field to zero to disable the limit.</p> |

You do not normally need to alter these settings. The Traffic Manager uses default values that typically provide a good level of performance on all systems.

Event Handling and Alerts

The event handling capability allows the administrator to configure precisely what actions the Traffic Manager should take if particular events occur.

Overview

An "Event Handler" specifies the actions the Traffic Manager should perform when an event of a particular type occurs. To configure an Event Handler, click **System > Alerting** in the Admin UI:

Alert Mappings

| Event Type | Actions |
|--|--|
| All Events | → Log to event log <input type="text" value="Select action..."/> |
| License Key Problem ✕ | → E-Mail Administrator ✕ <input type="text" value="Select action..."/> |
| <input type="text" value="Select event type..."/> | |
| <input type="button" value="Manage Event Types"/> | <input type="button" value="Manage Actions"/> |

Apply Changes

The Traffic Manager provides one built-in event handler that causes all events to be written to the global Event Log. This built-in handler and its "Log all Events" action cannot be deleted, but you can add additional actions if required.

You can add additional event handlers, such as the handler illustrated in the diagram, that sends an email when there is a problem with a license key. Start by selecting the Event Type from the drop-down box, then select the actions that should be performed when an event of that type occurs.

When you create an Event Handler, you can optionally add the internal action "Bypass event log". Consequently, any events that are processed by that Event Handler are not logged to the global Event Log:

Events that match the "Connection Failures" Event Type are directed to the Syslog action, and are not logged to the Traffic Manager Event Log.

| Event Type | Actions |
|---|---|
| All Events | → Log to event log <input type="text" value="Select action..."/> |
| Connection Failures | → Bypass event log Syslog <input type="text" value="Select action..."/> |
| <input type="text" value="Select event type..."/> | |
| Manage Event Types | Manage Actions |

Event Types

The Traffic Manager can respond to a wide variety of events, such as node failures, Traffic IP address transfers, Service Level failures and custom events raised from a rule. For convenience, individual events are grouped into a number of predefined types, and you can create new Event Types as required.

| Event Type | Description |
|------------------------------|---|
| All Events | Includes all of the events that the Traffic Manager can detect; a built-in handler logs all events that match this type to the global Event Log. |
| Critical Problem Occurred | Includes all of the events that indicate a serious problem, including internal failures, node failures, IP transfers (because a Traffic Manager has failed) and other hardware problems. |
| Critical Problem is Resolved | Includes events that indicate that a problem that was raised in the "Critical Problem Occurred" Event Type has been resolved; for example, a failed node has started working again. If you configure the Traffic Manager to send an email message when a problem occurs, Ivanti recommends you also configure the Traffic Manager to send an email message if the problem is resolved and intervention is no longer necessary. |
| Default Events | Included for compatibility with earlier versions of the Traffic Manager. This event type includes all of the events that would cause the Traffic Manager to send an email message or raise an SNMP trap. |

| Event Type | Description |
|------------------------|--|
| | When the Traffic Manager is upgraded from an earlier version, if necessary the upgrade process adds an Event Handler to preserve the earlier behavior. |
| Infrastructure Problem | These events are raised if the Traffic Manager detects a problem with an item of infrastructure; for example, if a server becomes uncontactable. |
| Service Problem | These events are raised if a problem is detected that could impact the successful delivery of a service. |

To view the Event Types, click **Manage Event Types**.

Creating New Event Types

You cannot modify the built-in Event Types, but you can make a copy that can be edited, or you can create new Event Types from scratch.

For example, suppose that you use the Traffic Manager to manage several services, and you wish to create an Event Type that is matched when a particular service fails. You could then use that Event Type to create an event handler that emails the individual responsible for that particular service.

To do this, create a copy of the "Service Failed" Event Type, and edit the copy so that it is only matched when particular virtual servers, pools and nodes raise events. Perform the following steps:

1. Click **Manage Event Types**, and click the "**Service Failed**" Event Type.
2. You cannot modify this Event Type, but you can make a copy; Use the "Make a Copy of this Built-in Event Type" section to create a new Event Type called "Custom Service Failed".
3. The Traffic Manager presents the **Edit** page for your new Event Type. Events are arranged in a tree structure; you can expand the nodes in the tree to see all of the events that the Traffic Manager can detect. The particular events that the Event Type matches are opened so that they can be easily seen.
4. Edit the new Event Type. You can change the list of health monitors, nodes, pools, rules, virtual servers, and other objects that raise events so that the Event Type is only matched when the objects relating to your specific service raise events.

- To apply your changes, click **Update**. Then create an appropriate Event Handler for the new "Custom Service Failed" Event Type.

Actions

When an event handler is triggered, the Traffic Manager will invoke the actions configured for that handler.



The Traffic Manager contains three built-in actions: E-Mail, SNMP Trap, and Syslog. Note that on a new install of the Traffic Manager, the E-Mail and SNMP Trap actions are not completely configured (you must first edit them to specify the required settings). However, when the Traffic Manager is upgraded from an earlier version, these settings are preserved.

You may create additional actions of the following types:

| Type | Description |
|----------------------|---|
| E-Mail | <p>This action sends a report of the event(s) that triggered the handler to the email addresses configured in the action.</p> <p>You can create several E-Mail actions with different email addresses, and use this to configure the Traffic Manager to email different individuals for different Event Types.</p> |
| Log to external file | <p>Events are always logged to the global event log, but this action can be used to additionally log events to a named log file.</p> <p>The format used is the same as the format used in the global event log. This action is useful when creating a dedicated log of particular events.</p> <p>Traffic Manager appliance/cloud users: When using this facility on a virtual or cloud instance, you should ensure your file is kept within ZEUSHOME. When applying an upgrade, all user-created files and directories outside of ZEUSHOME are likely to be lost.</p> |
| Log to syslog | <p>This action sends a message to the syslog daemon on the named server.</p> <p>This action can be used to send particular events to an external monitoring and management tool that can accept syslog messages.</p> |

| Type | Description |
|------------------|--|
| Program | This action runs a script or other program that you have uploaded to the Traffic Manager system using the Upload and Manage Programs button on the action's Edit page. For an example program, refer to Calling a Program or Script . |
| SNMP Notify/Trap | This action sends an SNMP Notify or Trap to the named SNMP receiver application on the host specified. Traps are defined in the Traffic Manager MIB, which you can download from the action's Edit page. The Traffic Manager supports SNMP v1, v2c, and v3. The configurable settings for this action are dependent on the version you specify on the Edit Action page, and directly mirror the available settings on the System > SNMP page (SNMP command responder options). For more details, see Monitoring Performance Using SNMP . |
| SOAP Callback | This action sends a SOAP message to the named server. For an example of a SOAP action and a server that handles it, see Sending a SOAP Message . |

On the **Alerting** page, click the **Manage Actions** link to edit actions and create new actions.

You can also apply the internal Action "Bypass event log" to prevent events being logged to the global event log.

Testing Actions

When you create or edit an action, you can invoke it immediately with a 'test' event. This is a useful way of testing the correct configuration and operation of your actions.

Configuring an Event Handler

Before you configure an event handler, you will need to create an Event Type that matches the events you would like to trigger the event handler, and create an Action that performs the correct task, such as sending an email.

The event handler links the Event Type with one or more actions that should be invoked when an event that matches the Event Type is raised.

To configure an event handler, go to the **System > Alerting** page. Select the Event Type from the drop-down list to create a new event handler, then select the Actions you wish to be invoked from the drop-down in the entry for that event handler.

Press **Update** when you have completed your changes.

Duplicate Events

An event may match several Event Types, and therefore trigger several event handlers. If the same action is configured on each of these handlers, it will be invoked multiple times.

To reduce the volume of small emails sent, the E-Mail action is not triggered immediately, but will gather email messages and send them at 30 second intervals. You can configure this behavior of the email action in the **System > Global Settings** page, in the "Other Settings" section.

If a minor event is raised several times in quick succession, the Traffic Manager will suppress the repeated events. Major events are never suppressed in this way.

Custom Actions

Calling a Program or Script

The Program action is used to run a program or script that you have uploaded to the Traffic Manager. Programs and scripts are uploaded using the **Catalogs > Extra Files > Action Programs** page.

When this action is invoked, the Traffic Manager will execute the program in the background, passing it command line arguments that identify the event that triggered the action.

The Traffic Manager passes the following arguments to the program or script:

- Any command line arguments you have configured in the action (optional).
- An argument named "eventtype" that provides the name of the event handler that invoked the action that executed the program.
- The event description; this is in exactly the same format as the log line for the event that is written to the event log.

For example, if a TrafficScript rule raises an event named TestEvent, and this is caught by an event handler named "My Event Handler" which invokes a Program action, the program will be called as follows:

```
programname "--eventtype=My Event Handler" \  
  "INFO TrafficScript/TestEvent CustomEvent rules/<rulename> \  
  vservers/<vservername> <description>"
```

Note that the script is given two arguments (linebreaks have been inserted for readability).

Sending a SOAP Message

A SOAP action sends a SOAP request to the proxy configured in the action. The SOAP message conforms to the WSDL specification in:

```
ZEUSHOME/zxtm/etc/wsd1/AlertCallback.wsd1
```

You can download this file from the **Actions > Edit** page when you edit a SOAP action. This specification is documented in the Traffic Manager Control API documentation.

The SOAP request uses the interface `http://soap.zeus.com/zxtm/1.0/AlertCallback`, and invokes the method `eventOccurred`, passing it the following arguments:

- The name of the Traffic Manager machine that raised the event (type `xsd:string`).
- The time of the event, in the `xsd:dateTime` format.¹
- The severity of the event (of the enumeration type `AlertCallback.Severity`).
- The tag that identifies the event (of the enumeration type `AlertCallback.Tag`).
- An array of tags; this is empty and reserved for future use.
- An array of objects (type `AlertCallback.ObjectArray`); these objects (type `AlertCallback.Object`) describe the object that was responsible for raising the event (such as a node or rule).

Some events will reference multiple objects. For example, an event raised from a TrafficScript rule will contain three objects that identify the event name, the rule and the virtual server running the rule.

¹<http://www.w3.org/TR/xmlschema-2/#dateTime>

- A human-readable description of the event (type xsd:string). This is predefined for most events, but when an event is raised by the TrafficScript function `event.emit()`, the description contains the message provided by TrafficScript.
- Additional data provided by the action (type xsd:string).
- The name of the Event Handler that invoked the action.

The following Perl CGI script implements a simple SOAP consumer for the AlertCallback messages; this responder logs the details of the message to a local file. You can install this CGI script on a suitable Web server (equipped with Perl and the SOAP::Lite Perl modules), then configure a SOAP action, setting the proxy value to the URL of the CGI script:

```
#!/usr/bin/perl

package AlertCallback;

sub _addSerializerForEnum($;$)
{
    my ( $xsdtype, $ns_prefix ) = @_;
    $ns_prefix = "zeusns" unless $ns_prefix;

    $func = "SOAP::Deserializer::as_{$xsdtype}";
    *$func = sub { return $_[1] };
}

BEGIN {
    _addSerializerForEnum( "AlertCallback.Tag" );
    _addSerializerForEnum( "AlertCallback.ObjectType" );
    _addSerializerForEnum( "AlertCallback.Severity" );
}

sub eventOccurred($$$$$$$)
{
    my $self = shift;
    my( $stm, $time, $severity, $tag, $tags, $objects, $desc, $additional, $handler ) =
    @_;

    open LOG, ">>events.log" or die( "Couldn't open log events.log: $!" );

    print LOG "$stm - $time - $severity: $tag [";
```

```
print LOG join ', ', map { "$_->{type}:$_->{name}" } @$objects;
print LOG "]" $desc ($additional); Event handler: $handler\n";

close LOG;
}

package main;

use SOAP::Transport::HTTP;

SOAP::Transport::HTTP::CGI
  -> dispatch_with( { "http://soap.zeus.com/zxtm/1.0/AlertCallback/" =>
'AlertCallback' } )
  -> handle;
```

If your action is invoked by multiple different events, you may wish to determine the precise event based on the tag value in the SOAP message. You can do so by matching the description of the event in the event tree (when you configure a custom Event Type) with the description in the WSDL file to determine the value of the `AlertCallback.Tag`.

Raising Events from TrafficScript or Java Extensions

You can raise an event from within a TrafficScript rule or a Java Extension. The appropriate event handlers are run asynchronously, in the background, and the TrafficScript rule or Java Extension does not block.

To raise an event, use the `event.emit(event_name, event_message)` function (TrafficScript) or the `emitEvent(event_name, event_message)` function (Java).

To invoke an action based on an event raised using `event.emit()` or `emitEvent()`, create an Event Type that includes Custom Events. You can choose to match all custom events, or just specific events:

▼ Basic Settings

These settings allow you to specify which events make up this event type.

Name:

Events: **Events** Unfold All / Fold All

- Cloud Credentials
- Configuration Files
- Fault Tolerance
- General
- GLB Services
- Java
- License Keys
- Locations
- Monitors
- Pools
- Rules
- Service Protection Classes
- SLM Classes
- SSL Hardware
- Traffic Managers
- Virtual Servers
- Custom Events**

Custom events can be triggered using the TrafficScript rule 'event.emit'

No custom events
 All custom events
 Some custom events...

Add custom event

The names of the specific events in the Event Type should match the name used when the event was raised in the TrafficScript rule:

```
# raise an event named "TestEvent1", to be caught by an Event
# Type containing a custom event called "TestEvent1".

event.emit( "TestEvent1", "The request was ".$url );
```

Example

A simple intrusion detection system used to ban all remote clients that attempt to access a privileged URL:

```
# A TrafficScript rule that detects unauthorized
# accesses and raises an event.

$path = http.getPath();

if( string.StartsWith( $path, "/secure/admin" ) ) {
    $ip = request.getRemoteIP();
```

```
    if( !string.ipMaskMatch( $ip, "10.0.0.0/8" ) ) {  
        event.emit( "UnauthorizedIP", "IP: ".$ip );  
    }  
}
```

To use this example, create an Event Type that contains the custom event named "UnauthorizedIP", and an event handler based on that Event Type.

The event handler could then invoke a custom program action that updates the intrusion detection rules to ban connections from that IP:

```
#!/usr/bin/perl -w  
  
# An Action script to process event messages raised by  
# the above TrafficScript rule.  
  
my $logLine = $ARGV[1] or exit;  
  
$logLine =~ /IP:([\d]+\.[\d]+\.[\d]+\.[\d]+)/;  
my $ip = $1;  
  
open OUT, ">>/tmp/events.log" or die $!;  
print OUT "The bad IP was $ip\n";  
close OUT;  
  
# reconfigure upstream firewall, or the  
# Traffic Manager's banned IP list to ban access  
# from $ip
```

Configuring System Level Settings

Traffic Manager hardware appliances, virtual appliances, cloud instances, and certain software variants contain a number of additional configuration pages to manage settings such as network configuration, and time and date. On these variants, the Traffic Manager software performs a number of additional system checks and tests normally handled at the operating system level, such as checking the integrity of various operating system components and features.



This chapter applies only to certain Traffic Manager product variants. Refer to your product specifications for further details.

For initial setup and configuration instructions, including details about how to reset the Traffic Manager to its initial factory configuration, see the Pulse Secure Virtual Traffic Manager: Installation and Getting Started Guide applicable to your product variant.

Network Configuration



The features described in this section might vary depending on your product variant. Refer to your product specifications for further details.

Use the **System > Networking** page to configure your Traffic Manager hostname, network interfaces, DNS, routing, IP forwarding, and NAT settings.



The settings you configure on this page apply only to the local Traffic Manager instance whose Admin UI you are accessing. The exception to this is "Return Path Routing", which is applied across your Traffic Manager cluster. If you want to inspect or configure the network settings for a different Traffic Manager in your cluster, use the Admin UI for that instance.

Configuring the Hostname and IP Addresses

The hostname uniquely identifies your Traffic Manager system within your cluster, and the IP addresses identify each active network interface on the system. If you do not use a management port, configure your local DNS to resolve the hostname you specify to a permanent IP address on the Traffic Manager system.

Typically, the first network interface (eth0) is designated as the management port, although the hostname you specify does not need to resolve to the IP address on that interface. The Traffic Manager only accepts and transmits management information on the management IP address, and the corresponding interface should be connected to a secure network, separate from networks that route public internal or external traffic. Additional network interfaces are used to manage external or internal traffic.

If you chose not to use a management port, the Traffic Manager accepts management traffic on all interfaces, and the hostname you specify must resolve to one of the IP addresses active on the Traffic Manager system.

The Pulse Secure Virtual Traffic Manager: Installation and Getting Started Guide applicable to your product variant describes which interfaces are present on your Traffic Manager, and how they are numbered.

Using DHCP



This section is applicable only to virtual and hardware appliance product variants.

The Traffic Manager supports the use of DHCP (Dynamic Host Control Protocol) for managing the basic networking settings of your Traffic Manager system. You can configure each network interface to use either DHCP or the static settings you specify manually.

To use DHCP, tick the "DHCP" option against the network interfaces you want to control. Click **Update** to apply your changes.

Interfaces under the control of DHCP are greyed out and cannot be edited.

You cannot enable DHCP on any interface configured to host Traffic IP addresses. Nor can you change the DHCP status for the interface through which you access the Admin UI.

▼ Hostname and IP addresses

Name (hostname.domainname) of the appliance.
Hostname:

| Interface | IP Address | Netmask | MTU | DHCP | Remove |
|------------------------|--|---------------------------------|-----------------------------------|-------------------------------------|--------------------------|
| Management Port (eth0) | <input type="text" value="10.62.136.160"/> | <input type="text" value="18"/> | <input type="text" value="1500"/> | <input checked="" type="checkbox"/> | |
| eth1 | <input type="text" value="10.62.135.155"/> | <input type="text" value="18"/> | <input type="text" value="1500"/> | <input checked="" type="checkbox"/> | |
| eth2 | <input type="text" value="10.62.165.99"/> | <input type="text" value="18"/> | <input type="text" value="1500"/> | <input type="checkbox"/> | <input type="checkbox"/> |

Add IP Address:
Interface: **IP Address:**
Netmask: **DHCP:**

If you intend to use DHCP with your Traffic Manager deployment, Ivanti recommends that your network infrastructure is configured with long-life IP reservations for each interface in your system. IP address renewal after lease expiry can cause service interruption and communication issues in your Traffic Manager cluster.

If you specify one or more interfaces to use DHCP, the Traffic Manager also attempts to obtain settings automatically for your gateway, name servers, and search domain. Any settings you enter manually are overridden by DHCP-derived values, if available.

ATTENTION

Routing features such as RHI and RPR can be affected by the use of DHCP enabled interfaces. Ivanti strongly recommends that you consult your network administrator or service provider for details.

Configuring Interface Settings



This section is applicable only to certain product variants. Consult your product specifications for details.

By default, the Traffic Manager auto-negotiates network settings with the switch each interface is connected to.

It is sometimes necessary to manually specify the interface settings. For example, some switches might fail to negotiate the fastest speed they support.

To disable auto-negotiation, click **System > Networking > Ethernet Speeds**. For each applicable interface, set **Auto-negotiate** to "No". Then, use the **Duplex** and **Speed** drop-down lists to manually select the required interface settings. Click **Update** to save your changes.

Trunking/Bonding

If you configure the same IP address on multiple physical network interfaces, the Traffic Manager makes the interfaces members of a trunk (applicable only to virtual appliances). To use trunking, make sure your switch supports IEEE 802.3ad. Your switch documentation might refer to this feature as link aggregation, bonding or trunking.

Configuring VLANs



It is not possible to configure VLANs through the Traffic Manager Admin UI for virtual appliances running on the Microsoft Hyper-V hypervisor. If you need to enable VLANs in this scenario, you should configure them directly through the Hyper-V Manager application on your Windows Server workstation. Refer to your Hyper-V documentation or support provider for further information.

You can use the Traffic Manager Admin UI to configure VLANs on any of the network interfaces or bonded/trunked interfaces on your Traffic Manager.

To configure a VLAN

1. Access **System > Networking > Virtual LANs**.
2. Add a Virtual LAN interface to the appropriate physical interface:

The screenshot shows the 'Virtual LANs' configuration page. At the top, there is a header 'Virtual LANs' with a dropdown arrow. Below the header is a sub-header 'Add Virtual LAN interfaces on top of your existing physical interfaces.' Below this is a table with three columns: 'VLAN ID', 'Physical Interface', and 'Remove'. The table contains one row with '7' in the 'VLAN ID' column, 'eth1' in the 'Physical Interface' column, and a checkbox in the 'Remove' column. Below the table is a section titled 'Add New VLAN Interface:' with two fields: 'Interface:' with a dropdown menu showing 'eth0' and a downward arrow, and 'VLAN ID:' with an empty text input field.

| VLAN ID | Physical Interface | Remove |
|---------|--------------------|--------------------------|
| 7 | eth1 | <input type="checkbox"/> |

Add New VLAN Interface:
Interface: eth0 ▼
VLAN ID:

3. Configure the networking (IP address and subnet) on the new VLAN:

| Interface | IP Address | Netmask | MTU | DHCP | Remove |
|------------------------|---------------|---------|------|-------------------------------------|--------------------------|
| Management Port (eth0) | 10.62.136.160 | 18 | 1500 | <input checked="" type="checkbox"/> | |
| eth1 | 10.62.135.155 | 18 | 1500 | <input checked="" type="checkbox"/> | |
| eth2 | 10.62.165.99 | 18 | 1500 | <input type="checkbox"/> | <input type="checkbox"/> |

Add IP Address:

Interface:
 IP Address: Netmask: DHCP:

Virtual LANS

Add Virtual LAN interfaces on top of your existing physical interfaces.

Any traffic that is routed out through the VLAN interface is tagged with the VLAN ID.

Configuring Your DNS Settings

The Traffic Manager will query a local DNS server for inter-cluster communications, when resolving node names to IP addresses, when communicating with external services and whenever access restrictions or other configuration required it to resolve the IP address of incoming network connections.

You will need to configure your Traffic Manager system with the IP addresses of one or more local DNS servers. These are normally configured when you first install the Traffic Manager, but you can edit this configuration and add fixed host-to-ip-address mappings using **System > Networking > DNS**.

Configuring Routing

Your Traffic Manager routes traffic through the most appropriate network interface according to the IP addresses you have assigned to these interfaces. Ivanti recommends you also configure a default gateway to which the Traffic Manager can forward non-local network traffic.

ATTENTION

Your default gateway is used in network connectivity tests, as described in [Configuring Fault-Tolerance](#). It should reside on the network used for external (incoming) traffic. Do not specify a gateway that resides on the management network, or configure the **flipper!frontend_check_addrs** with more appropriate IP addresses.

If necessary, you can manually add additional routes to non-local networks when the default gateway is not appropriate. You must specify the non-local network (destination and netmask), the local gateway to that network (optional) and the interface to use to access the non-local network.

These settings are managed in **System > Networking > Routing**.

Configuring Return Path Routing



The settings in this section are not unique to a single Traffic Manager and are replicated to all other Traffic Manager instances in your cluster.

Typically, you do not care which route data packets take to get to their destination after leaving your network, as long as they arrive.

Traditional routing algorithms examine the destination address of a data packet and send it to the router that is believed to be the lowest-cost path to that destination. In cases in which two or more routes exist between your Traffic Manager and the Internet, the route from client to server can be different from the route from server to client. Normally this does not matter, provided that both are still receiving the packets they expected.

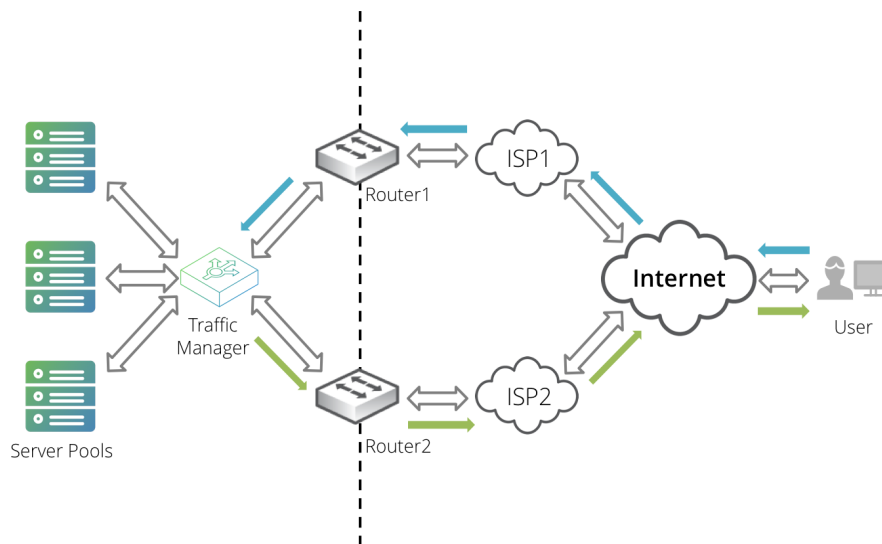

However, in some cases you might need the outbound path to correspond to the inbound path. For example, if there is a stateful firewall or NAT router in the path, the device needs to handle packets in both directions; otherwise, it drops packets that do not belong to a connection it knows about. Alternatively, you could be using two ISPs for load balancing (in addition to redundancy). If all server-to-client traffic flows through the same ISP, it can cause an unbalanced load.

One solution to this problem is to install a gateway router as the default gateway for the Traffic Manager. The gateway router forwards packets to the correct ISP using its own connection tracking.

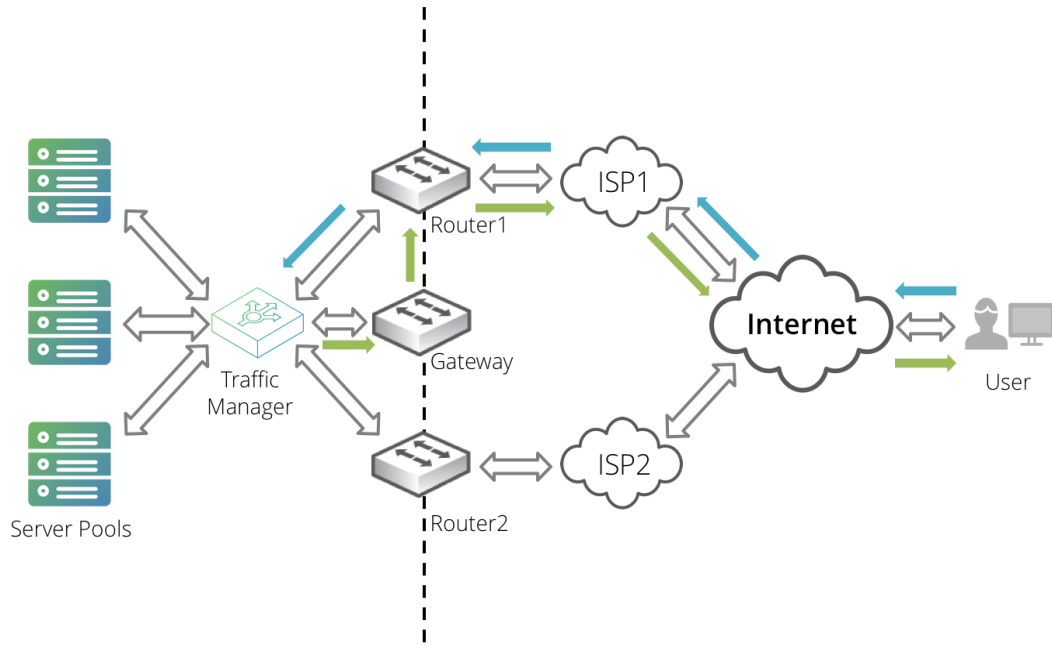

If this solution is unachievable in your network infrastructure, you can use the Return Path Routing feature of the Traffic Manager appliance to assist in providing the correct return route.

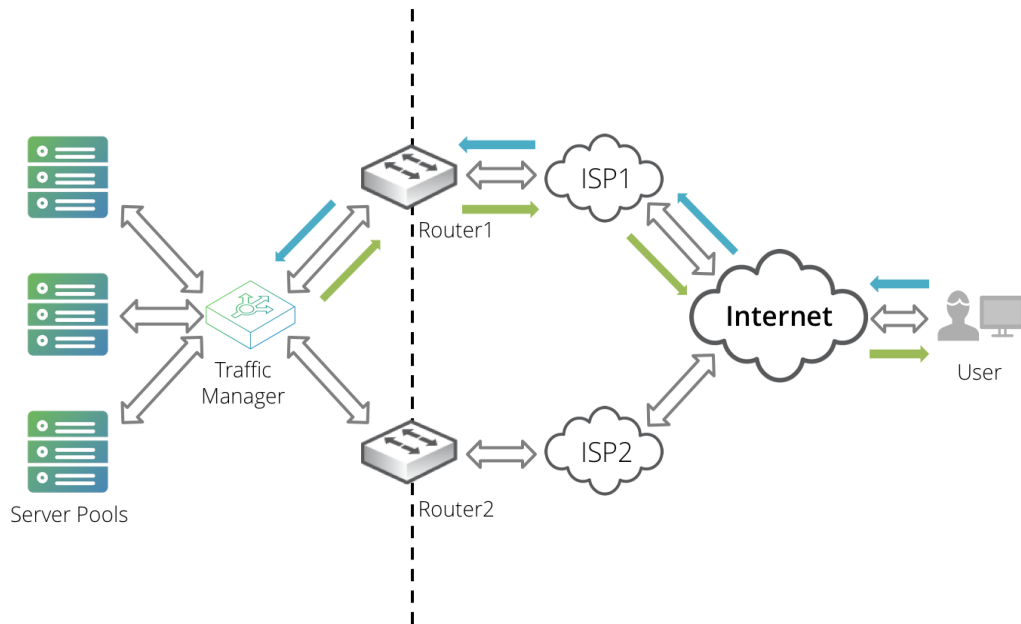

i The Traffic Manager can provide only return path routing back through an initial router hop. You are responsible for ensuring that your network is capable of providing the necessary onward routing back to the client.

The Traffic Manager uses the connection tracking features of "netfilter" to route return packets through the required router. When the Traffic Manager receives a new connection, it uses the MAC address in the Ethernet packet header to identify which router the client connected through. The Traffic Manager uses this address to label all packets belonging to the connection with a tracking mark.

When the Traffic Manager sends response packets back to the client, the existence of the tracking mark triggers an IP forwarding rule that sends the packet to the correct router instead of the default gateway or static route.

The Traffic Manager applies Return Path Routing to the following outgoing data packets:

- Packets in TCP connections initiated by a client.
- Packets in auxiliary TCP connections initiated by the Traffic Manager in respect of a TCP connection initiated by a client for certain protocols, such as FTP.
- UDP responses associated with a UDP request from a client.



To ensure correct return path routing of all FTP connections, configure the virtual server handling the traffic to listen on the default FTP port (21).

The following are excluded:

- Other TCP connections initiated by the Traffic Manager.
- Other UDP packets.
- All data handled by virtual servers operating with the SIP (UDP) or SIP (TCP) protocols.

ATTENTION

Connection tracking has a significant performance overhead; therefore, you should enable return path routing only if your network infrastructure requires it.

To use this feature, identify the routers in your network infrastructure that you want to use for return path routing. For each, determine the IPv4 (and IPv6, if applicable) address and MAC address of the interface that the IP is raised on. Your router configuration interface might display this information. Alternatively, use network tools such as "ping," "arp," and "tcpdump."

If the Traffic Manager is connected to the router via multiple VLANs, a specific network interface corresponding to a VLAN can be selected to distinguish the return paths for the different VLANs. The network interface "any" means any network interface on the Traffic Manager. If there are multiple return path routings with the same MAC address but one has "any" interface and the others have a specific network interface, the routing with a specific network interface is a higher priority match.

Add this information to the configuration table in **System > Networking > Return Path Routing**. This table is replicated to every Traffic Manager instance in your cluster.

To enable Return Path Routing, click the **Yes** radio button and then click **Update**.



You can find errors and warnings due to problems with validation or communication in the event log. However, beyond the initial router connection, the Traffic Manager is unable to detect whether data packets were received through the expected return route. Ivanti recommends performing additional network testing to ensure that packets are being received per your requirements.

Configuring IP Forwarding and Network Address Translation (NAT)

Depending on your network topology, the Traffic Manager can function as a network gateway for your back-end nodes or other devices on your network. For example, if you use IP Transparency, you must configure your back-end nodes to route outbound traffic through the Traffic Manager (see [Routing Configuration](#)).

When the Traffic Manager (or any other network device) acts as a gateway, it forwards traffic from the source nodes to their destination, and forwards responses back to the source nodes.

If all of the traffic forwarded by the Traffic Manager originates from sources with publicly routable IP addresses, there are no complications. All hops in the link between the source and destination know how to route the responses back to the source IP addresses.

However, it is quite common to locate your back-end nodes on a private network that is not routable from the public Internet. With this arrangement, external Internet clients cannot send network traffic to your nodes directly, which conserves public IP addresses and adds a degree of security. A technique called NAT is employed by a gateway device to transparently substitute the unroutable source IP address with the publicly routable IP address of the gateway.

In some network topographies, your downstream router might perform NAT and your internal systems might then all know how to route internal traffic through the Traffic Manager correctly. However, if this is not the case, you configure the Traffic Manager to perform NAT on forwarded packets to ensure that the responses are routed back through the Traffic Manager gateway.



The Traffic Manager's NAT capability is limited to IPv4 only.

To configure NAT, click the **Manage NAT Settings** link in the "NAT" section of the **System > Networking** page in the Admin UI. Use this page to define rules that govern the behavior of NAT on your Traffic Manager.

In some cases, you might want to use IP Forwarding without configuring NAT: for example, to use the Traffic Manager as a simple IPv4 or IPv6 gateway for your internal network traffic. To do this, tick **Enable IPv4 Forwarding** or **Enable IPv6 Forwarding** as applicable in the "NAT" section of the **System > Networking** page in the Admin UI.



If you enable one or more IP Mapping NAT rules, or if you select any of the Traffic Manager's interfaces to perform NAT, IPv4 forwarding is enabled by default. Therefore, the **Enable IPv4 Forwarding** control is disabled. IPv6 forwarding remains unaffected in these circumstances.

IP Mapping Rules

The Traffic Manager supports three types of outgoing IP NAT rules. Each replaces the source IP address of the traffic that it handles with the primary IP address of the specified traffic IP group.

These rules are applied in the following order of precedence:

| Rule Type | Description |
|--------------------------|--|
| Many to One: Port Locked | NAT is applied to traffic that originates from members of the specified pool, using the specified protocol, and targeting the specified destination port. The protocols valid for this rule type are icmp, sctp, tcp, udp, and udplite. |
| One to One | NAT is applied to traffic that originates from a single specified IP address. If Add Inbound Rule? is ticked, traffic addressed to the primary IP address of the selected Traffic IP Group is forwarded to the specified IP address too, making this rule bidirectional. The source IP address remains unchanged in this case. |

| Rule Type | Description |
|------------------------|---|
| Many to One: All Ports | These rules operate similarly to "Many to One: Port Locked" rules, except that they cover all outgoing traffic for the specified pool, regardless of the target port number. Therefore, you can use these as fallback rules for traffic initiated from a pool to any port numbers not covered by your "Many to One: Port Locked" rules. |

Port Mapping Rules

The Traffic Manager supports the following inbound NAT rules with your virtual servers:

| Rule Type | Description |
|--------------------------------|---|
| Virtual Server Port Forwarding | Incoming traffic targeting a specified port range has its destination port replaced with the port that the selected virtual server listens on. This creates the effect of a virtual server listening on a range of ports instead of one. Port Forwarding does not interact with outbound IP NAT rules. |

Default Rules on Interfaces

Use this section to select an entire Traffic Manager interface on which to perform NAT on the network traffic that is forwarded on behalf of an internal source. Typically, these interfaces have publicly routable IP addresses and are located on the external side of your network (for outgoing traffic).



NAT does not work if the private and public IP addresses are configured on the same NAT-enabled network interface. You must have at least two network interfaces, or more specific rules defined on this page, to create a working NAT configuration.

Enabling this option has the following effect:

- Any traffic that is forwarded by this interface is NAT-enabled: the Traffic Manager replaces the source IP address in the traffic with the IP address of the gateway interface (the Traffic Manager might also replace the source port number with an arbitrary port number).

- From the destination node's perspective, the traffic appears to originate from the Traffic Manager's gateway IP address. The destination node (and all intermediate hops) must know how to route traffic back to that IP address.
- When the destination node replies, the Traffic Manager receives the reply on the interface with NAT enabled. The original source IP address and port is then inserted into the reply and forwarded to the back-end node that originated the connection.

Time and Date Configuration



The settings described in this section will vary slightly for Xen virtual appliance users. Time is synchronized with the host hardware, so the only modifiable setting in this case is the timezone.

It is useful to ensure that the clocks on your Traffic Manager and your back-end nodes are synchronized with each other, so that when you compare log files from each machine, you can determine how events that occurred on each system are related.

If the times are not in sync with each other, it is harder to relate events to each other, such as whether an error logged by the Traffic Manager corresponds to an error recorded by a back-end server.

To manage the time settings on the local Traffic Manager instance, use the **System > Time** page in the Admin UI.



Unlike most other settings in the Admin UI, any settings that you configure on this page only apply to the local Traffic Manager whose Admin UI you are accessing. If you want to inspect or configure the time settings for a different Traffic Manager machine in your cluster, you should use the Admin UI for that machine.

Setting the Time Manually

Use the "Basic Settings" section to view the current system time, date, and timezone, and to set the settings manually if required.

Using an NTP Server

If you configure all your Traffic Manager instances and your back-end servers to use the same NTP server, this ensures that their clocks are set accurately and are closely synchronized with each other.

You can use publicly accessible NTP servers, but due to network latency or outages, these might not be sufficiently reliable. Ivanti recommends you run a local NTP service and synchronize all of your local systems to that server. Your local NTP server could itself synchronize from an NTP server managed by your ISP, or a public NTP server.

If for some reason, the time on your Traffic Manager virtual appliance or cloud instance differs from the correct time by a significant amount, for example, 30 minutes, NTP does not adjust for such a large difference. To correct the time difference in this case, click **System > Time** and then click **Sync Time Now**.

Synchronizing Time from the Traffic Manager

Because it typically spans multiple networks, a Traffic Manager instance can be a suitable, consistent local time source for a variety of networked devices. The Traffic Manager runs a local NTP server that is accessible on all interfaces, so you may wish to configure your other servers to synchronize time from there.

Remote Login to the Traffic Manager

To access the Traffic Manager virtual appliance or cloud instance command line, use SSH. Use the credentials of a user in the "admin" group, or any other group with "Appliance Console" permissions enabled. For more information, see [Permission Groups](#).

Users who login with appropriate credentials have root access to the Traffic Manager instance, and the home directory is set to /root.

To configure password-less logins using SSH public/private key identification, use the SSH configuration directory on the Traffic Manager: /root/.ssh. To restrict SSH access to password-less logins, use the settings in **System > Security > SSH Server** in the Admin UI.

Entering Custom Kernel Parameters

Sysctl is an interface used to add custom appliance kernel parameters in real time, while the system is running. You can add and modify these parameters through the **System > Sysctl** page of the appliance Admin UI.

ATTENTION

This interface is provided for advanced use only. Attempting to change these values could result in unpredictable and unsupported system performance. Ivanti recommends modifying these settings only if you are absolutely sure of the results.

Some kernel parameters are controlled by the Traffic Manager and are generated from other configuration settings that you have applied elsewhere. If you attempt to modify one of these parameters, the Traffic Manager responds with an error message and your change is not applied.

Adding or Modifying a Parameter

To add a new custom kernel parameter, enter the parameter name into the **Key** field and its corresponding value(s) into the **Value** field. For multiple values, separate each with a single space. Ivanti recommends adding to the optional **Description** field a description of your parameter for future reference and problem. Click **Submit Entry** to add your parameter to the appliance.

To modify the value of an existing parameter, enter it again with the new value. All changes are reflected in the **Existing Entries** table.

ATTENTION

All new and modified parameters take effect immediately.

Existing Entries

To view the description for an existing parameter, place the mouse pointer over the **Info** tag to display it. If no description was entered, the **Info** tag is not present.

To delete custom parameters, check the box next to each one you want to remove and click **Delete selected entries**. All selected parameters are immediately removed; however, you must reboot your server to complete the process. Any default values that were previously overridden are restored.

The Traffic Manager checks the validity of the parameters that you enter. Any observable errors are displayed on this page, in the event log, and on the **Diagnose** page.

Kernel Page Table Isolation

By default, Traffic Manager appliance variants are protected against the “Meltdown” attack, CVE-2017-5754, by the Kernel Page Table Isolation (KPTI) feature. KPTI provides protection to prevent unprivileged software from being potentially able to read arbitrary memory from the kernel; however, this protection incurs a general system performance penalty.

To avoid introducing a potential security risk to your Traffic Manager infrastructure, Ivanti strongly recommends that you leave KPTI enabled. However, if you are running only trusted software and the trade-off between performance at the cost of *defense in depth* is acceptable, disable KPTI on your appliance.

To disable KPTI, click **System > Traffic Managers**, unfold "Advanced Settings", and set **appliance!disable_kpti** to "Yes". Click **Update** to apply your change.

System Security

This chapter covers important aspects of running your Traffic Manager software in a secure environment. The points in this chapter that consider operating system configuration apply only to the Traffic Manager software variant, and not to appliance or cloud variants.

Firewall and Operating System Settings

The Traffic Manager is not a network-level firewall and it is highly recommended that any Traffic Manager system is placed behind a firewall of your choosing. There are extra measures that can be taken to reduce potential security problems related to your choice of operating system, and UNIX security in general. These are discussed briefly below.

ATTENTION

The notes that follow are brief and deal specifically with the Traffic Manager product line. Customers are advised to take extra care over all security considerations related to Internet service providing, and to seek specialized advice if required.

Firewalling Techniques

The Traffic Manager must be able to respond to requests, and certain protocols (such as FTP) may need to open additional connections with clients. Stateful firewalls can be configured to allow outgoing connections to be established from the Traffic Manager on any port, and for subsequent responses from clients to be allowed back to the server.

The recommended firewall configuration for the Traffic Manager is therefore a stateful firewall that denies all inbound traffic by default, allowing named ports on the Traffic Manager to be contacted and any responses to the Traffic Manager to be allowed through the firewall.

Default Ports Used by the Traffic Manager

The Traffic Manager requires some ports and protocols in addition to those used by the virtual servers configured. These are:

- **The Admin Server port (HTTPS):** By default, this is port 9090 (TCP and UDP). Use this port, together with the host name or IP address, to browse to the Admin UI. This port must be open to any device from which you want to access the Admin UI, including all other Traffic Managers in your cluster. This port is additionally used by the Traffic Manager's SOAP-based Control API and Command-line Interface (CLI).

For Traffic Manager appliance/virtual appliance/cloud instance variants, the current value of the Admin Server port is displayed on the console. For software variants, read the configuration file `ZEUSHOME/admin/website`. The absence of an entry in this file means that the Admin Server port is the default 9090.

- **The control port:** By default, this is TCP port 9080. The Traffic Manager uses this port for the control protocol to communicate changes in configuration data between Traffic Managers. This port does not need to be exposed outside the cluster.

To learn the current value of the control port, read the configuration file `ZEUSHOME/zxtm/global.cfg`. The absence of an entry in this file means that the control port is the default 9080.

- **The REST API port:** By default, this is TCP port 9070. The REST API is an alternative programmatic method of configuring the Traffic Manager. For more information, see the *Pulse Secure Virtual Traffic Manager: REST API Guide* available from the Ivanti Web site, at www.ivanti.com.

To learn the current value of the REST API port, click **System > Security > REST API** in the Admin UI and observe the value set in **rest!port**.

During initial configuration, if the Traffic Manager determines that any of the default ports are unavailable, the affected port number is incremented by 1 until the Traffic Manager detects a free port. Thus, in this scenario you might find that your Admin Server port is set to 9091, 9092, or higher. This is equivalently true for the Control port (8081 or higher) or the REST API port (9071 or higher).

ATTENTION

All references to port values shown throughout this guide and all other Traffic Manager user documentation should be read to mean *the default value shown here or whatever value has been set/chosen in its place*.

The Admin Server and REST API ports can be user-redefined as required on the **System > Security** page of the Traffic Manager Admin UI. You should then update your firewall rules accordingly.

The Traffic Manager also uses broadcasts to identify other Traffic Managers. These broadcasts are sent to the multicast address, 239.100.1.1 on port 9090 (or alternative). All Traffic Manager cluster members listen on this address. To modify the broadcast IP address and port, use the settings in **System > Fault Tolerance**.

If you have configured each Traffic Manager in your cluster to use a dedicated Management Network as described in [Dedicated Management Network](#), this management traffic will be restricted to that network alone. It should not be possible to connect to any of the Traffic Manager management ports from another network. Nevertheless, you should still firewall these ports off from untrusted sources, for example, in the event that a configuration error relaxes the Traffic Manager's management restrictions, or the management network is accidentally exposed.

Traffic Manager virtual appliances and cloud instances run a local NTP service that listens for NTP (time) requests on all interfaces (see [Synchronizing Time from the Traffic Manager](#)). The NTP services runs on port 123 (UDP and TCP). It is safe to firewall these ports off if you do not wish to use the Traffic Manager as a local time source.

ATTENTION

One of the tests the Traffic Manager uses to detect network availability is ping. The Traffic Manager may not function correctly if your firewall or local TCP/IP tunings disable or rate-limit ICMP packets to the default gateway, the back-end nodes and the other Traffic Managers in the cluster.

Network Design

The Traffic Manager is a proxy with advanced traffic management capabilities. This means that the Traffic Manager is normally placed between two networks, relaying requests from a public network to a private network. Each Traffic Manager must be able to contact machines on both the traffic and back-end networks.

For example, the back-end pools may be on an RFC1597 private network, with IP addresses in any of these groups:

```
10.0.0.0/8
172.16.0.0/12
192.168.0.0/16
```

These networks are not routable on the Internet. They offer both convenience in terms of allocating internal network space, and security, since a correctly configured external router will not accept packets for these networks.

It is therefore most secure for the Traffic Managers to have traffic IP addresses (traffic IP groups) that are connected to the Internet, and for all back-end pools to use RFC1597 network addresses on a separate physical network (or correctly configured VLAN). This then prevents back-end servers from being reached directly from the Internet, and allows the Traffic Manager to manage all inbound connections securely and efficiently.

Furthermore, you can choose to use a separate RFC1597 private network for internal management traffic, including access to the Traffic Manager Admin UI. For more details, see [Dedicated Management Network](#).

UNIX User Permissions

The Traffic Manager software must be started as root. This allows the "zeus.zxtm" process to bind to privileged ports (those below 1024). For example, port 80 (HTTP) is a privileged port. The Traffic Manager also uses superuser privileges to provide fault tolerance; these privileges are needed to raise and lower Ethernet interfaces.

The Traffic Manager processes that manage incoming traffic (in other words, untrusted input) relinquish superuser privileges after they have started. This part of the software runs with the UNIX user and group specified during installation. The Traffic Manager Admin UI service (zeus.admin) does use superuser privileges to manage configuration that is owned by the root user.

For details about the installation process, see the Pulse Secure Virtual Traffic Manager: Installation and Getting Started Guide applicable to your product variant. If you are uncertain of the permissions of the Traffic Manager process, check which user owns the zeus.zxtm processes using the command "ps", or by inspecting \$ZEUSHOME/zxtm/global.cfg. The user is typically nobody, and the group nobody or nogroup.

To change the permissions, Ivanti recommends running the Traffic Manager "configure" script (ZEUSHOME/zxtm/configure) as the system superuser. For more details, see the Pulse Secure Virtual Traffic Manager: Installation and Getting Started Guide applicable to your product variant.

File System Security

All files within ZEUSHOME are configured during installation, and subsequent alterations are made by the Traffic Manager Admin UI. All files within ZEUSHOME are therefore owned by the superuser. Certain files have world-readable permissions flags, in order to allow the zeus.zxtm processes running with unprivileged permissions to read the Traffic Manager configuration files.

If required, the Traffic Manager can be run within a “chroot” jail, effectively preventing all access to the file system other than ZEUSHOME itself. You must provide the required system libraries, some device entries in /dev and some other system-specific configuration information. For further details, see your system documentation.



Syslog logging is based on UNIX sockets and can still write files outside ZEUSHOME.

Operating System Settings

For best security, Traffic Managers should not be used for running applications other than the Traffic Manager, especially applications that provide network services. When a new Traffic Manager is commissioned, pre-installation checks should include removing or disabling UNIX services which will not be used. For example, services such as “lpd” (the UNIX print server) and the RPC Portmapper are often started by default, and are not necessary for the Traffic Manager to function. By uninstalling these services completely, you can dramatically reduce the exposed interfaces that provide a means of accessing your Traffic Manager servers.

Some services might still be required (for example, Syslog and secure shell). Where practical, these services should be bound only to the private network interface or to the loopback interface if they are not required externally. This helps avoid attracting unnecessary attention to your servers, and should be done even where firewalls are in place.

A good preinstallation starting point is to have only port 22 open on the server, for inbound ssh connections, to the management port only (if configured). Open ports can be checked using the freely available “netstat” and “nmap” tools.

Administration of a UNIX server requires regular operating system maintenance. Security is an ongoing process. In particular, it is best practice to track vendor patches and to upgrade services that remain exposed to the Internet as soon as new versions with security-related problems are identified. This applies not only to the services that the Traffic Manager is managing, but also to tools installed on Traffic Managers, such as SSH servers used for administration. For most operating systems, including Linux, the kernel itself might require upgrades from time to time as security problems are identified and fixed.

Administration System Security

This chapter describes how to control access to the administrative components of the Traffic Manager system – the Web-based Admin UI, the REST API, the Control API (and, by implication, the CLI) and remote access through SSH (virtual appliance/cloud instances only).



Throughout this chapter, the term Administration Server (or Admin Server) is used to represent the service through which all administrative components are controlled or routed.

Basic Administration Server Settings

To manage basic security settings, click **System > Security**. This takes you to the “Administration Security” page where you can configure the SSL certificate, IP-based access controls, and the ports used by the Administration Server.

Changing the Admin Server SSL Certificate

The first option, **SSL Certificate**, allows you to change the SSL certificate used for the Traffic Manager Admin Server Web-based user interface (the Admin UI). You can choose to generate a new, self-signed certificate, or upload new certificate and private key files. Click **Update** to save your changes.



You cannot choose a certificate from the catalog, since the Admin Server is not a public service but a separate, external process in the Traffic Manager framework.

The SHA-1 fingerprint of the SSL certificate is displayed here. This is useful for the following reasons:

- To verify the SSL certificate when connecting with a Web browser for the first time.
- To verify the authenticity of Traffic Manager identities when joining a cluster.

Ivanti recommends making a note of the fingerprint upon setting up a new Traffic Manager for the first time. For software variants, the fingerprint is displayed on the command line after completion of the installation process. For appliances and cloud instances, see the console.

Should you need to view the fingerprint again, display it from the command line using the following command:

```
$ZEUSHOME/admin/bin/cert -f fingerprint -in $ZEUSHOME/admin/etc/admin.public
```

Restricting Access to the Admin Server

As well as using the optional management network, the Traffic Manager can restrict access to the Admin Server using three techniques:

- By client IP address (xx.xx.xx.xx)
- By client IP and netmask (xx.xx.xx.xx/nn or xx.xx.xx.xx/xx.xx.xx.xx)
- By client DNS name or DNS wildcard (admin.mysite.com or *.mysite.com)

For example, you could specify 10.1.1.1, 10.0.0.0/24 or *.mysite.com.

The Traffic Manager must perform DNS lookups if you use DNS rules. You must ensure that the necessary DNS settings have been made to allow these lookups to take place.

After you have clicked **Update**, the Traffic Manager checks all connections to the Admin Server before allowing access to the Admin UI login page.

ATTENTION

In order for these restrictions to be effective, external firewalls and services must be trusted. IP addresses can be spoofed, and if your DNS service is subverted or hacked then relying on DNS tests may be ineffective.

Changing Admin Server Ports

Each Traffic Manager runs its own Admin Server on the default port 9090. During initial configuration, if the Traffic Manager determines that the default port is unavailable, the port number is incremented by 1 until the Traffic Manager detects a free port. Thus, in this scenario you might find that your Admin Server port is set to 9091, 9092, or higher.

To change this port manually, update the **adminport** setting in "Management IP Address and Admin Server Port". Changes take place immediately when you click **Update**. If you change this port, the Traffic Manager redirects you automatically to the new URL.

Changing the Admin Server port affects any applications that use the Control API, and the connections made by the CLI.

The REST API uses an alternative port (typically 9070), configurable from the "REST API" section.

For more information on the Traffic Manager's network port requirements, see [Default Ports Used by the Traffic Manager](#).

You can specify a dedicated management port (network interface) at installation time. This value cannot be changed from the Admin UI. To change this value, or to disable the management port entirely, re-run the initial configuration procedure used at installation time. For more details, see the Pulse Secure Virtual Traffic Manager: Installation and Getting Started Guide applicable to your product variant.

Traffic Manager SSH Server Security



This section is not applicable to Traffic Manager software variants.

Traffic Manager virtual appliances and cloud instances provides command line access through a standard SSH server. This is reserved primarily for log retrieval and certain system maintenance operations and is not necessary for normal administrative functions.

To modify the Traffic Manager SSH server security settings, use the “SSH Server” section.

Restricting SSH access might form part of an organizational security policy. In this case, enable or disable SSH access for all users by setting **appliance!ssh!enabled** to “Yes” or “No” accordingly. Where access is enabled, set the preferred port (usually 22) in **appliance!ssh!port**. You can also restrict SSH access to use key-based authentication by setting **appliance!ssh!passwordallowed** to “No”, and installing authorized keys in `/root/.ssh`.

Traffic Manager virtual appliances and cloud instances include an SSH Intrusion Prevention tool to help prevent brute-force SSH attacks. This blocks remote hosts that have made multiple failed connection attempts within a set time period. Use the following settings to configure the behavior of the SSH Intrusion Prevention tool:

| Setting | Description |
|-----------------|--|
| Enabled | Whether SSH Intrusion Prevention is enabled or disabled. |
| Whitelist hosts | A space-separated list of hosts that the SSH Intrusion Prevention tool does not ban (unless the host also appears in the blacklist). Use IP addresses, DNS hostnames, or IP address ranges described by a subnet mask. |
| Time | The length of time, in seconds, a host is banned for. |
| Retry limit | The number of failed connection attempts a host can make to the Traffic Manager before being banned. |

| Setting | Description |
|-----------------|---|
| | <p>Connection attempts made while a host is banned do not count toward the next ban, unless the time hosts are banned for ("Time") is less than the monitored time span ("Time span"). If this is the case, when the host is unbanned it might still have failed attempts recorded from before the ban started that are within the current monitoring window.</p> <p>Attempted connections while banned are immediately dropped, without an authentication challenge.</p> |
| Time span | The time window, in seconds, the SSH Intrusion Prevention tool monitors for failed connection attempts. |
| Blacklist hosts | <p>A space-separated list of IP addresses or DNS hostnames that the SSH Intrusion Prevention tool must never permit access to this Traffic Manager through SSH. Ivanti recommends you ensure that IP addresses and hostnames in the whitelist do not also appear in the blacklist (although the blacklist takes priority).</p> <p>Unlike the whitelist, you cannot blacklist an IP range described by a subnet mask.</p> |

The Traffic Manager displays currently banned hosts, including blacklisted hosts, under "Banned Hosts".

To download log files containing records of the IP addresses banned and unbanned, the times the SSH Intrusion Prevention tool is started or stopped, and any configuration changes, click **Download Log**.

Cluster Communication

Communication between cluster members is handled through secure communications designed to withstand man-in-the-middle and other types of attacks or interventions. The Traffic Manager provides secure public/private key cryptography using SSL to ensure that your cluster members, regardless of their location in the world, remain able to communicate securely and authentically.

The "Cluster Communication" section allows you to place restrictions on the inter-cluster communications in order to provide the precise level of security for your network setup.

The host IP addresses that can contact the internal administration port on each Traffic Manager can be specified by the setting **controlallow**. Specify a list containing IP addresses, CIDR IP subnets, and "localhost", or set to "all" to allow any host to connect.

In the case of clusters that span beyond a single trusted network, it is not always possible to know if a cluster member outside this trusted network has been compromised. In order to prevent other Traffic Managers from becoming compromised, a system administrator can mark certain cluster members as being less secure than others. In other words, if a cluster member is exposed to a higher risk of compromise, you can mark it as "untrusted". An untrusted Traffic Manager can still receive configuration updates, and still broadcasts state and statistical data, but effectively becomes unable to replicate configuration updates out to the other cluster members.

To enable this functionality, each Traffic Manager in the cluster has a **control!canupdate** flag. This can either be enabled for trusted Traffic Managers, or disabled for untrusted Traffic Managers. You must have more than one Traffic Manager in your cluster to use this setting.

 The Admin UI and Control API on untrusted Traffic Managers is disabled for security purposes. If you need to modify machine-specific settings (for example, Networking, Time/Date, or SNMP settings) first enable **control!canupdate**. Depending on your network security requirements, it might also be necessary to temporarily remove that Traffic Manager from the cluster in order to make the change.

A default setting **control!canupdate!default** is provided for new Traffic Managers to inherit when they join the cluster. You might want to modify this to "No" prior to joining a new Traffic Manager from a less trusted location (such as in cloud environments).

ATTENTION

As the Admin UI is disabled on untrusted Traffic Managers, you cannot log on to or make changes to those cluster members. Should you run into a situation where your trusted cluster members become uncontactable for some reason, there exists the risk that you may not be able to administer your entire cluster. In addition, you will be unable to join new Traffic Managers in order to regain control of the cluster. In order to circumvent this risk, it is strongly advised that you maintain at least one redundant trusted Traffic Manager in your cluster at all times. Contact your support provider if you require further assistance.

SSL Settings for Admin Server and Internal Connections

These settings control advanced SSL options for connections to and from the Admin Server, and for secure connections internal to the Traffic Manager. The default settings offer a broad level of security and compatibility suitable for most installations.

Consult your system administrator or support provider should you need to enable compatibility with a specific protocol or connection setting. Ivanti recommends taking care when switching between SSL or TLS versions (or cipher suites) due to the potential effect on intra-cluster communication. For example, to switch from TLS 1.1 to TLS 1.2, enable **admin!support_tls1_2** and allow your modified configuration to replicate across the entire cluster before disabling **admin!support_tls1_1**. During this transition, observe the Traffic Manager event log for any persistent warnings or errors that might indicate an incompatibility or communication failure.

For changes to take effect, you must restart the Admin Server. This happens automatically for changes made through the Admin Server itself, but not for changes made through other interfaces such as the REST or SOAP APIs. In these cases, restart the Admin Server manually through the **System > Traffic Managers** page.



If you are using the Traffic Manager REST API and you modify the setting **admin!support_tls1_2**, you must disable and then reenable the REST API before you can continue to use it with your changed configuration. For information on restarting the REST API, see [Access to the REST API](#).

HTTP Strict Transport Security (HSTS) Settings for the Admin Server

These settings control the HSTS headers added to the Admin Server HTTP pages. HSTS is a web security policy mechanism (defined in RFC 6797) that helps to protect the Admin Server against man-in-the-middle attacks such as protocol downgrade attacks and cookie hijacking. When enabled, HSTS headers declare that web browsers (or other user agents) should only interact with the Admin Server using HTTPS connections. In other words, using SSL or TLS.

HSTS protection applies only after a user has visited the site at least once, and works by ensuring that a user entering or selecting a URL to the site that specifies HTTP automatically upgrades to HTTPS, without making an HTTP request. This prevents the HTTP man-in-the-middle attack from occurring.

The HSTS policy is communicated by the Admin Server to the user agent through an HTTPS response header field named "Strict-Transport-Security". The Admin Server also configures a "max-age" key to specify how long the user-agent should continue to automatically upgrade to HTTPS.

The Traffic Manager includes the following settings, used to control HSTS policy behavior, from **System > Security > HTTP Strict Transport Security (HSTS) Settings for Admin Server**.

- **admin!hsts_enable**: Whether or not HSTS support is enabled for the Admin Server (Default: "No").
- **admin!hsts_max_age**: The maximum age, in seconds, for which the HSTS header applies (Default: "31536000", in other words 365 days)



For these settings to take effect, the Admin Server must be restarted. A restart is triggered automatically when a change is made from the Admin Server itself, but a restart must be activated manually for changes made through other interfaces, for example REST or SOAP.

When using HSTS, consider the following points:

1. HSTS can be enabled only when a non-self-signed SSL certificate has been configured for use by the Admin Server.
2. HSTS settings are not replicated around the cluster and must be enabled on each cluster member after installing a non-self-signed Admin Server SSL certificate.

Managing Administration Certificate Authorities

The Traffic Manager authenticates any SSL-enabled LDAP server that it connects to while performing user authentication through configured Certificate Authorities. Make sure you configure the Traffic Manager with the public certificates from the Certificate Authority (CA) that has issued the LDAP server's certificate.

To manage your CA certificates, click **Catalogs > SSL > Administration Certificate Authorities and Certificate Revocation Lists Catalog**.

To import a new CA file into the Traffic Manager, click **Import certificate or CRL**, and use one of the following methods:

- Click **Choose File** to upload a certificate file from your local workstation to the Traffic Manager.
- Type an HTTP URL or an HTTPS URL into the **File URL** box for the Traffic Manager to download directly.
- Type or copy the contents of a file into the **File Contents** box (PEM-encoded).

Click **Import File** to complete the process. The Traffic Manager imports the CA file and propagates the new information to all Traffic Managers in the cluster.

Access to the REST API

The "REST API" section contains a number of settings applicable to the Traffic Manager REST API service. The service is enabled by default.

To disable the REST API service, set **rest!enabled** to "No". To enable the REST API service, set **rest!enabled** to "Yes".

To set the TCP port that the service listens on, use **rest!port**. The default is 9070, although any unreserved port can be used provided it does not conflict with other services already running on the Traffic Manager system.

Click **Update** to save any changes.

For information on the remainder of the settings on this page, see the *Pulse Secure Virtual Traffic Manager: REST API Guide*, available from the Ivanti Web site (www.ivanti.com). For more information on the Traffic Manager's network port requirements, see [Default Ports Used by the Traffic Manager](#).

User Management

The Admin UI, Control API, REST API, and CLI each require a username and password to authenticate each connection. This login authenticates the user and, by way of Permissions Groups, defines the authorization the user has to read, write and otherwise manage configuration and system operation.

In order to configure users and groups, click **System > Users**.

User Authentication

The Traffic Manager verifies a user's credentials (username and password) against two authentication sources:

- **Local Users:** Credentials are stored locally in the Traffic Manager configuration.

The Traffic Manager includes a factory-default local user "admin" that has full administrative permissions (in other words, is a member of the "admin" Permissions Group). In basic administration environments, users log in with this account to perform configuration tasks.

You cannot rename user accounts, but you can remove them. If you want to remove the "admin" user, you must first ensure that another user account with equivalent admin permissions exists so that you can log in and manage your cluster.

- **Remotely authenticated users:** Credentials are authenticated against externally-located systems based on RADIUS, LDAP or TACACS+ services.

Authenticators define how the Traffic Manager verifies usernames and passwords against the database and how it determines the Permissions Group that the user is a member of. To configure authenticators, use the "Authenticators" section in **System > Users**.

When a user attempts to log in, the Traffic Manager first compares the credentials to the list of Local Users and determines the Permissions Group that the user is a member of. If a match is not found, the Traffic Manager then tries each Authenticator in turn until the user is authenticated and a Permissions Group is determined.

Local Users

To add a new local user, provide a username and password in the "Create New User" box, and select a group from the drop-down box. This specifies which Permission Group this user belongs to.

To modify the password, Permission Group or UI Preferences for an existing user, click the username on the "Local Users" page.

UI Preferences for Local Users

Local Users have access to several preference settings that control aspects of the Admin UI:

| Setting | Description |
|----------------------|---|
| use_applet | Enables or disables the status applet that is displayed in every UI page. You can disable this applet to reduce bandwidth, or to reduce HTTP requests when using a tool such as LiveHTTPHeaders or FireBug to monitor HTTP traffic to the Traffic Manager IP address. |
| appletwidth | Changes the width of the applet, allowing it to display more (or fewer) bars in the chart that graphs traffic per virtual server. |
| trafficscript_editor | Enables or disables the advanced TrafficScript editor, replacing it with a simple textbox when disabled. |

To delete a user, click **Delete User**.

Password Policy

The Password Policy page allows you to configure the password policies applied when local users are created or when they change their passwords. Restrictions on the length of passwords, what character types they must contain, how often they can be changed and how often they must be renewed can be configured here.

You can specify the following security settings:

- **No restrictions:** All passwords are allowed, no restrictions are applied.
- **Default restrictions:** Standard password security is applied to new passwords, specifically:
 - Passwords must be at least 8 characters in length.
 - Passwords must contain at least two alphabetic characters.
 - Passwords must contain at least one uppercase character.
 - Passwords must contain at least one numeric character.
 - Passwords must contain at least one special, non-alphanumeric character.
 - Passwords must not contain repeated consecutive characters, such as 'aaaaa'.
- **Custom restrictions:** The minimum length of passwords and the types of characters they can contain can be specified manually.

In addition, the Traffic Manager will maintain a history of passwords used by each user. The setting **password_reuse_after** allows you to specify after how many changes a user can re-use a previous password. This helps to ensure that your users do not simply reset to the same password each time a change is made or required. A value of 0 means a user can re-use any passwords they have previously used.

The setting **password_changes_per_day** specifies how many times a user is allowed to change their password in a 24-hour period. If it is set to 0 then there is no limit to the number of times a password can be changed in one day.

Authenticators

If a user cannot be found in the list of Local Users, the Administration Server will test the credentials against any Authenticators that have been fully configured (and are not disabled). An Authenticator queries an external database, and returns the name of the Permissions Group for users who have valid credentials. Generally the name of the Permissions Group is stored in a field in the remote authentication database, and users who do not have a valid Permissions Group are not allowed access to the Administration Server.

The Administration Server supports LDAP, RADIUS and TACACS+ authentication databases.

Creating an Authenticator

To add a new authenticator, click **System > Users > Authenticators**. Provide a name and select the appropriate authenticator type, then click **Create Authenticator**. This creates an unconfigured authenticator; you must provide the appropriate configuration settings for the type you have chosen. After the authenticator is configured and you have tested it, enable the authenticator by setting **auth!enabled** to "Yes".

The Traffic Manager does not use an Authenticator until it has been enabled in this way. If several Authenticators are enabled, the Traffic Manager tries each authenticator (in lexicographic order) until one successfully retrieves a Permissions Group.

LDAP Authenticators

LDAP authenticators have the following configurable settings:

| Setting | Description |
|-------------|--|
| ldap!server | The IP address or hostname of the LDAP server. |
| ldap!port | The port used to connect to the LDAP server. |
| ldap!ssl | Whether the connection to the LDAP server is protected by SSL, and if so, whether that protection incorporates the STARTTLS or LDAPS method. |

| Setting | Description |
|------------------------------------|---|
| | If you enable SSL for the connection, you must also configure a Certificate Authority for the LDAP server's certificate in the Administration Certificate Authorities and Certificate Revocation Lists Catalog . For more information, see Managing Administration Certificate Authorities . |
| ldap!timeout | The timeout period (in seconds) for a connection to the LDAP server. |
| ldap!basedn | The base DN (Distinguished Name) for directory searches. |
| ldap!filter | A filter that uniquely identifies a user located under the base DN. The string "%u" will be substituted with the username. Examples: "sAMAccountName=%u" (Active Directory) or "uid=%u" (Unix LDAP). |
| ldap!dnmethod | The bind DN for a user can be constructed from a known string ("Construct") or can be searched for in the directory ("Search" - necessary if you have users under different directory paths). |
| ldap!binddn | The template to construct the binddn from the username. The string "%u" is replaced by the username. Examples: "%u@mycompany.local" or "cn=%u, dn=mycompany, dn=local". This setting is applicable only if ldap!dnmethod is "Construct". |
| ldap!searchdn / ldap!searchpass | The bind DN and password to use when searching the directory for a user's bind DN. Leave this setting blank if it is possible to perform the bind DN search using an anonymous bind. These settings are applicable only if ldap!dnmethod is "Search". |
| ldap!groupfilter | If the user record returned by ldap!filter above does not contain the required group information, use this setting to specify an alternative group search filter. This is typically required if you have UNIX/POSIX-style user records. If multiple records are returned, the list of group names are extracted from all records. The string %u is replaced by the username. Example: (&(memberUid=%u)(objectClass=posixGroup)) |

| Setting | Description |
|--------------------|--|
| ldap!groupattr | The LDAP attribute that gives a user's group. If multiple values are returned by the LDAP server the first valid one is used. |
| ldap!groupfield | The sub-field of the group attribute (ldap!groupattr) that specifies a user's group. For example, if ldap!groupattr is set to "memberOf", which returns a value such as "CN=mygroup, OU=groups, OU=users, DC=mycompany, DC=local", set ldap!groupfield to "CN" (the first matching field is used). |
| ldap!fallbackgroup | If ldap!groupattr is not defined above, or is not set for the user, the group named here is used. If not specified, users with no attribute matching ldap!groupattr are denied access. |

RADIUS Authenticators

RADIUS authenticators have the following configurable settings:

| Setting | Description |
|----------------------|--|
| radius!server | The IP address or hostname of the RADIUS server. |
| radius!port | The port used to connect to the RADIUS server. |
| radius!timeout | The timeout period (in seconds) for a connection to the RADIUS server. |
| radius!secret | The secret key shared with the RADIUS server. |
| radius!groupvendor | The RADIUS identifier for the vendor of the RADIUS attribute that specifies an account's group. Leave blank if using a standard attribute * such as Filter-Id. |
| radius!groupattr | The RADIUS identifier for the attribute that specifies an account's group. May be left blank if radius!fallbackgroup is specified. |
| radius!fallbackgroup | If no group is found using the vendor and group identifiers, or the group found is not valid, the group specified here is used. |

| Setting | Description |
|-----------------------|---|
| radius!nas-ip-address | This value is sent to the RADIUS server, if left blank the address of the interfaced used to connect to the server is used. |
| radius!nas-identifier | This value is sent to the RADIUS server. |

TACACS+ Authenticators

TACACS+ authenticators have the following configurable settings:

| Setting | Description |
|--------------------------|---|
| tacacsplus!server | The IP or hostname of the TACACS+ server. |
| tacacsplus!port | The port to connect to the TACACS+ server on. |
| tacacsplus!timeout | The timeout period (in seconds) for a connection to the TACACS+ server. |
| tacacsplus!secret | The secret key shared with the TACACS+ server. |
| tacacsplus!authtype | The authentication type to use. This can be PAP or ACSII. |
| tacacsplus!groupsvc | The TACACS+ "service" that provides each user's group field. |
| tacacsplus!groupfield | The TACACS+ "service" field that provides each user's group. |
| tacacsplus!fallbackgroup | If tacacsplus!groupsvc is not defined, or no group value is provided for the user by the TACACS+ server, the group specified here is used. If this is not specified, users with no TACACS+ defined group is denied access. |

Testing an Authenticator

To test an authenticator, use the "Test Configuration" section on the **System > Users > Authenticators > Edit** page. Specify the username and password you want to test; the Authenticator will run and, if successful, return the name of the Permissions Group that the user is a member of. The Authenticator will also provide detailed debugging information to help you fine-tune or correct your configuration if necessary.

Worked Example: Authenticating Against Active Directory

You can authenticate users against an Active Directory database using the LDAP Authenticator. Use the following settings for your authenticator:

| Setting | Value |
|-----------------|--|
| ldap!server | dir.company.com |
| ldap!port | 389 |
| ldap!ssl | STARTTLS |
| ldap!basedn | OU=Company Users, DC=company, DC=local |
| ldap!filter | sAMAccountName=%u |
| ldap!dnmethod | Construct |
| ldap!binddn | %u@company.local |
| ldap!groupattr | memberOf |
| ldap!groupfield | CN |

Test this Authenticator with a username and password. The following typical output is produced:

```

Authenticating as username@company.local
Authenticated
Executing LDAP search, parameters:
    filter: sAMAccountName=username
    basedn: OU=Company Users,DC=company,DC=local
dir.company.com(fd6e:9138:1b6c:6401::a3e:9850:389): Connected
Bound as user username@company.local
Found group record, DN: CN=User Name,OU=Company Users,DC=company,DC=local
Found groups: Demo
No ldap!fallbackgroup defined
Groups returned by authenticator: Demo
SUCCEDED, group: Demo

```

Permission Groups

Permission Groups are used to assign access to different parts of the Traffic Manager Admin Server to different users. All local and remote users are members of groups, and these groups define the access users have to the different aspects of the Traffic Manager. By default, Ivanti provides a number of pre-defined groups that you can modify or delete according to your local needs. You can also add any number of new customized groups.

To add a new group, specify a name in the "Group name" box and click **Update**. After the change has been committed, click the new group name.

Each group has a basic "Description" and a "Login Timeout" setting. The description can be used to provide a brief explanation of the purpose of this group, and the login timeout is the period after which inactive Admin Server sessions are terminated. All users that belong to this group inherit this timeout value.

Editing the Permissions of Users in the Group

The Traffic Manager displays a complete list of pages available within the Admin UI, together with the permission settings for each one. All actions are permitted within the "admin" group. A newly created group starts with all permissions set to "None".

Each page can have one of the following permissions set for the group in question:

- **None:** Group members cannot use this feature.
- **Read Only:** Group members can view, but not modify items associated with this page.
- **Full:** Members can view and modify items associated with this page.

Using the **Catalog > SSL Certificates** page as an example, if you set the permissions to "None", members of this group cannot view the "SSL Certificates" catalog page. Use "Read Only" permissions to allow members to view the page but not make changes. Use "Full" permissions to ensure no restrictions apply.



On some pages (such as catalog summary pages) there are no configurable settings. Blocking access to a page does not restrict access to those hierarchically below it, nor the settings on them.

ATTENTION

Groups with access to the **System > Users** pages can edit their own account details. Ivanti recommends taking care when setting which users have these privileges.

Advice Concerning External Program Permissions

Action programs and monitor programs run with the same UNIX user permissions as the Traffic Manager itself, thus caution is recommended when allowing permission to the pages that control these items.

The specific permissions affected are:

- Extra Files > Action Programs
- Extra Files > Monitor Programs
- Monitors > Edit
- Alerting > Actions > Edit

Login Timeout

The login timeout is measured in minutes, and is the period of inactivity allowed before the Traffic Manager ends your session with the Admin UI. Your session is also closed automatically if you close your browser window, or if you log out manually by clicking **Logout**.

The login timeout is a property of a Permissions Group. Click **System > Users > Permissions Groups** and click the name of the Permission Group you want to modify. Set the new timeout value in "Inactivity Timeout" and click **Update**.

Suspended Users

This page allows you to re-enable one or more users that have been suspended. Users might have been suspended due to exceeding the maximum allowed login attempts, or for some other administrative reason.

Check the box next to each user you want to re-enable, and click **Enable Selected Users**.

Note that individual users can also be re-enabled from the **System > Users > Local Users > Edit** page, by setting **Status** to "Active".

Login Security and Behavior

Password policy can be defined on the **System > Users > Local Users > Password Policy** page to control and place restrictions on user login passwords (see [Local Users](#)). In addition to this, you can define further login behavior settings to provide a greater degree of control and security awareness for the users of your system. The “Login and Security Settings” section of the **System > Global Settings** page provides a number of configuration settings split broadly into two themes:

UI Screen Banners

Should you need to provide your users with a suitable message or reminder upon using the system, define these here.

| Setting | Description |
|---------------|--|
| login_banner | A banner text message to be displayed to anyone who attempts to log in to the Admin UI or Traffic Manager SSH command line. |
| banner_accept | Whether the user is required to explicitly acknowledge and agree to the login_banner text prior to logging into the Admin UI. A check box is added to the login page for this purpose. |
| uipage_banner | This is a text message that will be displayed at the top and bottom of each page of the Admin UI. |

Login Controls

You can place controls on the number of login attempts available to users, and the consequences of breaching this.

| Setting | Description |
|--------------------|--|
| max_login_attempts | <p>The number of login failures permitted before a user account is suspended. A value of 0 disables this feature. Default: 0.</p> <p>The user account is reactivated after the delay set in max_login_suspension_time; however, it can be reactivated sooner from the System > Users > Local Users > Edit page or the System > Users > Suspended Users page (see Suspended Users).</p> |

| Setting | Description |
|---------------------------|---|
| | Ivanti recommends exercising caution when using a login attempt limit with password based authentication. Always use additional security measures such as a firewall or unique user naming convention to avoid rendering your Traffic Manager potentially inaccessible through a Denial-of-Service attack on your administrative user logins. |
| max_login_external | Specifies whether externally authenticated (LDAP, RADIUS or TACACS+) users should be suspended after max_login_attempts login failures. |
| max_login_suspension_time | The length of time for which a user account is suspended after max_login_attempts login failures. |
| login_delay | The delay after a failed login before another login attempt can be made. Default: 4. |

The Login Information Banner

 Last successful login by admin: 2011-02-24 12:35:03 +0000 from 10.100.1.14 (UI) on coeus.
Failed login attempts since then: 1, last was: 2011-02-24 13:41:31 +0000 from 10.100.1.14 (UI) on coeus.

At the top of the **Home Page**, an information banner describes the previous successful login attempt by the current user on this system. Any previous failed attempts are also shown here, in order that you can identify any unexpected or unauthorized use of your login credentials.

The Event and Audit Logs

The event log contains system and configuration messages, warnings, and errors from all Traffic Managers in your cluster. A truncated version of the event log can be found on the Home page of the Traffic Manager Admin UI. To view the full logs, click **Examine Logs** or **Diagnose > Event Log**.

The audit log monitors recent login attempts, configuration changes (by user and source IP address), and user logouts. It also records changes made using the Control API and REST API. To view the audit log, click **Diagnose > Audit Log** in the Traffic Manager Admin UI.

For virtual appliances and cloud instances, the Traffic Manager controls event log and audit log rotation automatically. Logs are rotated once the maximum file size of 50MB is reached for the current log. As the log is rotated, a new archive file is created for the log entries up to that point, and the current log cleared. Archive files are then compressed with "gzip" and given a filename in the format shown here:

- **For audit logs:** audit-<date>-<sequence>.gz
- **For event logs:** event-<date>-<sequence>.gz

where <sequence> is an incremental number provided for multiple same-day rotations.

For Traffic Manager software variants, you must enact your own rotation policy.

To access archived audit log files, click **Manage archived audit logs** on the **Diagnose > Audit Log** page. To access archived event log files, click **Manage archived event logs** on the **Diagnose > Event Log** page.

For each archived log, you can download or delete the file using the controls provided.



To override the default maximum file size used by the Traffic Manager for audit and event log file rotation, set the system level environment variables `AUDITLOG_ROTATE_THRESHOLD` or `EVENTLOG_ROTATE_THRESHOLD` correspondingly, although certain appliance and cloud variants might have an alternate automatic threshold that is implemented in place of this. For more details, see the *Pulse Secure Virtual Traffic Manager: Installation and Getting Started Guide* applicable to your product variant.

General Security Considerations

Using Regular Expressions

Regular expressions provide the capability to search, match, and manipulate data. What is achievable with the scope they provide is hard to quantify or analyze. As such, the effective threat surface area they expose is too large to enumerate completely. This section serves to provide information and context around the security implications when using regular expressions.

Regular expressions might be configured for particular features of the Traffic Manager. They might also be used in arbitrary ways through functions available to TrafficScript rules.

Two vectors are potentially available to a highly-skilled attacker:

1. **Denial of Service:** Also known as "ReDoS". It is possible to create regular expressions, "Evil Regexes", that when executed can consume a considerable amount of either memory or CPU.
2. **Data Exfiltration:** Following on from the discovery of CPU-cache-based side-channel attacks (for example, "Spectre"), a regular expression could be used to generate a *widget*, through the just-in-time code generator, that could be used to exfiltrate data from your Traffic Manager processes.

Ivanti must emphasize that such attacks are not trivial to construct or execute. However, this section aims to provide context for proactive mitigation and policy decisions. The following suggestions provide ways to address such threats:

1. Sanitize data used in the construction of a regular expression. In the simplest case, use \Q and \E quoting to avoid considering the provided data as part of the regex syntax.
2. Use the group permissions capability in the Traffic Manager to assign administrators with only those permissions that they require, following the principle of least privilege.

The Traffic Manager Control API

This chapter provides a brief overview of the Traffic Manager SOAP-based Control API. For further information, please refer to the *Pulse Secure Virtual Traffic Manager: Control API Guide* included with your distribution.



For information regarding the Traffic Manager REST API, see [inst](#)

Introducing the Traffic Manager Control API



The Traffic Manager Control API is not available on all Traffic Manager product variants. Refer to your product specifications for full details.

The Traffic Manager Control API is a standards-conformant SOAP API that can be used to remotely administer and configure a Traffic Manager cluster. The Control API provides an alternative to the Web-based Admin UI and is suitable if you want to configure the Traffic Manager from another application.

For example, if an Intrusion Detection System detected a remote attack attempt, it could use the Traffic Manager Control API to configure the Traffic Manager cluster to drop all connections from the suspect IP address.

A provisioning system could detect server overloading by monitoring the response times of the server nodes using the Traffic Manager's Service Level Monitoring capability and the SNMP interface. After it had provisioned additional servers, it could then inform the Traffic Manager by reconfiguring the server pools using the Traffic Manager Control API.

The Traffic Manager Control API can be used by any programming language and application environment that supports SOAP services. Perl, Python, Java, and C# are commonly used.



Control API communication uses the Traffic Manager's Admin Server port (by default, 9090). In some cases, your Admin Server might be running on an alternative port number. In the examples that follow, substitute references to port 9090 as appropriate. For more information on the Traffic Manager's network port requirements, see [Default Ports Used by the Traffic Manager](#).

Example: Listing Running Virtual Servers

Perl with SOAP::Lite

```
#!/usr/bin/perl -w

use SOAP::Lite 0.60;

# This is the url of the Traffic Manager Admin UI
my $admin_server = 'https://username:password@host:9090';

my $conn = SOAP::Lite
    -> uri('http://soap.zeus.com/zxtm/1.0/VirtualServer/')
    -> proxy("$admin_server/soap");

# Get a list of virtual servers
my $res = $conn->getVirtualServerNames();
my @names = @{$res->result};

# Establish which are enabled
$res = $conn->getEnabled( \@names );
my @enabled = @{$res->result};

# Print those which are enabled
for( my $i = 0; $i <= $#names; $i++ ) {
    if( $enabled[$i] ) {
        print "$names[$i]\n";
    }
}
```

Run the example as follows:

```
$ ./listVS.pl
Main website
Mail servers
Test site
```

C Sharp or Mono

```
using System;
using System.Net;
```

```
using System.IO;
using System.Security.Cryptography.X509Certificates;

public class AllowSelfSignedCerts : ICertificatePolicy {
    public bool CheckValidationResult(
        ServicePoint sp, X509Certificate cert,
        WebRequest request, int problem )
    {
        return true;
    }
}

public class listVS {

    public static void Main( string [] args )
    {
        System.Net.ServicePointManager.CertificatePolicy =
            new AllowSelfSignedCerts();

        string url= "https://host:9090/soap";
        string username = "username";
        string password = "password";

        try {
            ZXTM.VirtualServer p = new ZXTM.VirtualServer();
            p.Url = url;
            p.Credentials = new NetworkCredential( username, password );

            string[] names = p.getVirtualServerNames();
            bool[] enabled = p.getEnabled( names );

            for ( int i = 0; i < names.Length; i++ ) {
                if( enabled[i] ) {
                    Console.WriteLine( "{0}", names[i] );
                }
            }
        } catch ( Exception e ) {
            Console.WriteLine( "{0}", e );
        }
    }
}
```

This code works with the .NET 1.1 SDK and with Mono.

Using .Net 1.1, compile and run this example as follows:

```
C:\> wsdl -o:VirtualServer.cs -n:ZXTM VirtualServer.wsdl
C:\> csc /out:listVS.exe VirtualServer.cs listVS.cs
C:\> listVS.exe
Main website
Mail servers
Test site
```

With Mono, compile and run as follows:

```
$ wsdl -o:VirtualServer.cs -n:ZXTM VirtualServer.wsdl
$ msc /out:listVS.exe /r:System.Web.Services \
    VirtualServer.cs listVS.cs
$ listVS.exe
Main website
Mail servers
Test site
```

Further Examples

For further examples using other programming languages, see the *Pulse Secure Virtual Traffic Manager: Control API Guide*.

Command Line Interface

This chapter introduces you to the Traffic Manager's Command Line Interface (CLI).

Introduction

Your Traffic Manager is typically managed using the Web-based Admin UI. For scripting the configuration, or integrating with other systems, the Traffic Manager also provides an industry-standard SOAP API and REST API.

Writing an application to use the SOAP-based Control API or REST API can take time and might not be appropriate for small, simple tasks or one-off configuration. For quick access to the full functionality of your Traffic Manager, consider instead using the CLI.

The CLI functions as an interactive shell, and can also be scripted. The CLI uses the Control API to communicate with the Traffic Manager cluster, and the commands available in the CLI correspond to the methods available in the Control API.

 Control API communication uses the Traffic Manager's Admin Server port (by default, 9090). In some cases, your Admin Server might be running on an alternative port number. In the examples that follow, substitute references to port 9090 as appropriate. For more information on the Traffic Manager's network port requirements, see [Default Ports Used by the Traffic Manager](#).

Accessing the CLI

To start the CLI, use the following program:

```
ZEUSHOME/zxtm/bin/zcli
```

You can connect to the CLI by logging in to a virtual appliance/cloud instance directly using SSH (see [Remote Login to the Traffic Manager](#)) and typing the command `zcli`. Alternatively, you can connect remotely by specifying the user and host as arguments to the `zcli` command:

```
zcli [user@]host:port
```

For example:

```
zcli admin@ztml:9090
```

Usage and options for `zcli` can be listed by specifying `--help` as an argument:

```
zcli --help
```

```
Usage: ./zcli [OPTIONS] [user@][host:port] [script file]
```

Configure the Traffic Manager from a script file or standard input.

```
--user USER      Set the username (default: admin)
--passfile FILE   Read the password from this file
--nossl          Your Traffic Manager does not have SSL enabled admin server
--verbose        Verbose output (for testing)
--continue       When running a script, continue even if an error occurs
--help           Show this help
--version        Show the version of this program
--formatoutput   Use 'human readable' output, even in script mode
--json          Use strict JSON output, even in interactive mode
--timeout SECONDS Set timeout for commands
```

If no host:port is specified, the local Traffic Manager will be used.

Permissions

The CLI must authenticate itself with the Traffic Manager using a username and password with “Control API” permissions (see [Network Design](#)). Any user in the “admin” group has appropriate permissions, and you can add those permissions to other user groups.

By default, the CLI uses the username “admin” to communicate with the Traffic Manager (the --user option can be used to select an alternative username):

```
$ zcli
Please enter your password for user 'admin' on the local Traffic Manager
Connected to 127.0.0.1:9090
admin@127.0.0.1 >
```

After the connection is established, the CLI displays a prompt (showing the username and hostname of the Traffic Manager) and waits for a command to be entered:

```
admin@127.0.0.1 >
```

Commands can be typed in one at a time. A command history is maintained, so pressing the up and down arrow keys will step back through previous commands. Auto-completion is also available for many commands; pressing the tab key will auto-complete any half-typed command or object name. Pressing ‘tab’ twice will list the valid options.

The command help provides a simple overview of the CLI and suggests help topics to find more information on the available commands:

```
Developer mode
admin@10.62.165.97 > help
The Pulse Secure Virtual Traffic Manager command-line interface provides direct
access to all of the Control API calls that control and configure your traffic
manager, together with additional commands to monitor it and its configuration.

Getting started

help overview - brief overview of the command line interface
help syntax   - explain the syntax for entering commands and data (important!)
help output   - explain the output format for commands
help commands - describe all of the commands
help classes  - describe all of the API classes
help <class>  - show the methods for a particular class, e.g. "help Pool"
help <cmd>    - describe a command, e.g. "help Pool.addNodes" or "help show"

info         - show a brief summary of this traffic manager
catalogs     - list all configuration objects in this traffic manager
show        - show specific configuration, e.g. "show Pool"
stats       - show traffic manager statistics/counters, e.g. "stats webcache"

admin@10.62.165.97 > █
```

Commands

To discover the available commands, type `commands` for a detailed list, or use tab-completion (press the keyboard TAB key twice) for a brief list of commands and objects.

Commands fall into three main groups:

1. Control API methods

These are of the form `Class.method [arguments...]`, for example:

```
admin@127.0.0.1 > Pool.getNodes "Web Servers"
[ "92.52.65.222:80", "92.52.65.213:80" ]
```

2. Helper commands

These summarize the Traffic Manager configuration; the main commands are:

- `info`: show a brief summary of this Traffic Manager
- `catalogs`: list all configuration objects in this Traffic Manager
- `show`: show specific configuration. For example, `show Pool`
- `stats`: show Traffic Manager statistics/counters. For example, `stats webcache`

3. CLI help

- help syntax: explain the syntax for entering commands and data
- help output: explain the output format for commands
- help commands: describe all of the commands
- help classes: describe all of the API classes
- help <class>: show the methods for a particular class. For example, help Pool
- help <cmd>: describe a command. For example, help Pool.addNodes or help show

Control API methods

All of the Control API methods are accessible via the CLI. The corresponding command is constructed from the class name and method name as listed in the *Pulse Secure Virtual Traffic Manager: Control API Guide*; refer to this document for details about each command.

For example, to list all of the virtual servers:

```
admin@127.0.0.1 > VirtualServer.getVirtualServerNames
[ Intranet, "Secure Site", webmail ]
```

Understanding Arguments to CLI Commands

Arguments for commands are given as space separated names; commas between arguments are optional. Argument values that contain a space or other special characters that may confuse the syntax should be "quoted". Lists are contained within square brackets ([]).

For example, *Pulse Secure Virtual Traffic Manager: Control API Guide* details the method "getNodes" in the Pool class as follows:

getNodes(names) throws ObjectDoesNotExist

Get the lists of nodes for each of the named pools.

```
String[][] getNodes(
String[] names
)
```

The corresponding CLI command would be Pool.getNodes. The documentation shows that the command takes an array of pool names (String[] names); the command line to call this method on two pools would be:

```
admin@127.0.0.1 > Pool.getNodes [ pool1 pool2 ]
{ pool1: [ "serverA:80", "serverB:80" ],
  pool2: [ "serverC:80", "serverD:80" ] }
```

The output from `Pool.getNodes` is declared as `String[][]`, in other words, an array of arrays. For each pool that was specified, an array of nodes is returned.

For convenience, in its interactive mode, the CLI indexes the output of the command to show the list of nodes prefixed by the pool name that they refer to.

Using a Single Argument

Many commands in the Control API take a list of arguments so that they can operate on more than one object at once. To simplify the use of commands with a single item, the array can be omitted:

```
admin@127.0.0.1 > Pool.getNodes pool1
[ "serverA:80", "serverB:80" ]
```

Using Wildcards

The `*` symbol is a wildcard that can be used to match multiple objects:

```
admin@127.0.0.1 > VirtualServer.getDefaultPool *
{ Intranet: pool1,
  "Secure Site": "Secure pool",
  webmail: "Mail servers" }
```

Partial names can also be wildcarded. For example, to enable keep-alives on all the pools with a name beginning "Pool":

```
admin@127.0.0.1 > Pool.setKeepalive Pool* 1
```

Complex Argument Types

Some commands require more complicated argument structures. For instance, `VirtualServer.addVirtualServer` is defined in *Pulse Secure Virtual Traffic Manager: Control API Guide* as:

```
void addVirtualServer(
    String[] names,
    VirtualServer.BasicInfo[] info )
```

The `BasicInfo` structure is defined as:

```
struct VirtualServer.BasicInfo {
    # The port to listen for incoming connections on.
    Integer port;

    # The protocol that this virtual server handles.
    VirtualServer.Protocol protocol;

    # The default pool that traffic to this virtual server
    # will go to.
    String default_pool;
}
```

Structures are supplied to the CLI by using "{" and "}" curly brackets, identifying each member with key:value pairs. For example,

```
admin@127.0.0.1 > VirtualServer.addVirtualServer Intranet { port: 80, protocol: http,
default_pool: pool1 }
```

To obtain help with the expected arguments for any command, use the help available through the CLI:

```
admin@127.0.0.1 > help VirtualServer.addVirtualServer
```

Custom Configuration Sets

You can store and retrieve arbitrary name:value configuration pairs in the Traffic Manager configuration system using the CLI. This configuration is replicated across your cluster, and is only accessible through the REST API, SOAP API, and CLI.

You can find a full list of commands associated with storing and retrieving custom configuration by typing help Custom at the prompt.

To store a custom configuration, use the Custom.setStringsLists command. The following example sets a name:value pair under the list named "counters":

```
Custom.setStringLists [counters], [ {"name": "Test_Counter", "value" : ["12345",
"67890"]} ]
```

You can add multiple name:value config pairs to the list by appending additional {"name":<name>, "value":<value>} items as desired.

To retrieve the "counters" configuration, use the following command:

```
Custom.getStringLists counters
```

Using this system, you can organize your custom configuration into logical groups, initially by creating a new list, and within this, by each name:value pair. Each value can itself be a single item or a list of items.

Built-in Commands

The CLI includes a number of additional commands that simplify viewing and modifying configuration. Full help and usage instructions can be found using `help <commandname>`.

- `info`: Shows high-level information about this Traffic Manager, similar to the Home Page of the Admin UI. This shows the Traffic Managers in a cluster, the virtual servers and pools configured, traffic IP addresses, any configuration or operational errors, and the most recent entries in the event logs.
- `connect`: Connect to a different Traffic Manager. The CLI can be used to communicate with remote Traffic Managers, including Traffic Managers that are not in the same cluster as the local machine. This command is also useful when writing scripts, as the Traffic Manager hostname, username, and password can all be contained in the script file.
- `errorlog`: Shows the most recent messages in the Traffic Manager event logs.
- `catalogs`: Lists the contents of the configuration catalogs, showing items such as Monitors, TrafficScript rules and Java Extensions.
- `show`: Show the configuration of any configuration object in the Traffic Manager. For example:
 - `show VirtualServer Intranet`: Shows a summary of the virtual server 'Intranet'
 - `show Pool`: Shows a summary of all pools
 - `show VirtualServer customer*`: Shows a summary of the virtual servers customer*

You can also just use `show` with an object name, and it will summarize all objects that match that, for example:

- `show Staging`: Shows a summary of any object called "Staging"
- `show *`: Shows everything (may take some time)

The `show` command can also be used to provide details about all current connections being handled by the Traffic Manager (by using the command `show connections`). The output is based on the connection info displayed on the **Activity > Connections** page of the Admin UI, with the following data items listed where a connection is in progress:

| Data Item | Description |
|-----------|--|
| From | Client IP address and port for connection |
| Via | Local IP address and port the client connected to |
| To | Back-end node used for the connection |
| State | <p>The current connection state; can be one of:</p> <p>C: Connection to client was closed</p> <p>f: Connection finished</p> <p>R: Reading from client</p> <p>W: Writing to client</p> <p>X: Executing rules against client request</p> <p>c: Connecting to a back-end node</p> <p>w: Writing to a back-end node</p> <p>r: Reading from a back-end node</p> <p>C: Closing connection with client</p> <p>K: Holding client connection in keep-alive state.</p> |
| VS | The virtual server handling this connection |
| Rule | The last rule run on the connection |
| Pool | The pool that is used |
| BytesIn | Bytes received from the client |
| BytesOut | Bytes sent to the client |
| Timings | <p>In the format <num1> / <num2> / <num3> where:</p> <p><num1>: Time since the client established this connection</p> <p><num2>: Time since last data sent on that client connection</p> |

| Data Item | Description |
|-----------|--|
| | <num3>: Time since last data sent on the separate back-end connection |
| Retries | The number of times the server had to retry to connect to a back-end node |
| SLM | The Service Level Monitoring class being used |
| VSBW | The bandwidth class the virtual server used |
| PoolBW | The bandwidth class the pool used |
| Code | The response code that was returned by the back-end node, varies depending on protocol |
| Request | Summary of the request made. For HTTP this is the URL requested |



Additional fields may also be shown where extra information is identified as applicable to the connection.

The full list of possible object types that can be specified as an argument to show is:

`action, authenticator, bandwidth, ca, certificate, clientcertificate, connections, event, global, info, java, licensekey, monitor, persistence, pool, protection, rate, rule, slm, trafficip, virtualserver`

- `stats`: Shows counters and statistics for various different objects in the Traffic Manager. For example:
 - `stats VirtualServer Web` - Shows stats for the virtual server "Web"
 - `stats Pool` - Shows stats for all pools
 - `stats *` - Shows stats for everything

You can also just use `stats` with an object name, and it will display stats for all objects that match that name, for example:

- `stats Staging` - Shows stats for any object called "Staging"
- `stats *` - Shows stats for everything (may take some time)

The full list possible stats objects is:

```
authenticator, bandwidth, event, interface, node, perpoolnode, pool, protection, rate,  
rule, session, slm, slmpernode, ssl, system, trafficip, virtualserver, webcache, zxtm
```

- `help`: Show help topics. For example:
 - `help overview` - Brief overview of the command line interface
 - `help syntax` - Explain the syntax for entering commands and data
 - `help output` - Explain the output format for commands
 - `help commands` - Describe all of the commands
 - `help classes` - Describe all of the API classes
 - `help <class>` - Show the methods for a particular class. For example, `help Pool`
 - `help <cmd>` - Describe a command. For example, `help Pool.addNode` or `help show`
- `rule`: Upload, download, and syntax check TrafficScript rules on the Traffic Manager.
- `getbackup`: Download a backup from the Traffic Manager.
- `putbackup`: Upload a backup file to the Traffic Manager.
- `download`: Download a specific configuration file from the Traffic Manager, for offline editing or archiving.
- `upload`: Upload a specific configuration file to the Traffic Manager.
- `edit`: Download and edit a specific configuration file from the Traffic Manager, and then upload the modified version.
- `watch`: Repeatedly run a command and watch the output. This is useful for monitoring changes, e.g. keeping an eye on logs or recording stats. For example:

```
admin@127.0.0.1 > watch 10 stats webcache
```

This will show all of the Web cache statistics, updated every ten seconds.

Scripting the CLI

The CLI normally runs in interactive mode, where commands can be entered from the keyboard and are run instantly.

It is also possible to run a script of CLI commands without user input. For example, the following script prints out the Web cache statistics, clears some items from the cache and then prints the Web cache statistics again:

```
System.Stats.getWebCacheEntries
System.Cache.clearCacheContentItems "Intranet" "http" "www.example.com" "**/product/**"
System.Stats.getWebCacheEntries
```

Save the script to a file on the local machine and then execute it as follows:

```
$ ZEUSHOME/zxtm/bin/zcli /home/user/webcache-script
```

The CLI will read the file and run each command found in turn. Providing the script completes successfully, an exit code of 0 (zero) is returned. If an error occurs when running a command, script execution will stop and the CLI will exit with a non-zero return value. However, where `--continue` is specified at the command line, the script will continue regardless of any errors encountered during processing. In this case the return value is still 0, except where the CLI encounters an internal error of some kind (such as the use of incorrect parameters).

To fully automate a script, the username and password must be specified. This can be achieved in two ways:

1. Store the password in a file and provide this file to the zcli script:

```
ZEUSHOME/zxtm/bin/zcli --user username --passfile /home/user/password
/home/user/webcache-script
```

The file containing the password should have suitably restricted permissions so that other users cannot read it.

2. Add the connect command to the start of the script, so it becomes:

```
connect localhost 9090 username password
System.Stats.getWebCacheEntries
System.Cache.clearCacheContentItems "Intranet" "http" "www.example.com" "**/product/**"
System.Stats.getWebCacheEntries
```

Script Output

The output from scripted CLI commands is slightly different from interactive CLI commands. In interactive mode, the output is formatted and spaced to make it more human-readable, spreading the output over several lines if needed. In scripted mode, the output from each command is written on one line only, without any extra padding or formatting.

The output format is JSON-formatted, to facilitate importing and parsing in other programs. Output from commands that take several inputs (for example, multiple pool names) is not presented in a table to highlight the results for each item.

For example, compare the output from the same command run on interactive and scripted sessions.

Interactively:

```
admin@127.0.0.1 > Pool.getNodes [ pool1 pool2 ]
{ pool1: [ "serverA:80", "serverB:80" ],
  pool2: [ "serverC:80", "serverD:80" ] }
```

From within a script:

```
$ ZEUSHOME/zxtm/bin/zcli --user username --passfile /home/user/password
/home/user/getnodes
[["serverA:80","serverB:80"],["serverC:80","serverD:80"]]
```

If you want to keep the human-readable output, then run `zcli` with the `--formatoutput` argument.

Granular Configuration Import/Export with zconf

This chapter discusses the “zconf” command line utility, used to perform import and export on individual Traffic Manager configuration objects.

Introduction

If you are likely to provision a significant number of Traffic Managers on a regular basis, any way to minimize duplication of effort during the provisioning process is a way to decrease time-to-deployment costs. Quite often, users will have a standard set of policies or common pieces of configuration that they want to roll out to a large number of services. From time to time, you might want to make the same configuration change across a large enough number of Traffic Managers.

Users might have some kind of change control database to store policies or configuration files. Subversion (SVN) is an example of a tool that can be used to store and manage changes to not only source code, but configuration files as well. The Traffic Manager includes a tool called “zconf” that can be used to perform granular levels of configuration export and import and to store those [partial] configurations in a tarball. If desired, the tarball can be extracted and checked into one of these change control databases.

Using zconf

To use zconf, run the following command:

```
$ZEUSHOME/zxtm/bin/zconf
```

Note that if \$ZEUSHOME is not set correctly that the zconf utility will not function correctly. This command line utility has a built-in help system. When you run the program with no arguments, you should see the following output (this example taken from the Traffic Manager virtual appliance):

```
root@ubuntu1:~# $ZEUSHOME/zxtm/bin/zconf

ERROR: No command specified.

Usage: /opt/zeus/zxtm/bin/zconf [COMMAND] [OPTIONS] [ARGUMENTS]
Commands:

copy
```

```
diff
export
getdefaultfilter
help
import
info
list
replicate
version
```

For more information on a given command execute:

```
/opt/zeus/zxtm/bin/zconf help <COMMAND>
```

This shows you a list of possible zconf commands. To learn more, read the help for each command.

Exporting a Complete Backup

If you want to take a complete backup of your Traffic Manager's cluster configuration, use zconf's export command. By default, the output of the export command is printed to STDOUT. If you want to save the output to a file, you can use either the --file argument, or redirect the output from STDOUT to a file (as in the example below). On most Linux systems, you can then use the tar command to extract the contents of the tarball (for example, for checking in to a Subversion repository).

```
root@ubuntu1:~# $ZEUSHOME/zxtm/bin/zconf export > backup.tar
root@ubuntu1:~# ls
backup.tar
root@ubuntu1:~# tar xf backup.tar
root@ubuntu1:~# ls
backup.tar conf
root@ubuntu1:~# ls conf
actions      groups      monitors security  users
activitymonitor licensekeys PARTIAL  services  VERSION_8.0
commkey      locations  rules    settings.cfg zxtms
events      locations.cfg scripts  TIMESTAMP
root@ubuntu1:~#
```

Configuration Listings

Configuration backups are stored in a number of plain-text files and organized into a directory tree. The `list` command can be used to list the configuration files in the current running Traffic Manager and any configuration backup or backup archive. Say, for example, that you want to get a list of the virtual servers configured on the current Traffic Manager:

```
root@ubuntu1:~# $ZEUSHOME/zxtm/bin/zconf list vservers
root@ubuntu1:~#
```

This output indicates that the `vservers` directory is empty, and consequently that there are no configured virtual servers. Suppose you want to list the virtual servers in a configuration archive:

```
root@ubuntu1:~# $ZEUSHOME/zxtm/bin/zconf list vservers --conf-path ba
monitors/Full HTTP
pools/Bar
vservers/Foo
```

Notice that while you specified `vservers` as the glob argument to the `list` command, that a pool and a monitor are also listed in the output. This is because all dependencies required to make that virtual server work as expected are printed.

Partial Imports

Assuming that you have a configuration archive tarball in the current directory, in order to import a virtual server (called "Foo" for example) and all of its dependencies you should use the following command:

```
zconf import --include vservers/Foo backup.tar
```

This import will cause the configuration to be replicated across the other members of the cluster.



Similar functionality is also available from within the Admin UI, on the **System > Backups > Partial Backups** page. For more details, see [System > Backups > Partial Backups](#).

Multi-Site Cluster Management

This chapter introduces the idea of combining several Traffic Manager clusters into one centrally managed cluster spanning multiple sites.

Introduction

The multi-site cluster management functionality discussed in this chapter builds on the sophisticated capabilities of the Traffic Manager by adding support for management of multiple distributed physical, virtual or cloud-based Traffic Manager clusters. These clusters could be present at various geographic locations, on various platforms and include varying numbers of Traffic Manager instances. Each might host specific services that you want to administer from one central location.

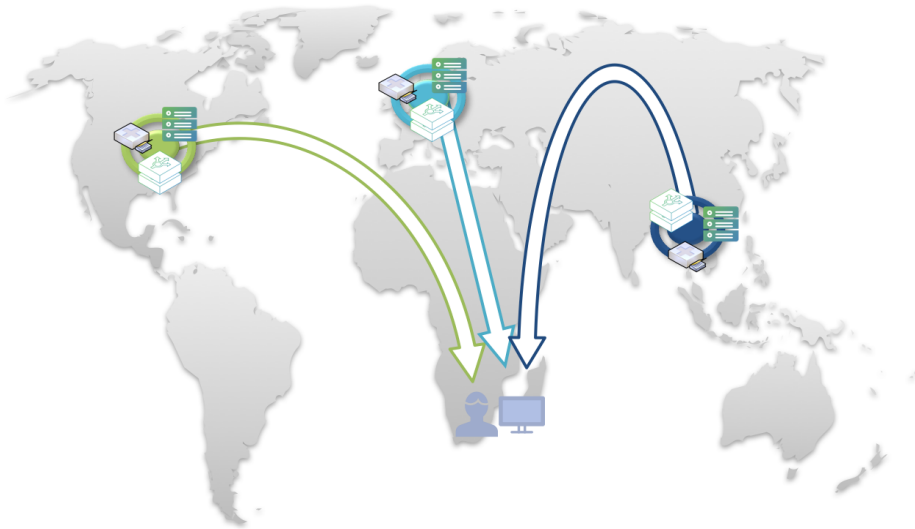

This chapter discusses how your globally distributed Traffic Manager infrastructure can be pulled together into one centrally managed cluster - while retaining the location-specific configuration of your Traffic Manager systems.

This feature is not to be confused with Global Server Load Balancing (GSLB), which involves geographically aware load balancing across services hosted at multiple locations around the world. The implementation of GSLB in the Traffic Manager is discussed in [Global Load Balancing](#).



This chapter assumes you are familiar with the Traffic Manager user interface and general configuration concepts described elsewhere in this manual. It is strongly recommended that you refer to [Key Features in the Traffic Manager Administration Interface](#) before continuing.

Activation and Deactivation

To enable multi-site management functionality, access the **System > Traffic Managers** page of the Admin UI. Tick the **Confirm** checkbox and then click **Enable** in the “Multi-Site Management” section.

Equally, the Traffic Manager can be set back to its original state by deactivating the multi-site capability in the same way. In this scenario, you must first select one of your defined configuration locations as the master configuration to be adopted by all Traffic Managers. All other configuration locations are then removed along with any location-specific configuration values stored for them. Ensure your chosen location is selected in the drop-down list, tick the **Confirm** checkbox and then click **Disable**.



Although configuration locations are removed, GLB locations remain - but in a deactivated state.

Key Concepts

Configuration Locations

Configuration locations are essentially groupings of Traffic Managers, perhaps situated in a particular physical location, that are required to host the same services within an overall cluster. Configuration locations are defined within the **Catalogs > Locations** page, and each of your Traffic Managers is then marked as present at a particular one.

Throughout the Admin UI, services and other configuration aspects can be made location-specific, and only those Traffic Managers marked as present at that location will use them.

This concept provides the ability to combine all of your globally located Traffic Manager application delivery requirements into one centrally administered system. From a single Admin UI, you can now configure and monitor all your services regardless of the complexity of the setup.



It is not mandatory to have your Traffic Managers physically present at a particular location. The concept of a configuration location, as opposed to a GLB location, is mainly as a mechanism to allow virtual grouping within your Traffic Manager cluster.

Clusters

Within a multi-site configuration, a cluster is a group of Traffic Managers deployed over one or more global locations, centrally managed, in order to provide the delivery of application services in a fault-tolerant manner.

Traffic Manager service configuration is replicated between all machines in the cluster. As with non-multi-site environments, the majority of the configuration you make is shared, however multi-site management extends this facility by providing the ability to set location-specific configuration that is only active on those Traffic Managers marked at that location. This provides a form of sub-clustering, or local service delivery. You can edit the overall configuration using the Admin UI of any Traffic Manager in your cluster and it will be replicated to all other Traffic Managers.

A small amount of system configuration is specific to each location (such as local DNS servers), and a small amount of system configuration is specific to a particular machine (such as SNMP settings). To configure location-specific system information, you can use the UI of one of the Traffic Managers in that location, and it is replicated to other Traffic Managers defined at the same location. To configure machine-specific system information, you must use the UI on that machine.

 Where you are intending to join a remotely located Traffic Manager into a cluster, it is essential that you provide the Traffic Manager an “External IP address” first. Furthermore, it is recommended that you ensure the availability of this address, and in particular ports 9080 and 9090 (or whichever ports your Traffic Manager uses for Control communications and the Admin UI), across your cluster prior to adding the new machine. Failure to observe this could cause configuration replication problems within your cluster. For more details about how to set the External IP address, see [Setting Traffic Manager Locations](#). For more information on the Traffic Manager’s network port requirements, see [Default Ports Used by the Traffic Manager](#).

Deployment Scenarios

 All references to “location” in this section refer to **Configuration Locations**. Additionally, all scenarios assume suitable IP/port connectivity to external locations (see earlier).

Create and Manage a Second Traffic Manager Location

As your services grow in popularity and sophistication, you might want to deploy a second Traffic Manager presence in some other global location to be run concurrently.

- First, perform installation and any initial configuration required by each of the new Traffic Managers at the new location. Please note however that when joining an existing Traffic Manager cluster, any non-system specific configuration will be overwritten as the cluster config is replicated to each new machine being added.
- From the Admin UI of each Traffic Manager in turn, run the **Join a Cluster** wizard to connect to your existing Traffic Manager cluster.
- Either pre-define the new second configuration location on your existing cluster, or specify the “new location” option during step 4 of the wizard. Note that specifying a new location during the wizard will not apply a value to the position setting in the location definition. You must do this manually.
- For each subsequent Traffic Manager, while running the wizard you should ensure you select the newly created location during step 4.

Each new Traffic Manager will now be added into the cluster, with a copy of the full configuration, but marked as present at the second configuration location. Any configuration changes that were, or are subsequently, made in a location-specific way will be applied across the whole cluster.

Add a New Traffic Manager to Your Multi-Site Cluster

You can add additional Traffic Managers to any location managed by the Traffic Manager by running the **Join a Cluster** wizard from the Admin UI of the machine you are adding. This will import the configuration of your cluster to your new Traffic Manager and it will appear as a managed machine within the Admin UI.

Merging Two or More Existing Traffic Manager Clusters

In normal cluster joining operations, the joining machine takes on the configuration of your cluster, thus deleting any existing configuration you might have had. What we are attempting to do here is to merge two or more distinct configurations so special care must be taken to preserve the settings on all machines.

The Traffic Manager provides a command line tool “zconf” to perform fine-grained config import/export operations. With this tool we can choose to import the individual services of the secondary clusters into the master cluster config without compromising the existing services. It is also worth making use of zconf’s built-in “dry-run” mode for any import procedures, to ensure that you are fully aware of the expected outcome. For full usage syntax and further information, please refer to the Online Help available directly from zconf.

The intention is to minimize service downtime as best as possible, however it is important to note that there may be service interruptions as Traffic IP addresses are transferred so this is best performed at a time where your Web traffic is at its least.

ATTENTION

In all cases, Ivanti strongly recommends that you back up the configuration on all clusters before attempting this procedure. Ivanti also recommends performing the following procedure with a non-critical system first, in order to observe the likely outcome.

To merge two or more existing clusters

1. Ensure that all your Traffic Managers in all clusters are running the latest Traffic Manager software. Designate one cluster as the master cluster.
2. Set up any new secondary configuration locations on your master cluster.
3. In order to minimize filename clashes, you may wish to rename your virtual servers, rules, pools, etc., on all clusters to uniquely identify them, such as by pre-pending the location name. For example, renaming "Intranet" to "london-Intranet" and so on. This is not mandatory, however it should reduce the chances of config clashes. The default behavior of zconf is to overwrite existing same-name config files when you perform an import, however this is switchable.
4. Export your remote cluster configuration using the **System > Backups** page, and copy the resultant tarball over to your master cluster.
5. Using zconf, import the virtual servers (/vservers) directory from your config backup. zconf will automatically follow dependencies in each virtual server file and import in the relevant supporting files. The only caveat is the use of Java extensions - you might need to import the /jars and /servlets directories manually.
6. These imported services should now be marked as enabled only for the newly defined remote location. This can be achieved on the **Services > Virtual Server > Edit** page by clicking the **Edit setting by location** icon next to the **Enabled** setting. Ensure this virtual server is enabled for the remote location and disabled for all other locations.
7. Use of Traffic IP Groups can cause service conflicts if you have the same IP addresses set up on two clusters. You may need to take the IP addresses in your existing remote cluster offline in order to set up the same IP addresses in your master cluster. As you add in your remote Traffic Managers to the master cluster, you will need to first remove them from the remote cluster, and as a result, any remote IP groups they appear in first.

8. Assuming you have multiple Traffic Manager machines in each cluster, you can disconnect a single Traffic Manager from each and join it to the master cluster, marked as being at the corresponding defined remote location. Note that system specific settings should be applied directly through the Admin UI of the machine they pertain to.
9. This Traffic Manager can be added to the newly created Traffic IP Group and your services should resume.
10. Now take each remaining remote Traffic Manager out of the remote cluster and join them into the master cluster, marked as being at the appropriate location and added to the correct Traffic IP Group. Each will inherit the fully merged configuration, and yet will only respond to the services marked for that location.

Configuration

Setting Up Locations

Locations are listed and modified from the **Catalog > Locations** page. You can also find them through the **System > Traffic Managers** page, by clicking on the **Manage Locations** link. Your defined locations are listed here, with the opportunity to add to, and remove from, the list.



For product variants that include Global Load Balancing, a separate additional section is shown for "GLB Locations". For more details, see [The Traffic Manager DNS Server](#).

Each location is simply defined by its name. Clicking on the location name or associated **Edit** link allows you to modify its settings or delete the location altogether.

Adding a new location can be achieved using the "Add new Location" section under the main list. All new locations are created using an existing location as a template (excluding the case where there are no existing locations).

ATTENTION

This "Based on" mechanism copies any location-specific configuration for the template location to your new location.

Locations can be deleted from the section at the bottom of the associated **Edit** page. Note however that locations in use by one or more Traffic Managers cannot be renamed or deleted. You must first disassociate your Traffic Managers with this location before such operations can be performed.

Setting Traffic Manager Locations

On the **System > Traffic Managers** page, each Traffic Manager listed in your cluster has two new configurable settings:

- **Location:** Select this Traffic Manager's configuration location from the drop-down list.
- **External IP:** When your Traffic Manager's host name is not globally resolvable, you will need to specify an externally available IP address for communications between your cluster members.

Any changes to these settings must first be confirmed by clicking the checkbox next to the **Update** button.

Location-Specific Configuration

A significant change to the way the Traffic Manager handles configuration settings while in multi-site mode can be seen by the addition of a new icon next to each individual setting.

The Location icon



Clicking this icon separates out the setting into multiple instances, one for each configuration location. Clicking the icon again will revert the setting back to being a singular instance - which is used by all locations.

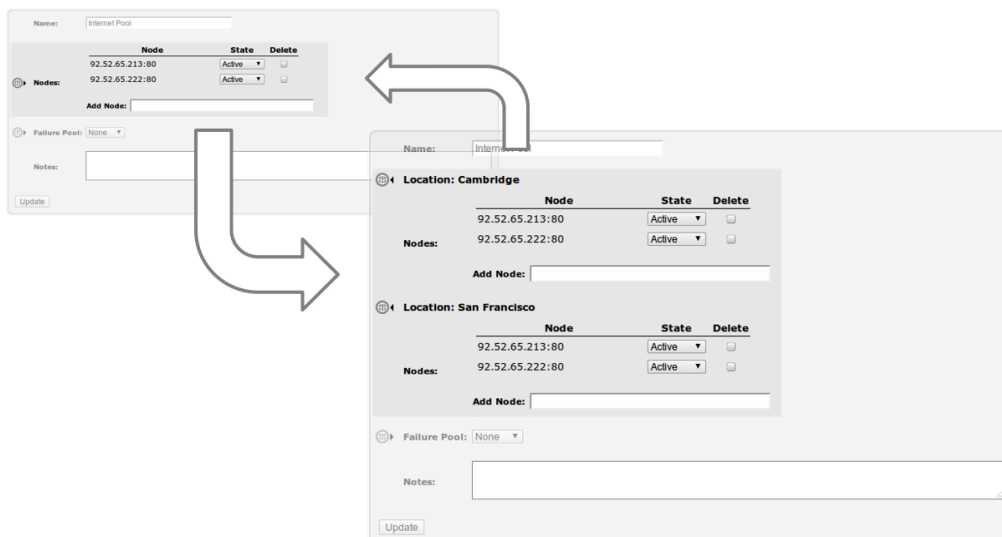

This mechanism allows you to specify individual configuration settings on a per-location basis, while maintaining some global settings that apply to all cluster members.

Home Page Changes

When multi-site cluster functionality is enabled, a modified admin UI home page is presented. The new style is more suited to the environment within which the Traffic Manager is expected to operate. It now shows a number of distinct sections as listed below:

- **Locations:** Your Traffic Manager configuration locations are shown here. Locations defined but not in use will not be shown. Click the location name to view the **Catalogs > Locations > Edit** page for that location.
- **Services:** This shows the list of services marked as enabled and managed by this Traffic Manager installation. A service can be considered as a combination of virtual server, rules, pools and other associated objects. Click the service name to view the **Services > Virtual Servers > Edit** page for that service.
- **Event Log:** This is a quick summary of the event log. It is written-to by all Traffic Managers with the name of the machine in question alongside each entry. The full logs can be viewed by clicking the **Examine Logs** link.

Each of the locations and services are displayed with a suitable status indicator:



Indicates Running OK



Indicates a Warning



Indicates a Serious Error

Warnings are non-critical problems that mean the location or service is still running, but with impaired performance. Errors require action to rectify a problem that is preventing your locations or services from operating. The status applet will reflect these conditions. In the case of warnings or errors, clicking on the location/service name takes you to the **Diagnose** page, where you will see a full explanation of the problem.

The World Map



Click **Activity > Map** to show a world map for enhanced visualization of your locations and services. You can also view the map via the View traffic on World Map link from the **Services > Virtual Servers > Edit** page. This provides a global overview of the locations defined on your system.

The map is designed to be interactive and tools are provided to move around and zoom into a level of detail required for your infrastructure. You can center the map on a geographic location of your choice by holding down the left-hand mouse button and dragging the map to your required destination. You can show traffic for a specific virtual server using the drop-down control at the bottom. The default is for all virtual servers.

Each colored target represents a location, and each small dot that appears on the map represents a user who has issued a request for a particular service. Each user is colored according to the location at which the requested service is hosted. In order to show meaningful information, you will need to enable "Connection Archiving" (also required for viewing advanced connection analytics). If this is currently disabled, you can click the connection archiving is disabled link at the bottom to enable it. This link takes you to the **System > Global Settings** page where you will need to provide a suitable value (for example, 500) for the **recent_conns** setting (the default of 0 disables connection archiving).



To enable the map to show activity corresponding to user locations, the Traffic Manager requires access to a GeolIP database. For more information, see [Using a GeolIP Database](#).

Traffic Visualization

As with Global Load Balancing, activating multi-cluster management functionality on your system automatically enables additional options into the Traffic Manager's existing diagnostic and visualization tools. For more details, refer to [Traffic Visualization](#).

The Traffic Manager DNS Server

The Traffic Manager provides a built-in authoritative Domain Name System (DNS) server capability. This enables the Traffic Manager to host zone files and answer DNS queries.

For Global Load Balancing (GLB) deployments, you can elect to employ the internal Traffic Manager DNS Server or balance traffic to a pool of external DNS Server nodes.

DNS Primer

Introduction

The DNS can be considered the phonebook of the Internet. DNS is used to look up different bits of information about domain names. For instance, your Web browser needs to know which IP address to connect to in order to request a Web site from a Web server. Similarly, when you send an email to someone, your email server needs to know both the domain name and the IP address of the mail server responsible for delivering the message to its recipient. DNS provides the means with which to find this information.

The Layout of DNS

The layout of DNS resembles a top down tree structure. The root of the structure consists of a group of Root Name Servers. Below the root are the Top Level Domain Servers. The names "com" (as in "www.example.com") and "net" are both examples of top level domains. Below the top level, DNS provides no specific classification beyond the term "Name Server".

Delegation of Authority

"Authority" in the context of DNS refers to the responsibility of a name server to handle requests for a given domain. If a name server is Authoritative for servicing DNS requests for anything under example.com, it has been delegated the authority to do so by the higher-level domain server(s). The Traffic Manager's built-in DNS capability is an example of an authoritative DNS server.

Name Resolution

The process of "looking up a piece of information" using DNS is called "resolution". For example, when your Web browser needs to find an IP address for a Web site, it attempts to resolve the domain name to get an IP address. When your email server needs to know which mail server is responsible for delivering a message to a particular domain, it attempts to resolve the "Mail Exchange (MX)" name and its IP address.

As part of its network configuration settings, a computer typically knows of at least one "Name Server". That Name Server in turn provides the computer with responses to DNS requests. Only under special circumstances¹ does a computer send DNS requests to a different Name Server.

Resource Records

Each piece of information for a domain name is held in what is called a Resource Record. Typically, Resource Records are distinguished by type. For instance, when your Web browser wants to know the IP address for `www.example.com`, it sends a query for an "A record" that matches `www.example.com`. If your email server needs to know where it should send a message addressed to `john.smith@example.com`, it sends a query for an "MX record" that matches `example.com`. Some commonly used and supported resource record types are:

- **SOA (Start of Authority)**: Provides a few pieces of useful information about a given domain.
- **NS (Name Server)**: Indicates the domain name of a name server that is authoritative for a given domain. This resource determines how authority is delegated from a higher-level domain to a lower-level domain.
- **MX (Mail eXchange)**: Indicates the domain name of a mail server that should accept mail for a particular domain.
- **A (Address)**: Contains an IPv4 address of a domain name.
- **AAAA (Address)**: Contains an IPv6 address of a domain name.
- **CNAME (Canonical Name)**: Contains an alias for a domain name.
- **PTR (Domain Pointer)**: Used for reverse lookups, from IP back to DNS name.
- **SRV (Service Record)**: Defines the hostname and port number of servers used for specified services.

¹As a practical example this would be at the hands of a DNS administrator who is performing testing.

- **TXT (Text Message):** Contains an arbitrary human readable text message, used for many purposes.

Zone Files

Resource Records are typically stored in text files on authoritative DNS servers. A zone file contains a set of records that are specific to a domain. Each zone file must contain at least an SOA record and an NS record.

The Traffic Manager supports zone files with the following example format:

```
$TTL 604800 ; This TTL declaration applies to all
                ; records defined below that do not define
                ; their own TTL

; In this file, @ means the "current origin domain"

@ IN SOA ns.example.com. root.example.com. (
        1          ; Serial
        604800     ; Refresh
        86400      ; Retry
        2419200    ; Expire
        604800     ; Negative Cache TTL
)

@ NS ns
ns A 192.168.0.1
@ NS ns.example.com.
ns A 192.168.0.254

@ IN MX 1 host
@ IN MX 2 mail2.example.net. ; note this is
                ; in another
                ; zone/domain

host IN A 192.168.0.2
      AAAA 2001:db8:85a3:0:0:8a2e:370:7334

$TTL 1w2d3h4m5s ; The TTL defined here overwrites the
                ; setting above and applies to all the
                ; records below it that do not define their
```



```
        ; own TTLs.

foo.bar      A    192.168.0.3 ; An example of a
                ; relative address:
                ; foo.bar.example.com.
foo.bar.example.com. A    192.168.0.4 ; An example of an
                ; absolute address

alias        CNAME host

_sip._udp    SRV   0 5 5060 sipserver
sipserver    3600 A    192.168.0.5 ; This record has
                ; its own TTL (3600)

text1        TXT   "This is a TXT record"
*.wildcards  TXT   "This is a wildcard TXT record"
```

The Traffic Manager parses zone files using a top-down approach, and it assumes inheritance from the preceding line where indentation occurs.

If you modify or update your zone file after the initial deployment, you must increment the "serial" counter to ensure the DNS service is made aware of the change.

A zone file typically contains at least one TTL (Time To Live) definition, in particular at the top of the file. The Traffic Manager uses this value to determine how long clients should wait before refreshing DNS-related information. The following rules and observations apply to TTL values in zone files:

- If you do not define a TTL value in your zone file, the Traffic Manager uses instead the Negative Cache TTL value from the SOA definition. The Negative Cache TTL is normally used as a TTL in "negative responses". That is, NXDOMAIN (domain name not found) and NODATA (domain name found, but no records of given type).
- All records with the same domain name should have the same TTL value.
- A TTL can be specified as a single number of seconds or the alternative format of 1w2d3h4m5s to mean 1 week, 2 days, 3 hours, 4 minutes, and 5 seconds. The alpha components of this format are case insensitive, and they can be specified as uppercase, lowercase, or mixed (for example, 3W1h5M4s).

The Resolution Process

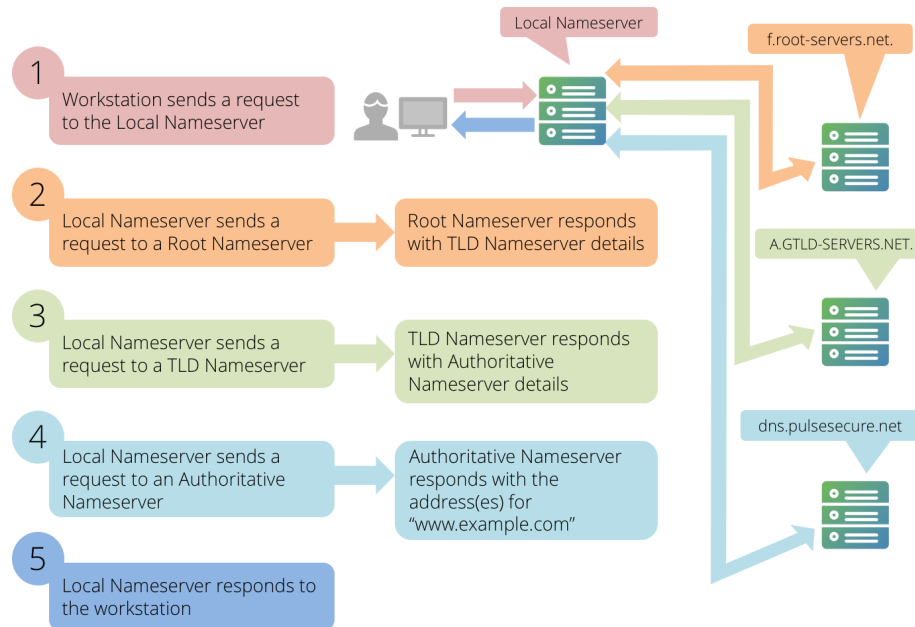

The following steps detail how a user's client workstation resolves a Web site's URL to a correct IP address:



If you are using the Traffic Manager's built-in DNS server capability, "dns.example.com" in this scenario might correspond to the Traffic Manager as the authoritative DNS server.

1. When a user opens a Web browser and types `www.example.com` into the address bar, their workstation needs to send an HTTP request to a Web Server. Before it does so, it must resolve the domain name of the Web server. Their workstation sends a DNS request to the Local Name Server in order to determine the IP address.
2. The Local Name Server then refers to its Root Hints zone file. The Root Hints zone file contains a list of domain names and IP addresses for the Root Name Servers. The Local Name Server then sends a DNS request for `www.example.com` to one of the Root Name Servers listed in its Root Hints zone file. "f.root-servers.net." compares the DNS request to the list of zones for which it is authoritative. In this case, it is authoritative for the "." domain. Within the zone file for ".", there are delegation records for all Top Level Domains. The Top Level Domain for `www.example.com` is ".com.", so "f.root-servers.net." sends a DNS response back to the Local Name Server containing the domain names and IP addresses for the Name Servers that are authoritative for ".com."

3. A.GTLD-SERVERS.NET¹ is listed (among others) as authoritative for the ".com." domain, so the Local Name Server then sends the same request to it. A.GTLD-SERVERS.NET then responds with a list of name servers authoritative for "example.com."
4. Since "dns.example.com." is an Authoritative Name Server for the "example.com." domain, the local name server then sends it the request. Because "dns.example.com" contains all of the Resource Records for "example.com." in its Zone Files, it provides the IP addresses (in the form of one or more "A" records).
5. Now that the Local Name Server has the IP address, or IP addresses, for www.example.com, it passes on the information to the workstation that made the initial DNS request. The machine that performed the recursive lookup is the Local Name Server.

The type of query the client made is known as "recursive" due to the fact that the local name server searches the DNS tree from top to bottom. A "non recursive" query might also be sent. This means that only a name server authoritative for the domain name being asked about should provide the answer; otherwise, the name server receiving the query should refuse to respond to the query.

In addition to returning the final DNS result to the end user, the Local Name Server usually caches the results of the intermediate lookups. Consequently, not every request requires the full set of DNS requests illustrated above. For this reason, the Local Name Server can be referred to as either a "Recursive Name Server" or a "Caching Name Server".

Supported DNS Features

The Traffic Manager DNS Server is designed to conform to the majority of the DNS technical specifications contained in RFC 1034 and RFC 1035. This section lists the implemented features and exceptions.

Implemented Features from RFC 1034

The Traffic Manager DNS Server implements the following features:

- Authoritative server behavior.
- Domain name space database.
- Positive and negative answers (NODATA, NXDOMAIN, SERVFAIL, FORMAT ERROR, REFUSED, NOT_IMPLEMENTED).

¹"GTLD" is an acronym for "Global Top Level Domain".

- Delegations (also known as referrals).
- Class IN of the DNS database.
- The ANY record type.
- Wildcard DNS records (see also RFC 4592).

Implemented Features from RFC 1035

The Traffic Manager DNS Server implements the following features:

- Supported record types:
 - A
 - CNAME
 - MX
 - NS
 - PTR
 - SOA
 - TXT
- Other supported record types:
 - AAAA (see also RFC 3596)
 - SRV (see also RFC 2782)
- Supported DNSSEC record types (see also RFC 4034):
 - DNSKEY
 - RRSIG
 - DS
 - NSEC
 - NSEC3
 - NSEC3PARAM

- DNS answers use message compression (see also RFC 1035, section 4.1.4).
- UDP and TCP are fully supported as transport protocols with IPv4 and IPv6.
- Zone text files (also known as "master files"), as defined in RFC 1035 section 5, are supported. The Traffic Manager can process the following aspects of zone files:
 - Definition of resource records of supported types listed in this section
 - The \$TTL directive
 - The \$ORIGIN directive
 - The use of parentheses and multiline record definitions
 - The @ sign
 - Comments placed after a semicolon (;)
- Reverse lookup using in-addr.arpa domain is supported, as in RFC 1035 section 3.5.

Exceptions for RFC 1034

The following features are not implemented or supported:

- Resource record classes CS, CH, and HS.
- Inverse queries (these queries are made obsolete by RFC 3425).
- Zone transfer.
- Status queries (experimental).
- Completion queries (obsolete).

Exceptions for RFC 1035

The following features are not implemented or supported:

- The \$INCLUDE directive.
- The use of the backslash (\) operator to define a literal or control character. For example, "." to place a dot character in a label.

- \DDD where each D is the octet digit corresponding to the decimal number described by DDD. The Traffic Manager assumes the resulting octet is text and does not check it for special meaning.

Other Implemented Features

The Traffic Manager DNS Server implements the following features:

- Case sensitivity is fully supported.
- RFC 2308, "Negative Caching of DNS Queries", is fully implemented.
- EDNS(0) is implemented, as per RFC 6891, "Extension Mechanisms for DNS". The Traffic Manager makes use of EDNS to handle UDP response sizes that are larger than 512 bytes. The Traffic Manager additionally uses the EDNS "DO" flag to determine whether incoming DNS questions indicate DNSSEC support, as per RFC 3225. No further EDNS features are supported.
- The DNSSEC protocol is supported, as defined in the following RFCs:
 - RFC 4033, "DNS Security Introduction and Requirements"
 - RFC 4034, "Resource Records for the DNS Security Extensions"
 - RFC 4035, "Protocol Modifications for the DNS Security Extensions"
 - RFC 5155, "DNS Security (DNSSEC) Hashed Authenticated Denial of Existence"
- For DNSSEC support, note that:
 - The Traffic Manager is able to parse signed DNSSEC zone files.
 - The Traffic Manager is able to answer with DNSSEC signed records in a standards-compliant manner.
 - The Traffic Manager checks the expiry time on DNSSEC signatures in a zone file when the zone is associated with a virtual server, and periodically every hour thereafter. If a signature has expired, or expiry is due to occur within 7 days, the Traffic Manager generates an event through the Alerting system (see CHAPTER 21, "Event Handling and Alerts").

Other Excluded Features

The following features are not implemented or supported:

- Classless delegation, as per RFC 2317, is not supported.

- RFC 3597, "Handling of Unknown DNS Resource Record (RR) Types", is not supported.
- For DNSSEC support, note that:
 - The Traffic Manager does not provide tools to sign zone files.
 - The Traffic Manager does not provide tools to manage the cryptographic keys lifecycle.

Configuring the DNS Server

This section describes how to configure your Traffic Manager as an authoritative DNS server.

Configuration Summary

Use the Admin UI, REST API, SOAP API, or command-line interface to perform the following tasks, each of which is described in detail later:

- Upload your DNS zonefile to the "Zonefiles" Catalog.
- Create a "zone" configuration to define an "origin domain" and encapsulate the uploaded DNS zonefile.
- Create a DNS-configured Virtual Server and assign to it one or more zones to serve incoming DNS requests.

Your zonefiles can be reused and associated with more than one zone configuration to enable multiple zones to advertise the same hosts under different origin domains. Furthermore, a DNS Virtual Server can utilize any number of zones in order to provide an authoritative DNS service covering many domains.



If you associate a single zonefile with more than one zone configuration, Ivanti recommends avoiding redefining the domain origin (using the \$ORIGIN declaration) inside the zonefile.

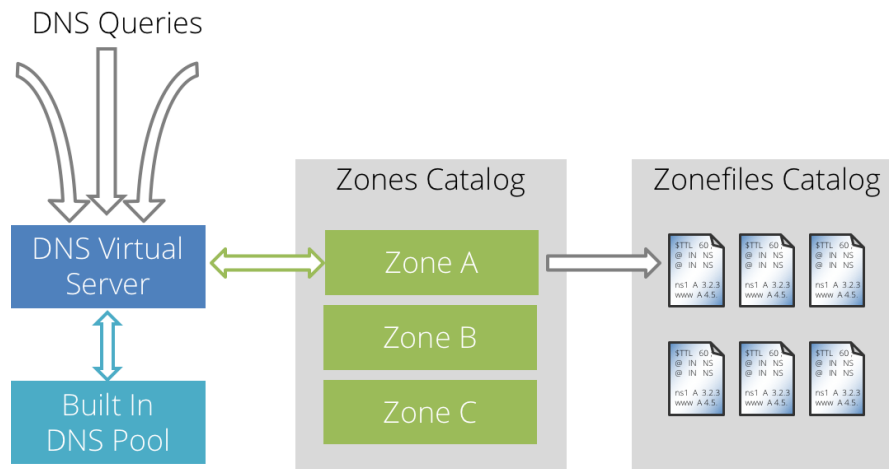

Using this mechanism, the Traffic Manager itself answers DNS requests using its built-in DNS capability, rather than passing the request on to a pool of external DNS server nodes.

Uploading DNS Zonefiles to the Traffic Manager

A zonefile is a text file containing the resource records that instruct the Traffic Manager what answer to return when it receives a DNS query for a domain. Each zonefile must conform to the format prescribed in RFC 1034 and RFC 1035.

The Traffic Manager stores your zonefiles in the "DNS Zonefiles" Catalog. Choose **Catalogs > DNS Server > Zone Files Catalog** to upload a new zonefile.



The Traffic Manager does not validate the contents of your zonefile until you associate it with a zone configuration. Any detected anomalies are added to the event log.

Setting Up Traffic Manager Zones

The Traffic Manager does not directly access and parse uploaded zonefiles. To use a zonefile, first create a zone configuration that references a zonefile in the catalog.

Each zone also contains a domain "origin" that the Traffic Manager uses with the resource records in the attached zonefile. In other words, all domains listed in the zonefile branch off of this origin and take the form of <domain>.<origin>.

For example, if your origin is "example.com", you can specify domains "www" and "www.support" in your zonefile to create domain lookups for "www.example.com" and "www.support.example.com".

To create a zone configuration, choose **Catalogs > DNS Server > Zones Catalog**. Type the name and domain origin for your zone, and select a previously uploaded zonefile to use. Click **Create Zone** to save your zone configuration.

When you create a zone configuration with an attached zonefile, the Traffic Manager reports any syntax issues with the contents of the zonefile in the event log.

Configuring a DNS Virtual Server

You typically create a Virtual Server to handle incoming DNS requests and pass them on to a pool of back-end DNS server nodes. With the internal DNS server capability, you instead configure a DNS Virtual Server to use the built-in DNS pool "builtin_dns", and link to it the desired zone configuration to use for DNS lookups.



To ensure full service coverage, Ivanti recommends that you deploy both a DNS (UDP) and a DNS (TCP) virtual server.

To create a DNS Virtual Server

1. Choose **Services > Virtual Servers**.
2. In the "Create a new Virtual Server" section, enter the following:
 - **Virtual Server Name:** The identifying name for this virtual server.
 - **Protocol:** Select "DNS (UDP)" or "DNS (TCP)" from the drop-down list.
 - **Port:** Choose the incoming port number that this virtual server listens on (typically "53").
 - **Default Traffic Pool:** Choose "builtin_dns" to instruct the Traffic Manager to use its own DNS capability.
3. Click **Create Virtual Server** to create this virtual server.
4. On the Virtual Server edit page, click **DNS Server** to select one or more zone configurations you want this virtual server to use for DNS lookups.
5. To enable your Virtual Server, set **Enabled** to "Yes" on the Virtual Server edit page or click the play icon next to the Virtual Server name on the Traffic Manager home page.



The default traffic pool "builtin_dns" is only available for Virtual Servers that use an internal protocol of DNS (TCP) or DNS (UDP), and is not listed in, or selectable from, your normal pool list.

You can also modify the following settings on the **Virtual Server > Edit > DNS Server** page:

- **dns!edns_udpsize:** The message size advertised in UDP responses under EDNS.
- **dns!max_udpsize:** The maximum size allowed for UDP responses.
- **dns!verbose:** To assist debugging efforts, enable this setting to instruct the Traffic Manager to provide a more verbose level of DNS information in the event log. For typical production use, disable this setting.
- **dns!rrset_order:** The DNS record response order. Set to "Fixed" to instruct the Traffic Manager to return DNS records of the same name and type in the order defined within a zone file. Set to "Cyclic" to instruct the Traffic Manager to use a rotating round-robin system. That is, for successive responses, DNS records of the same name and type are returned in a cyclical manner - with each record moving one place forward in the response. This method can facilitate more efficient load distribution.



Caching resolvers can, in some cases, preserve the order of DNS records in the answers they receive from authoritative servers.

Global Load Balancing

This chapter discusses the Traffic Manager's Global Load Balancing (GLB) capability.

i This functionality might not be available in your Traffic Manager variant. Contact your support

Introduction and Prerequisites

GLB is designed to provide business continuity and improved performance across globally distributed locations. This capability is based upon a technique known as Global Server Load Balancing (GSLB). The Traffic Manager uses geographic load balancing and failover functionality to enable the distribution of traffic across these locations based on availability, performance and user-defined rules.

This chapter describes how to plan and configure GLB in your Traffic Manager deployment. To perform the configuration described here, you must be familiar with standard system administration tasks, including networking and DNS administration. For a background on DNS, see [DNS Primer](#).

For further details about the principles of GSLB, see [About Global Server Load Balancing](#). Ivanti recommends that you also refer to the background whitepapers and documentation published on www.ivanti.com and the Pulse Community Web site at <https://community.pulsesecure.net>.

About Global Server Load Balancing

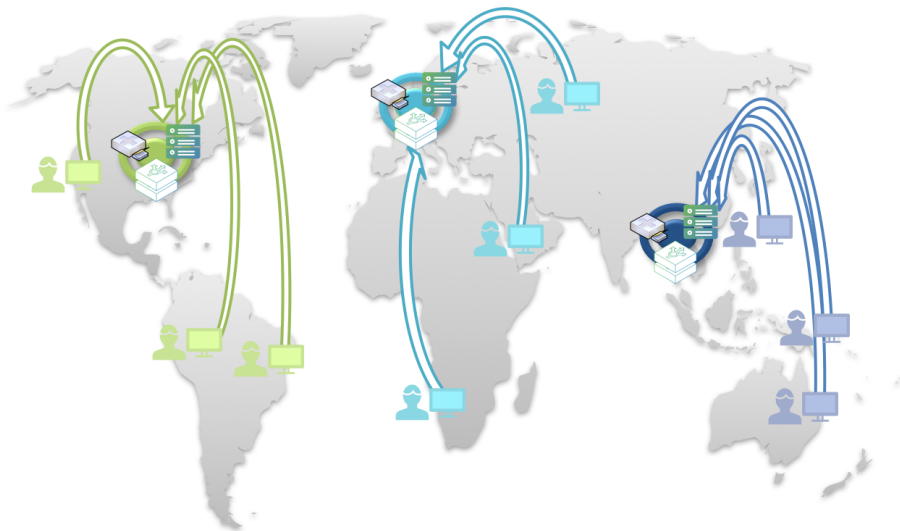

Global Server Load Balancing (GSLB) is a technique that manages how clients are connected to a particular geographic location when a service is hosted in multiple locations.

- In an "Active-Passive" (or Primary-Backup) configuration, one location is nominated as active for each service. The other locations are idle for that service. If the active location becomes unavailable, one of the passive locations becomes active and all clients are directed to it.
- In an "Active-Active" (or multiple Primary) configuration, all locations are used and clients are load-balanced between them based on location performance and proximity.

The primary purpose of a GSLB system is business continuity, to ensure that services are always available even when one or more service locations becomes unavailable.

A second purpose of GSLB is to improve the customer experience. In other words, the purpose is to load balance each user to the best location from a choice of several. The choice can be based on location performance and proximity, so that clients are directed to the location that is closest and is performing the best. With this capability, the client gets the best possible level of service.

GSLB Within the Traffic Manager

The Traffic Manager implements GSLB techniques as the Global Load Balancer (GLB) feature. The GLB feature causes the Traffic Manager to add location-awareness to DNS lookups performed by end-users, so that the result of the DNS lookup is dependent upon its source.

You can add GLB Services to any Virtual Server using the DNS protocol. When a DNS request is received at this Virtual Server, the Traffic Manager forwards the request to the associated Pool. This might be either the built in internal DNS server pool (see [The Traffic Manager DNS Server](#)) or it might be a pool of external DNS servers. With both of these options, you must configure the pool back ends to return multiple "A" records, containing all IP addresses for the domain names which are to be resolved, across all locations.

If the domain name resolved matches the domain name in a GLB Service attached to the Virtual Server, the Traffic Manager filters the list depending upon the GLB Service configuration, before returning to the end user only the IP address or IP addresses that are appropriate for the end user's location.

You can deploy the Traffic Manager in each GLB Location so it can monitor local performance and availability, although this is not necessary. All monitoring can be performed remotely should you require your Traffic Managers in some alternative location. Your Traffic Managers exchange monitoring information with their peers, regardless of their actual location, so that all Traffic Managers can work together to coordinate their operation.



A GLB Service only filters "A" records, not "AAAA" records. If the DNS response contains any "AAAA" records, the Traffic Manager passes the response through untouched.

Deployment Planning

Traffic Manager Positioning

The Traffic Manager contains a database of geographic locations for the public IPv4 address space and acts either as an authoritative DNS server or as a proxy for a separate back-end DNS service. You deploy your Traffic Managers either in parallel with, in front of, or instead of your current DNS infrastructure. When the Traffic Manager receives a DNS request from a client, it determines the response from either the internal or external DNS service it is managing. The Traffic Manager then modifies the response, based on a number of configurable metrics (including geographic location), before sending it back to the client.

To see more information about the Traffic Manager's built-in DNS capability, see [The Traffic Manager DNS Server](#).

Deployment Methods

A DNS domain needs a set of name servers that are nominated as authoritative by the name servers for the parent domain. Where the parent domain is a public domain, such as a global top level domain, you modify the authoritative name servers for your domain through a DNS registrar.

To use GLB with a hostname, you can deploy the Traffic Manager in one of two ways:

- With an "Inline" deployment, your Traffic Managers become the authoritative DNS servers for the domain containing the hostname. By modifying the delegation records in the parent domain, you ensure that all DNS traffic for the domain is directed to your Traffic Managers. The Traffic Managers either serve the requests using the built in DNS server capability, or forward it to your existing DNS servers, and then manipulate the responses on hostnames with GLB configured.
- With a "Parallel" deployment, the Traffic Managers are not authoritative for the domain containing the hostname, and you instead create a parallel hostname in a separate DNS domain for which the Traffic Managers are authoritative. In the existing domain, create a CNAME to the parallel hostname in the other domain, and configure a GLB Service with the parallel hostname.

When your (Authoritative) Name Servers receive a DNS request for the hostname, they respond with a CNAME, which causes the client to make a DNS request for the parallel hostname from a Traffic Manager. As with the Inline deployment, the Traffic Manager either processes the request using the built in DNS server, or forwards it to another authoritative DNS server. The response is then manipulated according to the GLB Service configuration.

A Parallel deployment can be more complex to configure, but is a better solution if you are managing large numbers of domains or if you expect to make frequent changes.

Inline Deployment

For an Inline deployment, the Traffic Manager operates as the authoritative name server for the entire domain containing the hostname. A DNS request is received on a DNS Virtual Server, and processed by the associated Pool, which might be either the built in DNS server or an external pool of DNS servers.

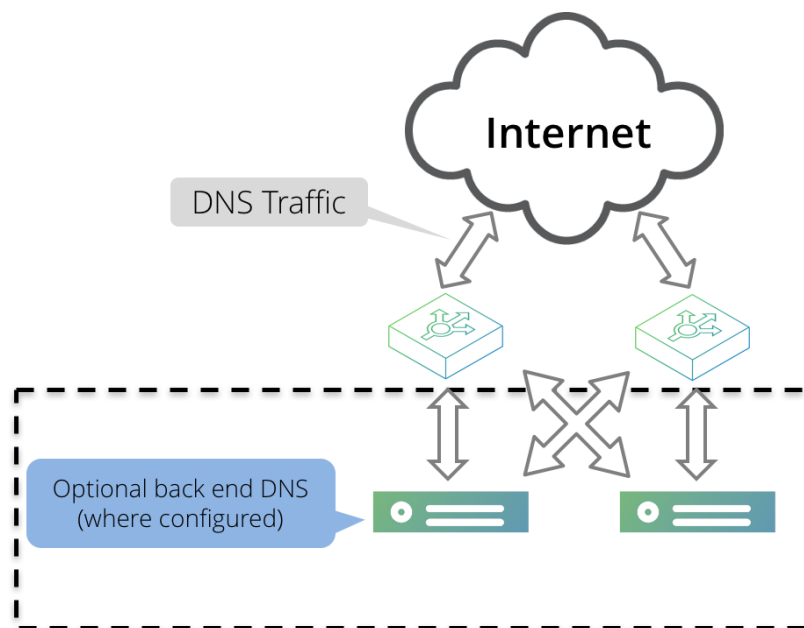

To deploy the Traffic Manager using the Inline method, configure the built in DNS server or external DNS servers to return multiple "A" records for each hostname you want to globally balance. To configure the built in DNS server, see [The Traffic Manager DNS Server](#).

Then create DNS Virtual Servers on your Traffic Managers. For greatest coverage, Ivanti recommends creating both a DNS (TCP) and a DNS (UDP) Virtual Server. Set the default pool to either the built in DNS Server pool or your external DNS servers, depending on your requirements. While using an external DNS pool, the Traffic Managers proxy all DNS requests to these Name servers.

Add a GLB Service to your DNS Virtual Servers for the hostname to be globally balanced, and make the Traffic Managers authoritative for that domain by updating the delegation records in the parent domain.

The parent domain contains a number of record types:

- **NS (delegation) records:** Hostnames of the DNS servers that are authoritative for the domain. You typically provide multiple NS records.
- **A and AAAA (glue) records:** For every NS record, you must provide either an A record or an AAAA record. Particularly if the hostnames in the NS records are contained in your own domain, the parent zone needs to contain glue A or AAAA records, which provide the IP addresses of the hostnames.

To update the parent domain, first determine which organization manages the parent domain. This might be an external DNS registrar, another part of your organization, or a domain that you manage yourself.

To update the delegation records with a DNS registrar

1. DNS settings controlled by your DNS registrar can typically be configured through a Web based interface. Contact your DNS registrar for details about its configuration interface.
2. Login to your domain configuration page and locate the list of name servers.
3. Each record consists of a Fully Qualified Domain Name (FQDN) and, optionally, corresponding IP addresses. To update these records, replace the FQDNs and IP addresses for your current DNS servers with those of your Traffic Managers.

For further assistance with this procedure, contact either your DNS provider or your DNS registrar.

After your parent domain's delegation records have been updated, the Traffic Manager receives all DNS requests for the hostname to be load balanced. On receiving a request, the Traffic Manager forwards it to the appropriate DNS back end, and receives a list of IP addresses as a response. The Traffic Manager processes this list to select precisely which IP address it returns to the end user.

Parallel Deployment

To create a parallel deployment, you configure a CNAME for your DNS entry that points to a hostname in a separate domain, often a subdomain of the domain that you own. You then configure GLB for the parallel hostname, in accordance with the Inline deployment method.

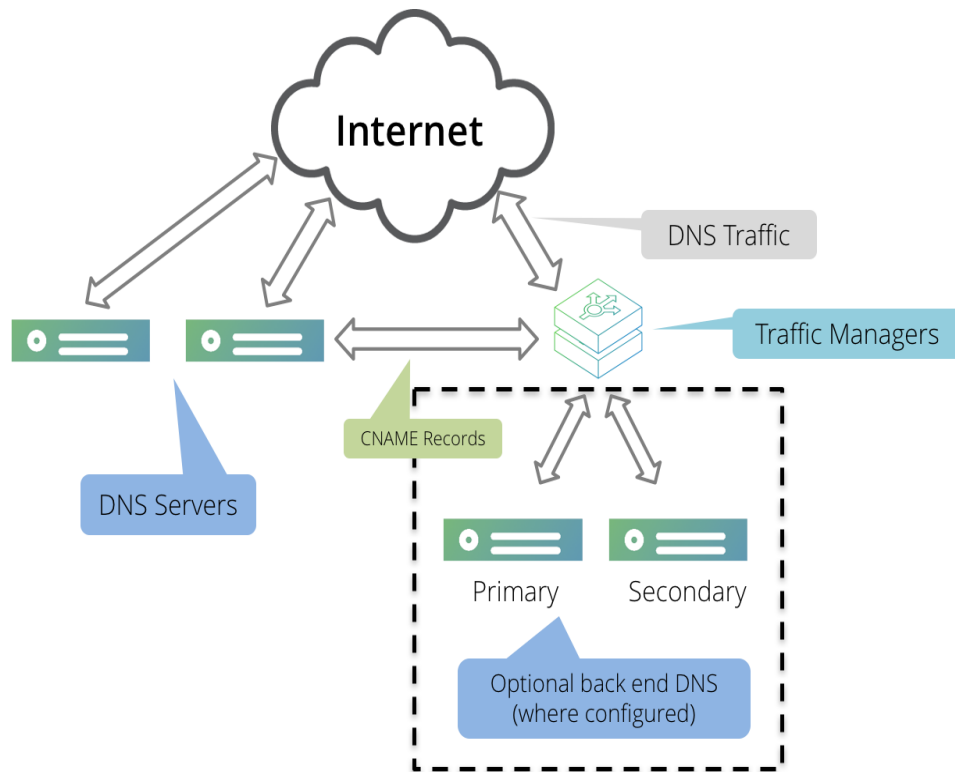

Suppose, for example, that you manage the domain "example.com" yourself, and want to enable GLB on "www.example.com", using a parallel deployment with the alternative hostname "www.gslb.example.com".

You configure the name servers for "example.com" to fulfill two roles:

- Provide the redirection from "www.example.com" to "www.gslb.example.com".
- Delegate authority for "gslb.example.com" to the Traffic Manager.

Using either the internal Traffic Manager DNS server capability, or through a separate pool of back-end DNS servers, you then host the "gslb.example.com" domain on the Traffic Manager. In the "example.com" zonefile, add the following entries:

```
; Delegation for gslb.example.com using the Traffic Manager.
gslb.example.com.    IN NS  stm1.gslb.example.com.
                    IN NS  stm2.gslb.example.com.

; Glue records for gslb.example.com
stm1.gslb.example.com.  IN A  192.0.2.11
stm2.gslb.example.com.  IN A  192.0.2.12
```



```
; CNAME for www.example.com to parallel GLB-enabled name.  
www.example.com.      CNAME  www.gslb.example.com.
```

When a DNS client looks up the domain name `www.example.com`, it contacts the name server for the `example.com` domain. This name server returns a CNAME response corresponding to "try `www.gslb.example.com` instead". Because it is authoritative for the `example.com` domain, the name server also gives additional information concerning the names and IP addresses of some name servers for `gslb.example.com` (which, in this case, are your Traffic Managers).

The DNS client now sends a request for `www.gslb.example.com` to the Traffic Manager, and that Traffic Manager in turn obtains the list of IP addresses for all your GLB Locations (using either its internal DNS service or by querying your back-end DNS servers). The Traffic Manager processes this list, returning back one or more A records containing the IP address or IP addresses of one of the GLB Locations.

If, in a parallel deployment, your DNS servers are not your Traffic Managers, the DNS servers for the parallel hostname (`www.gslb.example.com`) must not return the unmodified A records for the original hostname (`www.example.com`). Therefore, Ivanti strongly recommends that your top level DNS servers are different name servers from your back-end DNS servers.



It is also possible, although complex, to use split horizon DNS. However, with this approach care is needed to ensure that unmodified responses do not leak out.

If your back-end DNS servers are all Traffic Managers, this problem does not occur. Instead, you must ensure that the GLB Service is configured on all DNS Virtual Servers publicly serving the globally load balanced hostnames.

A parallel deployment can be more complex to deploy because you must create and configure a new DNS subdomain. However, it is a more flexible and suitable technique if you expect to change your DNS configuration frequently, or want to centralize the configuration for many domains as you can use the same subdomain for each one.

For example, you can alias many different domain names (`www.example.com`, `www.mysite.com`, and `www.example.org`) to the same CNAME (`www.gslb.example.com`), which is in turn hosted by your Traffic Managers. You can then configure many domains centrally from a single CNAME by setting up the back-end DNS service of your Traffic Manager deployment accordingly.

The Time-to-Live (TTL) Field

When you make a change to any of your DNS records, it is possible that the change might not have an immediate effect on your Internet traffic. This is because each DNS record contains a Time-to-Live (TTL) field. The TTL field typically tells downstream DNS servers to cache this record for a given number of seconds, after which time it should send a new request. To ensure that your records propagate across the Internet in a timely fashion, Ivanti recommends a TTL value between 30 and 60 seconds.

Components of a Traffic Manager GLB Deployment

This section provides an overview of the Traffic Manager GLB architecture and outlines the key concepts of a working global load balancer.

Ivanti recommends that you read this section before configuring your GLB deployment. To configure GLB, see [Configuring GLB](#).

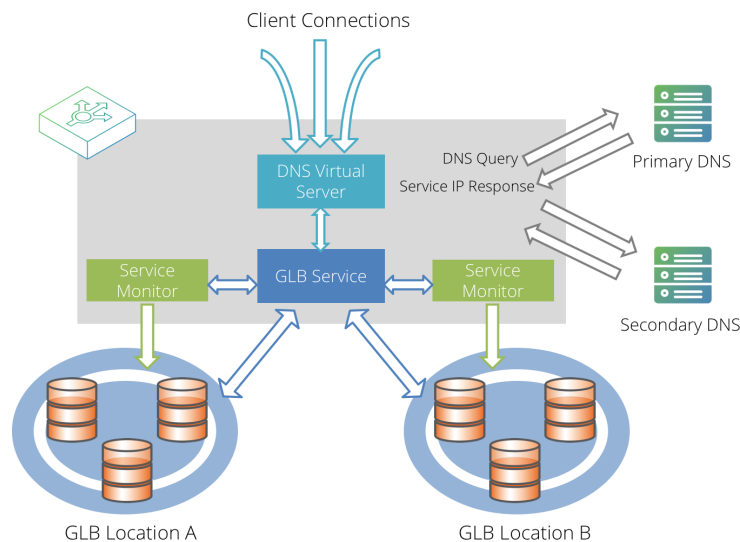

GLB Locations

The Traffic Manager considers GLB Locations as independent sites that you use to provide your service. Often, a GLB Location represents a datacenter. You might have two or more GLB Locations in different countries around the world, deployed in order to provide a suitable application delivery infrastructure appropriate to local requirements, or for full disaster recovery for critical systems. Your Traffic Managers do not need to be physically present at a GLB Location, although there are performance and availability benefits for being so.

The Traffic Manager uses a Service Monitor to determine the health of the service being provided by a GLB Location. When a client makes a DNS lookup, the Traffic Manager's GLB Service chooses the GLB Location most appropriate for that client. The Traffic Manager then returns a DNS response to the client directing it to the chosen GLB Location.



GLB Locations are an independent concept to Configuration Locations, as discussed in [Configuration Locations](#). If you are implementing GLB, a Traffic Manager might be marked as present at a Configuration Location, but this has no bearing on the GLB services it manages.

Traffic Managers in different locations can use the same DNS servers. However, for performance and reliability reasons, Ivanti recommends that you configure your Traffic Managers to use DNS servers local to them. To achieve this, combine your GLB Locations with the Configuration Location functionality described in [Multi-Site Cluster Management](#).

GLB Services

A GLB service represents the global load balancing configuration that you want to use for a set of DNS domains. Within a GLB service, you configure the following core information:

- The domains the GLB service applies to.
- The GLB Locations that are hosting the services for those domains.
- The load-balancing algorithm to use for your GLB Locations.

You can also configure additional settings:

- The TTL (Time-To-Live) value, which determines how frequently a DNS client checks the DNS information for the domain.
- Draining: you can drain a GLB Location to stop clients being directed to it.
- Monitors: you can configure one or more Service Monitors to check the correct operation of the services and hosts in each GLB Location.
- Logging: you can log every DNS request and response for inspection and debugging.

GLB Configured Virtual Servers and Pools

Each Traffic Manager listens for incoming DNS requests through a specially configured Virtual Server for your GLB Services. This Virtual Server uses DNS (UDP or TCP) to load balance traffic to a pool consisting of your back-end DNS Server nodes.

If you have multiple GLB Services assigned to a Virtual Server, the Traffic Manager picks the correct GLB Service based on the domain being requested.

DNS Servers

You create a pool containing your DNS Servers as nodes, and the Traffic Manager load balances this pool according to the load balancing algorithm defined within the pool configuration. If one DNS server node times out, an alert is raised and the Traffic Manager handling the request tries the next DNS server.

You might want to install your Traffic Managers in the same physical location as your DNS server(s) for performance reasons, but this is not mandatory.

Service IP Addresses

For the Traffic Manager to manipulate the answers it sends to a client, it must know which IP addresses belong to which GLB Locations. Service IP addresses correspond to the IP addresses that your DNS Servers return, typically using a round-robin mechanism, when queried for the domains you are managing.

Service Monitors

You can configure each individual GLB Service with a list of Service Monitors that should be run in each GLB Location. All of the Service Monitors you define for a GLB Location must succeed for the Traffic Manager to consider that GLB Location in its load balancing decision for that GLB Service.

If any monitor fails (within the failure threshold limits defined in the monitor), the entire GLB Location is marked as down and those Traffic Managers that detected the failure avoid this location when load-balancing clients.



In some circumstances, one or more Traffic Managers in your geographically distributed GLB deployment might not detect the same failure as their peers, due perhaps to an isolated network outage. These Traffic Managers can continue to use the GLB Location that their peers have detected as unavailable, provided the Service Monitor returns to them a successful response.

Service Monitors typically test a specific named service IP address or hostname for correct operation. For example, you might configure a Service Monitor to test the primary server load balancer in that GLB Location to verify that it is correctly serving content. The primary server load balancer has the IP address that is published using DNS for that service in that GLB Location.

You can assign multiple Service Monitors to a GLB Location if you want to test several services or hosts for correct operation.

If you have configured GLB Locations in multiple GLB Services, the Service Monitors for each operate independently. Even though a GLB Location might fail for one GLB Service, the other GLB Services continue to use that GLB Location if their monitors are successful.

Service Monitors can optionally provide performance information to the load balancing algorithm if you are using a "Load" or "Adaptive" load balancing method. The load balancing algorithm then sends more traffic to the GLB Location that reports the best performance.

Performance data is based on the time the Service Monitor takes to complete. In other words, this is the response time of the monitored GLB Location.

Configuring GLB

The Traffic Manager uses the components described in [Components of a Traffic Manager GLB Deployment](#) to perform global load balancing. This section describes how to configure each of these components within a typical Traffic Manager deployment.

Overview

For the Traffic Manager to perform load balancing between geographically separate locations, you must:

- Define the GLB Locations to be served.
- Create Service Monitors to monitor the availability of each of your GLB Locations.
- Create a GLB Service to manage DNS queries for the domains being requested.

- Create a Pool of your back-end DNS Servers.
- Create a DNS Virtual Server to listen for DNS requests.

Defining GLB Locations

To view, modify or add new GLB Locations, use the **Catalogs > Locations** page. To modify the name or geographic position for an existing GLB Location, click the location name or the associated **Edit** button.



Your Configuration Locations and GLB Locations are listed separately on this page, with the ability to add to, and remove from, each list individually. For more information on Configuration Locations, see [Multi-Site Cluster Management](#).

To create a new GLB Location

1. Go to **Catalogs > Locations**.
2. In the "Create new GLB Location" section, type an identifying name into the **Name** textbox.
3. For **Type**, select "GLB".



If Multi-Site Cluster Management is disabled, all locations created on this page are of type GLB and this field is not displayed.

4. Click **Add Location** to add this GLB Location and access the location edit page.
5. On the location edit page, choose the **Position** of the GLB Location. Select from either a drop-down list of country names, a specific set of latitude-longitude coordinates, or select a point on the displayed map.
6. Click **Update Location** to save your changes.

To delete a GLB Location, first disassociate it with any GLB Services that are using it. Then click the **Confirm** checkbox and click **Delete Location** to remove it from the system.

Creating a Service Monitor

To configure a Service Monitor for a GLB Location, create a new Pool/GLB Monitor and instruct it to monitor the IP address or hostname of a service hosted at each of your GLB Locations. The monitor type you choose might require additional parameters - see [Health Monitoring](#) for more information.

To create a Service Monitor

1. Navigate to **Catalogs > Monitors**.
2. In the "Create new monitor" section, enter the following:
 - **Name:** The identifying name for this Service Monitor.
 - **Type:** Choose the monitor type that best suits your requirements.
 - **Scope:** Click **Pool/GLB** and enter the IP address or hostname of the service present at the GLB Location you want to monitor. Some monitor types might also require a port number.
3. Click **Create Monitor** to create this Service Monitor and access the edit page.
4. Optionally make any parameter adjustments you need, and click **Update** to save the changes.
5. Repeat this procedure for each GLB Location you want to monitor.

Creating a GLB Service

A GLB Service is based on a set of FQDNs and IP addresses. When you create a new GLB Service, you tell the Traffic Manager which IP addresses are hosted at each GLB Location for each domain name. All of your connected Traffic Managers manage the DNS lookups for each GLB Service.

To create a GLB Service

1. Navigate to **Catalogs > GLB Services**.
2. In the "Create a new GLB service" section, enter the following:
 - **Service Name:** The identifying name for this GLB Service.
 - **Domains:** Enter at least one domain name you want this GLB Service to balance globally. To enter multiple domains, separate the list with a comma or space.
 - **Add locations:** Click one or more pre-defined GLB Locations you want to host the GLB Service. For information on creating GLB Locations, see [Defining GLB Locations](#).
3. Click **Create GLB Service** to create this GLB Service and access the edit page.

For each GLB Service, use the GLB Service edit page to modify its settings. This page shows the basic GLB Service settings, as entered when you created the service, and all other available configuration settings grouped into subpages.

Each new GLB Service you create is added disabled. To enable your GLB Service, set **Enabled** to "Yes".

To add and remove domains that a GLB Service balances, use the **Domains** table. Create an entry here for every FQDN you want to balance globally.

Use "*" to specify a wildcard character. For example, to manage all DNS lookups for any "example.com" domain, type "*.example.com".

Locations and Monitoring

To configure the GLB Locations and Service Monitors attached to this GLB Service, click **Catalogs > GLB Services > Locations and Monitoring**.

The Traffic Manager presents a dedicated configuration subsection for each attached GLB Location. Click **Update** to save any changes you make.

You typically select each GLB Location you want to use when you first create the GLB Service. To add additional GLB Locations, use the "Add Location" section. To remove a GLB Location, locate and click the dedicated **Remove this location** link in the desired GLB Location configuration subsection.



For a newly created GLB Service, the Traffic Manager might show a warning associated with the GLB Locations you selected. This warning exists until you provide suitable Service IP addresses for each GLB Location.

For each attached GLB Location, you can configure the following:

- **Draining:** To stop sending traffic to this GLB Location, set this to "Yes". For example, if you are physically relocating your equipment from one location to another, or if you are upgrading the backup power system and need to disconnect your UPS, generator, inverter and batteries, you can use this option to instruct the Traffic Manager to stop sending traffic to this GLB Location.
- **Service IPs:** In order for the Traffic Manager to manipulate the answers it sends to a client, it must know which IP addresses belong to which GLB Locations. Use this configuration option to enter a list, or a range, of IPv4 addresses or IPv4 CIDR subnets for this GLB Location. These IP addresses correspond to the IP addresses that your DNS servers return using a round-robin mechanism when queried for the domains you are managing.



These IP addresses are typically the same IP addresses you configure in the Service Monitors you assign to this GLB Location.

- **Monitors:** Select which Service Monitors the Traffic Manager should use for this GLB Location. Each monitor performs one test, and you can configure multiple monitors for each GLB Location. You can only select monitors that have a host-wide or pool-wide scope. Monitor tests are performed at configured intervals against a specific target, configured in the Service Monitor. When a monitor has exceeded its limit of consecutive failures, the service in a particular data center is flagged as unavailable. Consequently, this GLB Location is filtered out of any subsequent DNS responses.

Load Balancing

To configure load balancing and failure recovery for this GLB Service, click **Catalogs > GLB Services > Load Balancing**.

The available load balancing methods are:

- **Load:** Distributes traffic based on the detected load at a GLB Location. The Traffic Manager determines load by using health monitors to measure the time it takes to receive a response for a request sent to the GLB Location. In other words, the load value is the measured round-trip time (in milliseconds) for data packets sent to the GLB Location. Whenever a round-trip time of less than 50ms is measured, the Traffic Manager instead uses a load value of 50 to ensure that similarly-local locations are treated equivalently.

You can override this mechanism and influence load balancing decisions by programmatically setting specific load values for each GLB Location. To do this, use either the Traffic Manager's SOAP API or create an external program monitor. Through these methods, the Traffic Manager instead uses the values set when making traffic distribution decisions.

For the *SOAP API method*, use the `GLB.Service.setLoad()` function to declare a load value for each location. To disable the SOAP API and return load reporting to the GLB Location's health monitors, set a load value of 0.

For the *external program monitor method*, create a script or program that calculates the GLB load for a location and outputs this value to stdout using the following format:

```
vTM-Set-node-load: <load-value>
```

where <load-value> is an integer.

Then, add your script or program as an external program monitor to the location.



When using the SOAP API or an external program monitor to set the load to less than 50, the Traffic Manager instead uses a load value of 50. In other words, the behavior is the same as if a round-trip time of less than 50ms had been measured.



Use verbose mode to print your program's stdout output to the Traffic Manager event log.

- **Geographic:** Distributes traffic based solely on the geographic location of each client.
- **Adaptive:** Distributes traffic based on both the current GLB Location load and geographic location of the client. This algorithm might be useful if you find that one of your locations is receiving most of the traffic (to the point where it is being overloaded). In this case, this algorithm can help to achieve the best balance between latency due to distance and latency due to load.
 - **Geo Effect:** Use this option to fine tune how much effect the geographic location has when the Traffic Manager decides which GLB Location it should send a client to.
- **Round Robin:** Distributes traffic based on the sequential selection of each available GLB Location in turn. Over time, all GLB Locations receive an equal number of requests.
- **Weighted Random:** Distributes traffic using a random selection generator, weighted by the setting in **Location Weights**. The Traffic Manager sends more traffic to the GLB Location with the greater weight.
 - **Location Weights:** Set the required proportional weighting for each GLB Location. Over time, a GLB Location receives a number of requests equal to the proportion declared using this setting.
- **Primary/Backup:** The Traffic Manager sends DNS records for one primary GLB Location at any time, resorting only to using a backup GLB Location if the primary GLB Location fails. If you provide a service dependent on state information (such as a shopping cart Web site) and you are not replicating your databases globally in real time, this algorithm can be suitable.

To determine the order of precedence in your list of GLB Locations, use the drag-and-drop tabs to the left of each GLB Location indicator bar. To promote a GLB Location (using a top-down priority order), drag it to the desired place within the stack.

- **Automatic Failback:** Decide what happens when a higher-priority GLB Location recovers after a failure. Click "Yes" to automatically mark the higher-priority GLB Location as active and to instruct the Traffic Manager to direct all users to it. Click "No" to leave the recovered GLB Location as inactive. In this case, the Traffic Manager continues directing users to a currently active GLB Location.
- **Activate best available location:** If **Automatic Failback** is set to "No", click this button to instruct the Traffic Manager to select a new active GLB Location from the list of currently enabled or available GLB Locations.



The **geographic** and **adaptive** load balancing algorithms both require installation of a GeolP database. For more details, see [Using a GeolP Database](#).

To set the failure recovery options for all load balancing algorithms, use the following settings:

- **disable_on_failure:** To ensure recovering GLB Locations do not automatically become enabled, click "Yes". Then, to manually enable a particular disabled GLB Location, click Enable in the desired GLB Location indicator bar. This setting is useful in deployments where the recovered GLB Location needs to synchronize state or content before it can be used.
- **autorecovery:** If all your GLB Locations fail, click "Yes" to instruct the Traffic Manager to automatically enable the last failed GLB Location when it recovers. If you are using the "Primary/Backup" algorithm, your recovered GLB Location is also made active. Click "No" to leave all recovered locations in a disabled state.



The "autorecovery" setting, when enabled, takes precedence over "Automatic Failback" and "disable_on_failure".

- **last_resort_response:** If all GLB Locations connected to this GLB Service become unavailable, the Traffic Manager returns the contents of this setting as a last resort DNS response to any client request. Use either a space separated list of IP addresses, a single domain name, or "ALL" to instruct the Traffic Manager to return all IP addresses received from the DNS server.

DNS Authentication (DNSSEC)

To configure the Domain Name System Security Extensions (DNSSEC) settings for this GLB Service, click **Catalogs > GLB Services > DNS Authentication (DNSSEC)**.

The DNSSEC suite of specifications provides a set of security and authentication extensions to DNS. To enable the Traffic Manager to alter DNSSEC authenticated responses, use this page to set up associations between signature domains and DNSSEC Private Keys.

To add an association

1. Enter a signature domain in the box provided and click the plus symbol.
2. Select a private key to be associated with the domain from the drop-down box.
3. Click **Update** to confirm the association.

You can associate multiple keys to one domain, and you can use an individual key to authenticate many domains (a many-to-many relationship).

To add DNSSEC private keys, click **Manage DNSSEC private keys** to access the **Catalogs > SSL > DNSSEC Keys** page. For more information on importing and uploading SSL Certificates and Keys, see [SSL Encryption](#).

For more information on DNSSEC, see www.dnssec.net.

Rules

To configure TrafficScript rules for this GLB Service, click **Catalogs > GLB Services > Rules**.

You can apply TrafficScript rules to this GLB Service to provide additional traffic management functionality. Note however that you cannot use functions that are incompatible with the DNS protocol (such as http.*). For full details about TrafficScript and its capabilities, see [TrafficScript Rules](#).

Request Logging

To configure request logging for this GLB Service, click **Catalogs > GLB Services > Request Logging**.

In some circumstances, you might want greater visibility of the DNS requests that are flowing into your Traffic Manager cluster. Request logging lets you log each request into a specified file for later analysis.

You can configure the following:

- **log!enabled:** To enable request logging, set to "Yes".
- **log!filename:** The full path and filename on the local file system where the Traffic Manager stores request logs for this GLB Service. Click **Macros...** to see the list of available macros.

- **log!format:** The string format of the request log. You can access information about each request using macros escaped by "%". Click **Macros...** to see the list of available macros.

To view the request logs for your GLB Service, click **View Request Logs in file**.

DNS Settings

To configure the DNS settings for this GLB Service, click **Catalogs > GLB Services > DNS Settings**.

You can configure the following:

- **Time To Live (TTL):** A DNS Server sets a TTL value for each resource record in a DNS response. The TTL value controls how long caching resolvers cache the DNS record before attempting to re-resolve it. GLB services typically require rapid failover in the event of a GLB Location failure and the TTL value set by a DNS server might be too long (for example, several hours or days). To override the TTL for resource records handled by the Traffic Manager, click **Custom** and enter a new value (in seconds).

Creating a DNS Server Pool

For your GLB Virtual Server to perform global load balancing, you need to create a pool containing your DNS Server nodes.

To set up a DNS Server pool

1. Navigate to **Services > Pools**.
2. In the "Create a new Pool" section, add the following fields:
 - **Pool Name:** The identifying name for the new pool.
 - **Nodes:** A list of one or more DNS Server IP addresses or hostnames, with a corresponding port number in the format <host>:<port>. To specify more than one nodes, use a space or comma separator.
 - **Use autoscaling:** Uncheck this box.
 - **Monitor:** Optionally specify a monitor to check the health of your DNS Servers.
3. Click **Create Pool** to create this pool and access the edit page.

Creating a DNS Virtual Server

Your Virtual Server handles incoming DNS requests and passes them on to your back-end DNS Server pool. You associate the GLB Service you created with this Virtual Server.

To create a DNS Virtual Server

1. Navigate to **Services > Virtual Servers**.
2. In the "Create a new Virtual Server" section, enter the following:
 - **Virtual Server Name:** The identifying name for this virtual server.
 - **Protocol:** Select "DNS (UDP)" or "DNS (TCP)" from the drop-down list.
 - **Port:** Choose the incoming port number that this virtual server listens on.
 - **Default Traffic Pool:** Choose the pool containing your DNS Server nodes. For more information, see [Creating a DNS Server Pool](#).
3. Click **Create Virtual Server** to create this virtual server and access the edit page.
4. Click **GLB Services** to access the "Edit GLB Services" page.
5. In the "Add new GLB Service" section, select your required GLB Service from the drop-down list and click **Add Service**. For more information on creating GLB Services, see [Creating a GLB Service](#).
6. To enable your Virtual Server, set **Enabled** to "Yes" on the Virtual Server edit page or click the play icon next to the Virtual Server name on the Traffic Manager home page.

EDNS0 Client Subnet Support

Typically, the Traffic Manager uses the IP address of an incoming DNS request to determine the perceived geographic location of the client when making GLB decisions based on location. However, this IP address might belong to an upstream server or recursive resolver rather than the client it originated from. In many cases, it is safe to assume that the DNS request's IP address is topologically close to the source of the request. However, in some circumstances there might be a significant distance between a client and an upstream resolver, leading the Traffic Manager to make less efficient GLB decisions.

To alleviate this situation, the Traffic Manager supports use of the EDNS0 Client Subnet protocol extension to facilitate identification of the originating client subnet IP address in a DNS request. With this feature enabled, your GLB services use the network address stored in this extension rather than the address from which the DNS request originated.

To enable EDNS0 Client Subnet support, configure your DNS virtual server with **dns!edns_client_subnet** set to "Yes".

For additional information on the EDNS0 Client Subnet option, refer to RFC 7871 (<https://tools.ietf.org/html/rfc7871>).

Traffic Visualization

When GLB is enabled, the Traffic Manager provides additional information into the existing visualization and diagnostic tools in the Admin UI. For example, the World Map provides a real time view of incoming DNS requests and the GLB Location to which the client is subsequently connected (for more information, see [The World Map](#)).

The Current Activity Graph

To see a real time graph of the activity on your system, click **Activity > Current Activity**.

In the "Settings" section, you can plot your data by Traffic Manager or by Configuration Location. Both choices give you option to select all or some of the corresponding Traffic Managers or locations configured on your system, and whether to plot combined or separate results.

With GLB enabled, the Traffic Manager adds two new sets of metrics pertaining to your GLB Services and Locations to the monitor values tree on the **Current Activity > Edit** page.

For more information on the Current Activity graph, see [Key Features in the Traffic Manager Administration Interface](#).

The Historical Activity Graph

The Traffic Manager records the system's activity for the past 90 days. To view this data in graphical form, click **Activity > Historical Activity**. You can see the data plotted on either a linear or logarithmic axes.

In the "Settings" section, you can plot your data by Traffic Manager or by Configuration Location. Both choices give you option to select all or some of the corresponding Traffic Managers or locations configured on your system, and whether to plot aggregate or separate results. You can plot a range of timescales from 1 hour to 90 days.

For more details about the Historical Activity Graph, see [Key Features in the Traffic Manager Administration Interface](#).

The Connections Page

To view information about recent load-balancing decisions the GLB cluster has made, click **Activity > Connections**. For more details about the Connections page, see [Key Features in the Traffic Manager Administration Interface](#).

GLB Request Logs

To view the individual requests handled by each GLB Service, click **Activity > View Logs** and click on the name of the GLB Service want to observe.

You must enable request logging for a GLB Service before the Traffic Manager can start collecting log information. For more details, see [Request Logging](#).

Testing DNS with DIG

"Dig" is the recommended tool for testing and troubleshooting DNS systems. Dig is maintained by Internet Systems Consortium, Inc., who also maintain the Berkley Internet Name Domain (BIND) software. It is open source software and is available for many architectures and operating systems.

If you are a Linux user, depending on which distribution you run, dig is usually either installed with BIND or provided as supplemental package.

See the Internet Systems Consortium's official Web site for further details:

<http://www.isc.org/downloads/bind>

An example usage for Dig:

```
$ dig -t any +norec www.example.com @192.0.2.1
```

In the above example:

- "-t any": requests any type of record (A, NS, CNAME, PTR, and so on).

- "+norec": indicates that the request should be sent with the recursive flag set to "off".
- "www.example.com": the record you are testing.
- "@192.0.2.1": the name server that the request is sent to.

When testing a DNS server or service, it is very important that you always perform non-recursive queries. This ensures that you receive either an authoritative answer or that you know exactly which name servers are authoritative for the domain name you are trying to resolve. You do not receive an answer that the name server you are querying has looked up for you (since you cannot always verify the source of that information).

Using a GeolP Database

Some features of the Traffic Manager require a GeolP database that maps IP addresses to location - longitude and latitude, city, county and country. GLB uses this GeolP database to estimate distances between remote users and local datacenters.

You can access the database directly using the included geo.* TrafficScript and Java functions. For example, to discover the 2-letter country code that a site visitor is accessing from, use the following TrafficScript:

```
$ip = request.getRemoteIP();  
$countryCode = geo.getCountryCode( $ip );
```

Previous versions of the Traffic Manager have included a database derived from MaxMind's GeoLite2 City database in each release. For Traffic Manager version 20.3 onwards, this database must be obtained and downloaded separately. You can download, install, and update the GeolP database using the update package available from the Pulse Secure Technical Support website.

Alternatively, use your own copy of the MaxMind GeoLite2 or GeolP2 database. For more detail on this process, see <https://community.pulsesecure.net/t5/Pulse-Secure-vADC/Updating-the-Pulse-Secure-vTM-GeolP-database/ta-p/35215>.

Installing the Traffic Manager's GeolP Database

Use the steps contained in this section to obtain and install the GeolP package on your Traffic Manager cluster.



This process requires a restart of your Traffic Manager instances. Consider performing these steps at a time of least impact to your services.

To install the GeoIP database:

1. Log in to <https://my.pulsesecure.net> and navigate to **Software Licensing and Download > Pulse License and Download Center > Software Download > Pulse Secure vADC > Pulse Secure Virtual Traffic Manager > Related Software > Accept > Accept**.
2. Select the GeoIP database download package (for example, "geoip_update_20210119.tgz"), click **View Details**, then click **Download**.
3. Download the GeoIP package to your local workstation.
4. Log in to the Admin UI of one of your target Traffic Manager instances and use the **System > Traffic Managers > Upgrade** page to upload the GeoIP package obtained in the previous steps.
5. Select "Upgrade specified traffic managers".
6. Select the Traffic Manager instance you are logged in to.



This method updates Traffic Managers separately to minimize downtime. At this step, if you are satisfied service interruption is not going to impact your users, consider selecting all Traffic Manager instances in the cluster.

7. Click **Upgrade**.

The Traffic Manager applies the GeoIP package and restarts.

8. Check the error log for any problems reported during the upgrade process.
9. Repeat [step 4](#)- [step 8](#) for all other cluster members in turn.

Extending the Traffic Manager's GeoIP Database

The database does not include locations for private IP address ranges (see RFC1918), and other IP address ranges might be missing or inaccurate if they were recently allocated or moved. This section provides information on how you can extend the internal GeoIP database to add or override IP address ranges.

Extensions to the database are stored in the following file `$ZEUSHOME/zxtm/conf/locations.cfg`

Use the following format for each entry, specified as a single line:

```
firstIP lastIP lat lon CC RR city
```

The following rules and definitions apply to each mapping:

- The elements in the line are white-space separated.
- The IP address range is inclusive, and the latitude ("lat") and longitude ("lon") are either "-" or decimal degrees.
- For each location mapping, only firstIP and lastIP are required. All other fields are optional. However, to use the Geographic or Adaptive GLB load balancing algorithms, you must also specify a latitude and longitude.
- The country code ("CC") and region code ("RR") are either "-" or two-letter codes. For example, US TX for Texas. The special files \$ZEUSHOME/zxtm/etc/geo/country_codes.txt and \$ZEUSHOME/zxtm/etc/geo/region_codes.txt provide a full list of the relevant codes.
- The city name can include spaces, for example "San Francisco", but does not specifically have to refer to a city (any descriptive text is acceptable).

Some example mappings:

```
192.168.0.1 192.168.0.128 52.1234 -0.5678 US TX New datacntr
172.16.0.1 172.16.255.255 - - - - Test VPN
99.98.97.96 99.98.97.99
```

Testing the IP Address Mappings

You can test any changes with the following example TrafficScript request rule:

```
$text = "";
# Test your own IP addresses with the whereis function here.
$text .= whereis( "192.168.35.40" ); $text .= "\n";
$text .= whereis( "192.168.199.199" ); $text .= "\n";
$text .= whereis( "17.18.19.20" ); $text .= "\n";

http.sendResponse( "200", "text/plain", $text, "" );

sub whereis( $ip ) {
    return $ip . " is in:\n" .
        "   Country:   " . geo.getCountry( $ip ) . "\n" .
```

```
" CountryCode: " . geo.getCountryCode( $ip ) . "\n" .  
" Region:    " . geo.getRegion( $ip ) . "\n" .  
" City:     " . geo.getCity( $ip ) . "\n" .  
" Long/Lat: " . geo.getLongitude( $ip ) . '/' . geo.getLatitude( $ip ) . "\n";  
}
```

Updating Your Traffic Manager Cluster Configuration

You can edit the `locations.cfg` file directly and the local Traffic Manager configuration system notices the fact that this file has changed and automatically accepts the location mappings defined within it.

However, by editing a configuration file directly in the file system, your Traffic Manager configuration is not automatically replicated out to other cluster members. To manually replicate out the updated configuration, use one of the following methods on the Traffic Manager you just updated:

- Use the replicate option on the **Diagnose > Cluster Diagnosis** page in the Admin UI.
- Execute the `$ZEUSHOME/zxtm/bin/replicate-config` script on the command line.

FIPS Validation in the Traffic Manager

This chapter includes information specific to the Federal Information Processing Standard (FIPS) and provides details about how FIPS can be implemented in the Traffic Manager.

Introduction to FIPS

FIPS is developed by the United States federal government for use in computer systems. If available, and provided you have the required license, the Traffic Manager provides conformity with FIPS through use of a specific operational mode and a third party cryptographic operations module.

ATTENTION

The Traffic Manager is not "FIPS validated". Subject to availability, the Traffic Manager uses a validated cryptographic module for all FIPS operations.

For further information concerning FIPS and how it relates to the Traffic Manager, contact your support provider.

FIPS Mode

The primary feature associated with activating FIPS Mode is that it enables the use of a **FIPS 140-2 Cryptographic Module** when processing traffic. In general, the FIPS Mode feature in the Traffic Manager is to help an organization towards FIPS compliance.

Additionally, various configurations/operations of the Traffic Manager are restricted when FIPS Mode is configured, for two reasons:

1. To ensure inputs to the cryptographic module are within the validated range for FIPS 140-2.
2. To ensure that operations that are mutually exclusive with the requirements for FIPS 140-2 cannot be enabled. An example of a restricted operation is SSL 3.0 (only TLS 1.0 and onward are compatible with FIPS 140-2).

FIPS 140-2

FIPS 140-2 is the second revision of the FIPS 140 series publication, published by the National Institute of Standards and Technology (NIST). This is described in detail at the following location:

<http://csrc.nist.gov/publications/fips/fips140-2/fips1402.pdf>

This document describes the security requirements for cryptographic modules. There are 4 security levels to the FIPS 140-2 requirements, ranging from 1 - 4. It is generally understood that software-only security modules are only capable of achieving the lowest security level (1); higher security levels have requirements, such as tamper protection, that can only be achieved in a physical product. In general these requirements relate to processes involving cryptographic operations.

In addition, several other NIST "Special Publications" should be considered:

- "Guidelines for the Selection, Configuration, and Use of Transport Layer Security (TLS) Implementations" SP 800-52r1 (<http://dx.doi.org/10.6028/NIST.SP.800-52r1>)
- "Transitions: Recommendation for Transitioning the Use of Cryptographic Algorithms and Key Lengths" SP 800-131A (<http://csrc.nist.gov/publications/nistpubs/800-131A/sp800-131A.pdf>):
- For considerations of what constitutes "key strength" SP 800-51 Part 1 (http://csrc.nist.gov/publications/nistpubs/800-57/sp800-57_part1_rev3_general.pdf).



The Traffic Manager does not implement all recommendations made in this document.

FIPS 140-2 and the Traffic Manager

The FIPS 140-2 cryptographic module used in Linux variants of the Traffic Manager is the Riverbed® Cryptographic Security Module (RCSM) (certificate number 2099). Details about the FIPS 140-2 validity of this module can be found at the NIST CMVP page, at:

<http://csrc.nist.gov/groups/STM/cmvp/documents/140-1/1401val2014.htm#2099>

When FIPS Mode is enabled, upon start-up of the Traffic Manager the RCSM will be loaded and initialized. Any failure during initialization (e.g. Power On Self Tests) will be reported as a fatal error - all cryptographic operations in the Traffic Manager FIPS boundary will be disabled (for example, SSL decrypting virtual servers and SSL encrypting pools).

The Traffic Manager FIPS boundary

The Traffic Manager uses cryptography in a number of features, the primary example being for SSL/TLS. However, not all of these cryptographic uses are included within the designated Traffic Manager FIPS boundary shown below:

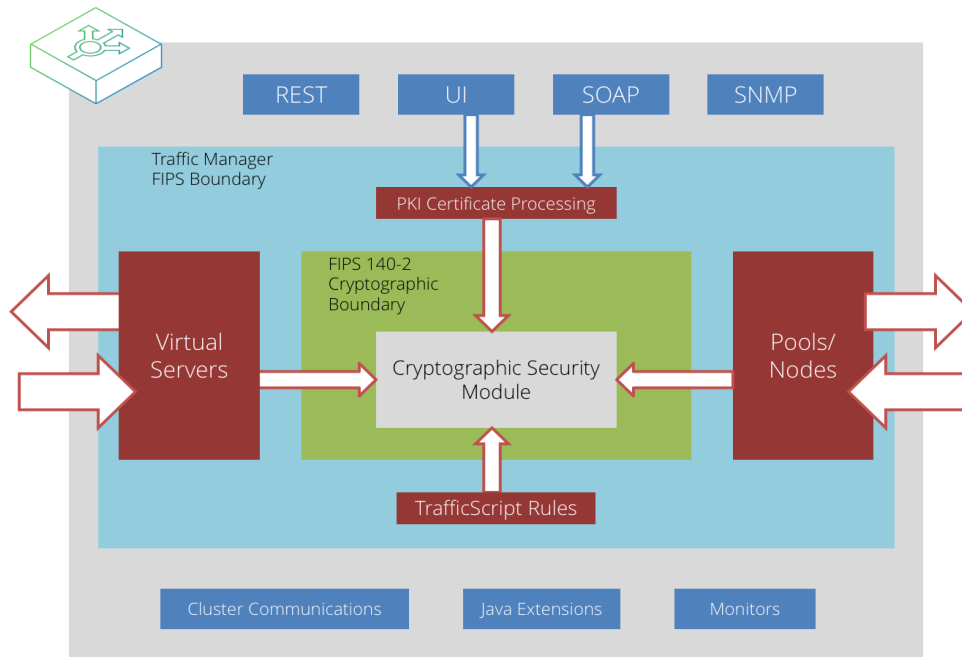

This boundary is most simply defined as:

1. All the cryptographic operations performed for the processing of traffic.
2. All cryptographic interactions with cryptographic objects used when processing traffic.

When FIPS Mode is in operation:

Item (1) covers primarily TLS; all data that is processed by the Traffic Manager in terms of virtual servers and pools will use the FIPS 140-2 cryptographic module for all cryptography. This includes subordinate operations in TLS such as OCSP requests.

Item (2) considers the manipulation of cryptographic objects stored as part of a Traffic Manager configuration, the primary example being PKI certificates and private keys. Any cryptographic interaction with these objects will be performed with the FIPS 140-2 cryptographic module.

All "control-plane" cryptography is not included within the Traffic Manager FIPS boundary. To clarify, the following, non exhaustive, list of functionality is not within the Traffic Manager FIPS boundary:

- Traffic Manager SNMP interaction
- The Traffic Manager SOAP API
- The Traffic Manager REST API
- The Traffic Manager Admin UI

- SSH access to a Traffic Manager Appliance

The importance of (2) in the boundary is that in the case of, for example, the SOAP or Admin UI; although the cryptography used for the transport is not using a FIPS 140-2 cryptographic module, any operations requested that might manipulate cryptographic objects for use within the Traffic Manager FIPS boundary will be performed with a FIPS 140-2 cryptographic module.

When considering whether FIPS Mode is suitable for your deployment requirements, you should ensure that you consider whether the Traffic Manager FIPS boundary provides sufficient functional coverage.

TLS as an exception

As mentioned above, the general definition of the Traffic Manager FIPS boundary is that all cryptographic operations performed within that boundary are done using a FIPS 140-2 cryptographic module.

There is an exception to this, where MD5 is required as part of the TLS 1.0 handshake protocol. Without MD5, it would be impossible to inter-operate with TLS clients requiring only the latest version of TLS. This case is covered by a discussion in the "Guidelines for the Selection and Use of Transport Layer Security (TLS) Implementations" document referenced above, whereby this specific use of MD5 in these very specific parts of the TLS handshake protocol are deemed safe. Refer to this document for further technical details.

As such the Traffic Manager SSL implementation uses an MD5 algorithm from another cryptographic implementation for these specific cases alone, disregarding that MD5 is generally not available from a FIPS 140-2 cryptographic module.

Equally, there are other uses of the MD5 algorithm within the Traffic Manager FIPS boundary, however these have been identified as unrelated to cryptographic or security purposes (i.e. the MD5 algorithm is used as a hash function, rather than as a cryptographic digest).

Deploying FIPS Mode

Preparation

FIPS Mode can only be configured when other certain configuration preconditions have been met. These preconditions are required to provide a suitable environment for using a FIPS 140-2 cryptographic module for processing traffic.

Therefore in preparation for enabling FIPS Mode, the following configuration elements should be inspected and updated accordingly.

Supported SSL/TLS Versions

As per the guidance in SP 800-52r1, only SSL versions TLS 1.0 and later are suitable for operating in an environment using a FIPS 140-2 cryptographic module.

Therefore, to enable FIPS Mode, ensure your Traffic Manager configuration has SSLv3 disabled by setting **ssl!support_ssl3** to "No" on the **System > Global Settings > SSL Configuration** page. Additionally, ensure that your virtual servers and pool do not override the global SSL setting on an individual basis (using the **ssl_support_ssl3** settings on the **Virtual Server > Edit > SSL Decryption** and **Pool > Edit > SSL Encryption** pages).

ATTENTION

If your SSL virtual server clients and pool nodes do not support TLS 1.0 or later, they will no longer be able to connect using SSL.

SSL3 Cipher Suite selection

The FIPS 140-2 requirements provide a list of approved cryptographic methods that a FIPS 140-2 cryptographic module may include. Methods that are not approved are not permitted in the cryptographic module.

Some SSL/TLS cipher suites include cryptographic methods that are not approved by FIPS 140-2, common examples include the RC4 stream cipher and the MD5 digest algorithm. So that all TLS cryptography can be performed using the FIPS 140-2 cryptographic module when in FIPS Mode, the list of cipher suites that can be configured for use with the Traffic Manager is reduced to the following set:

- SSL_ECDHE_ECDSA_WITH_AES_128_GCM_SHA256
- SSL_ECDHE_ECDSA_WITH_AES_128_CBC_SHA256
- SSL_ECDHE_ECDSA_WITH_AES_128_CBC_SHA
- SSL_RSA_WITH_AES_128_GCM_SHA256
- SSL_RSA_WITH_AES_128_CBC_SHA256
- SSL_ECDHE_RSA_WITH_AES_128_GCM_SHA256
- SSL_DHE_RSA_WITH_AES_128_GCM_SHA256

- SSL_ECDHE_RSA_WITH_AES_128_CBC_SHA256
- SSL_DHE_RSA_WITH_AES_128_CBC_SHA256
- SSL_RSA_WITH_AES_128_CBC_SHA
- SSL_ECDHE_RSA_WITH_AES_128_CBC_SHA
- SSL_DHE_RSA_WITH_AES_128_CBC_SHA
- SSL_ECDHE_ECDSA_WITH_AES_256_GCM_SHA384
- SSL_ECDHE_ECDSA_WITH_AES_256_CBC_SHA384
- SSL_ECDHE_ECDSA_WITH_AES_256_CBC_SHA
- SSL_RSA_WITH_AES_256_GCM_SHA384
- SSL_RSA_WITH_AES_256_CBC_SHA256
- SSL_ECDHE_RSA_WITH_AES_256_GCM_SHA384
- SSL_DHE_RSA_WITH_AES_256_GCM_SHA384
- SSL_ECDHE_RSA_WITH_AES_256_CBC_SHA384
- SSL_DHE_RSA_WITH_AES_256_CBC_SHA256
- SSL_RSA_WITH_AES_256_CBC_SHA
- SSL_ECDHE_RSA_WITH_AES_256_CBC_SHA
- SSL_DHE_RSA_WITH_AES_256_CBC_SHA

Additionally, for TLSv1.3:

- TLS_AES_128_GCM_SHA256
- TLS_AES_256_GCM_SHA384

ATTENTION

This will have an impact on interoperability with SSL virtual server clients and pool nodes, if they do not support any of the FIPS 140-2 compatible cipher suites then they will no longer be able to connect via SSL.

TrafficScript Functions

TrafficScript provides access to a number of cryptographic operations for rules executed in the Traffic Manager. When operating in FIPS Mode, these operations will be provided by the FIPS 140-2 cryptographic module.

For TrafficScript functions that use cryptographic methods not approved for FIPS 140-2 cryptographic modules, those functions will not execute successfully when operating in FIPS Mode. It is recommended that you migrate any uses of the TrafficScript functions listed below to an alternative cryptographic digest implementation that is approved for FIPS 140-2 cryptographic modules.

The TrafficScript functions that will produce an error when used in FIPS Mode are those that use the MD5 algorithm:

| Function invalid in FIPS Mode | Suggested replacement |
|------------------------------------|------------------------------------|
| <code>string.hashMD5 ()</code> | <code>string.hashSHA1 ()</code> |
| <code>ssl.serverCertHash ()</code> | <code>ssl.serverCertSHA1 ()</code> |
| <code>ssl.clientCertHash ()</code> | <code>ssl.clientCertSHA1 ()</code> |

PKI Certificates

Public Key Infrastructure certificates and keys are cryptographic assets that need to be considered as part of a FIPS 140-2 deployment.



With FIPS Mode enabled, the Traffic Manager supports the use of RSA or ECDSA public/private keys only. DSA keys are not supported.

Key Strength

Although not directly considered in the FIPS 140-2 document, SP 800-131A covers a set of requirements for acceptable strength of keys used in cryptographic operations. These requirements are generally enforced by a FIPS 140-2 cryptographic module, and so must be considered prior to enabling FIPS Mode. For a more formal discussion about what "key strength" actually is (in this context), see the SP 800-51 Part 1 publication referred to in the FIPS 140-2 section above.

Signature Algorithm

Beyond the strength of a key represented by a certificate, a certificate itself contains a cryptographic signature to enable validation that the certificate is the same as that validated by the issuer.

The algorithms used to create and validate the cryptographic signature must be approved for use in a FIPS 140-2 cryptographic module when in FIPS Mode. In FIPS Mode only those certificates whose signature digest uses the FIPS-approved SHA-1, SHA256, SHA384 and SHA512 algorithms can be used.

Traffic Manager SSL Configuration

Prior to enabling FIPS Mode, the Traffic Manager SSL catalog (found at **Catalogs > SSL**) should be audited for:

- Certificates and keys that have a modulus value that is less than 1024 bits, and;
- Certificates that have a signature using a non-approved digest algorithm, typically MD2 and MD5.

If you attempt to enable FIPS Mode in this way, validation errors will highlight any certificates in the current configuration that will prevent the operation from succeeding.

Alternatively, you can use the command-line "cert" tool included in your Traffic Manager installation to evaluate individual certificates. For example, to inspect the SSL Server Certificate 'example' certificate file, use the following command:

```
$ZEUSHOME/admin/bin/cert --format text \  
--in $ZEUSHOME/zxtm/conf/ssl/server_keys/example.public
```

Once these "weak assets" have been identified, you should evaluate their purpose in your Traffic Manager deployment to determine whether they are actually required, and if they are what other systems/services need to be changed/updated/deprecated to successfully move your Traffic Manager deployment towards having FIPS Mode enabled. These "weak assets" must be removed before FIPS Mode can be enabled.

ATTENTION

Removing certificates and private keys may have an impact on connectivity with your Traffic Manager deployment. For example, SSL clients may be required to present a certificate signed by a "weak" CA, or the Traffic Manager itself may be required to provide a specific certificate when connecting by SSL to nodes in a pool. In these example cases, removing the "weak assets" will prevent clients, and the Traffic Manager, from creating SSL connections.

Deployment Considerations

In addition to the above, you should consider your deployment where the Traffic Manager is in operation.

When operating in FIPS Mode, the Traffic Manager will reject requests to process cryptographic "weak assets" regardless of whether they are from the local configuration or received from remote systems.

ATTENTION

If you are expecting virtual server clients to present certificates when connecting to the Traffic Manager by SSL, or the Traffic Manager is connecting to pool nodes by SSL, you should ensure the certificates presented by virtual server clients and pool nodes are suitable for operations in FIPS Mode.

Certificate Chains

When operating with chains of certificates, all the certificates in the chain must not be "weak" in order for that certificate chain to be successfully used by the Traffic Manager in FIPS Mode.

Key Exchange Strength

Some cipher suites make use of the Diffie-Hellman Key Exchange algorithm. SP 800-131A covers a set of requirements for acceptable strength of keys, which is also applicable for the Diffie-Hellman algorithm.

The size of the modulus in the domain parameters for finite field Diffie-Hellman key agreement used by the Traffic Manager can be configured with the `ssl!diffie_hellman_modulus_size` configuration key (from the "SSL Configuration" section of the **System > Global Settings** page).

Ensuring / Retaining Validity

The validity of a FIPS 140-2 cryptographic module is defined by the testing performed by an accredited testing laboratory. Testing for a software cryptographic module is performed on a specific hardware/operating system platform (operational environment). When a FIPS 140-2 cryptographic module is used in an operational environment where it has been validated, that module can be considered FIPS 140-2 validated.

The details about the operational environments in which the RSCM has been validated can be found in its listing on the NIST Web site.

While testing has been performed on a limited number of operational environments (and thus the RCSM used in those environments have explicit FIPS 140-2 validity), it is understood that a validated FIPS 140-2 cryptographic module (Level 1) may retain its validity when operating in an environment where it has not been explicitly validated (for FIPS 140-2).

The Implementation Guidance for FIPS 140-2

(<http://csrc.nist.gov/groups/STM/cmvp/documents/fips140-2/FIPS1402IG.pdf>) covers this case under section G.5. This covers the "porting" rules that a vendor (Riverbed in the case of the RCSM) or a user, for example, an administrator for a Traffic Manager installation, should conform to in order to retain FIPS 140-2 validity on a platform that has not been explicitly listed as validated. Note that NIST (specifically CVMP) remains the overall arbitrator of whether a FIPS 140-2 cryptographic module is and is not considered valid.

ATTENTION

If you are concerned about whether or not the Traffic Manager will retain the FIPS 140-2 validity of the RCSM in your installation, please contact your support provider.

Non-Linux Operating Systems

The RCSM has only been tested for validation on versions of the Linux Operating System. Support and validation for non-Linux systems is not available.

Enabling FIPS Mode

Providing you have followed the preceding instructions for preparing your Traffic Manager deployment, you can enable FIPS Mode by accessing the **System > Global Settings** page of the Admin UI and setting the **fips!enabled** configuration key to "Yes".



fips!enabled is a cluster-wide setting that cannot vary by location.

Restart Traffic Managers

Setting the **fips!enabled** key in your configuration is not sufficient to have the Traffic Manager operate fully in FIPS Mode; a restart of each Traffic Manager instance in the cluster is required.

ATTENTION

Restarting the Traffic Manager disconnects any active connections. For high availability deployments, Ivanti recommends that you schedule this operation to minimize the interruption to your services. For further information, see the *Pulse Secure Virtual Traffic Manager: Installation and Getting Started Guide* applicable to your product variant.

Validation

When using the Admin UI or SOAP-based Control API after enabling FIPS Mode, the Traffic Manager will perform a validation of your configuration to ensure various criteria for FIPS Mode.

Any aspect of the configuration that is in conflict with FIPS Mode will generate an error. If you see such an error, please refer to the Preparation section above with respect to the error you observe.

Operating in FIPS Mode

When operating in FIPS Mode, each Traffic Manager in a cluster will report whether it is successfully operating in FIPS Mode in the event log. A message such as the following can be seen:

```
FIPS 140-2 Cryptographic module loaded: FIPS Mode in operation
```

FIPS Mode Errors

If there is an error when trying to enable FIPS Mode, the Traffic Manager will report this in the event log. In the Traffic Manager component where FIPS Mode failed, cryptographic operations (and services that utilize those operations) will be disabled within that component.

As an example, consider a Traffic Manager with two HTTP virtual servers, one with SSL decryption and one without. If FIPS Mode fails to successfully initialize, the SSL decrypting virtual server will be disabled and no traffic will be processed, the other virtual server will operate normally.

ATTENTION

Even if a Traffic Manager is successfully started with FIPS Mode in operation, it is possible, although rare, that during operation the requirements for FIPS 140-2 will cease to be met. In these cases, the same behavior as encountered during an initialization failure can be expected: the failing Traffic Manager will report an error, and cryptographic operations will no longer be available where FIPS Mode has failed.

Kerberos Constrained Delegation Support

This chapter discusses the Traffic Manager's support for Kerberos Constrained Delegation.

The Kerberos Protocol

The Kerberos protocol allows entities (known as "principals") to authenticate with each other through the commonly understood and trusted Key Distribution Center (KDC) service. The KDC for a realm authenticates principals associated with that realm by verifying credentials provided by the principal. It can subsequently generate tickets that the principals operating in a realm can exchange in order to establish authenticated peer-to-peer exchanges of information. A ticket issued for a user to a principal by the KDC contains identity data for the user encrypted using a secret shared only by the principal and the KDC.



Microsoft® implementations of the Kerberos protocol refer to the realm as a "domain", and to the KDC service as the "domain controller".

Kerberos Protocol Transition and Constrained Delegation

Where clients have direct access to the KDC for the realm their principal is a part of, Kerberos authentication between "Kerberized" applications operates normally. However, where direct access to the KDC is not possible, a user cannot always access services that require the exchange of Kerberos tickets for authentication. For example, a laptop computer solely connected to the public Internet might not have direct access to the laptop user's KDC due to firewall rules. To address this, two extensions to the Kerberos protocol are available: Protocol Transition and Constrained Delegation.

Protocol Transition

This mechanism allows a suitably privileged Kerberos service to obtain a ticket to itself for an arbitrary user principal in a given realm. The KDC expects the service to perform authentication through some other means to confirm the identity of a user before then establishing a ticket for the user in the Kerberos protocol. In other words, the service provides a transition from one authentication protocol to Kerberos.

Constrained Delegation

Since the service providing the protocol transition should have already satisfied itself that the user is who they claim to be, having a ticket for an arbitrary user principal to itself is of limited use. Through constrained delegation, the service can delegate the ticket for itself to another service, meaning that this ticket can be forwarded on by the service (with a request associated with the original user) to a further Kerberized service. This new service then processes the request in the context of the original user.

Arbitrarily being able to impersonate any user in a realm could be considered too much power for a service, but the "constrained" aspect of the feature allows the KDC to impose a restriction on which service the ticket might be delegated to.

Rationale for Using Kerberos

In the context of the Traffic Manager, Kerberos Protocol Transition can be useful where the Traffic Manager sits on the border of your internal network, providing access to internal services. The internal services on a corporate LAN that authenticate using Kerberos can be made available over a more public network where access to the KDC is not permitted. The Traffic Manager uses alternate means to identify the principal name of the user and perform protocol transition.

The Traffic Manager supports protocol transition from TLS client certificate-based authentication.

Configuring Kerberos on the Traffic Manager

The Traffic Manager's Kerberos support allows it to authenticate a user through a TLS client certificate. The Traffic Manager communicates with a realm's KDC using its own service principal and acquires a ticket to a service running on a back-end node on behalf of a client making a request on a virtual server.

Traffic Manager Service Principal

To participate in the Kerberos realm, the Traffic Manager must have a suitably privileged principal with which to identify itself. You must ensure your identity management system and associated KDC configuration has a Kerberos principal for the Traffic Manager, and is configured to allow protocol transition and constrained delegation to the services the Traffic Manager is managing.

For each Traffic Manager within the cluster, the KDC administrator must configure the KDC to allow the Traffic Manager's service principal to delegate to other services, and the service principal name must match the name used by the Traffic Manager. This is a string in the form:

<service>/<Traffic Manager hostname>@<REALM>

In this string, use the <service> and <REALM> values from the Kerberos Principal record you want to use from your Kerberos Principals catalog.

For example, if the hostname of the Traffic Manager is "stm1.example.com", and a connection uses a Kerberos Principal record with service name "HTTP" and realm "EXAMPLE.COM", the KDC must trust the principal named "HTTP/stm1.example.com@EXAMPLE.COM" for delegation to your end services.

For Microsoft implementations, this means that you have created a computer account for the Traffic Managers on the domain, have configured a server principal name for the relevant services on the Traffic Managers, and have permitted delegation for those services to the Traffic Managers.

For a Traffic Manager to authenticate itself as the created principal, you must specify the appropriate credentials. For user principals, you specify your credentials in the form of password entry. Since interactive password entry is not convenient for service principals, you must instead use a "Keytab" file for the credentials of your Traffic Manager Service Principals. A Keytab file can contain credentials for one or more principals.

To configure the Traffic Manager to perform protocol transition in a Kerberos realm, upload a Keytab file containing the credentials for all Traffic Managers in the cluster, and configure a Kerberos Principal to use the Keytab file.

Your Keytab files are stored in the Traffic Manager Keytab catalog. To upload Keytab files to the catalog, use the **Catalog > Kerberos > Kerberos Keytabs** page in the Admin UI.

Catalogs: [Locations](#) [DNS Server](#) [GLB Services](#) [Rules](#) [Java](#) [Web Accelerator](#) [Monitors](#) [SSL](#) [Authenticators](#)

[Kerberos > Kerberos Keytabs](#) [SAML](#) [Protection](#) [Persistence](#) [Bandwidth](#) [SLM](#) [Rate](#) [Cloud Credentials](#) [Extra Files](#)

Kerberos Keytab Files

Kerberos keytab files for authenticating configured Kerberos principals.

| Name | Size | Select (all / none) |
|--|---------|--------------------------|
| krbtabfile <input type="button" value="Rename"/> | 9 bytes | <input type="checkbox"/> |
| krbtabfile-2 <input type="button" value="Rename"/> | 9 bytes | <input type="checkbox"/> |

Confirm operation

Upload Kerberos Keytab File

Upload a file to the keytabs directory.

File: No file chosen

To create a Kerberos principal catalog item, use the **Catalog > Kerberos > Kerberos Principals** page of the Admin UI. For each principal, specify the following fields:

| Configuration Item | Description |
|--------------------|---|
| name | The identifying name of the Principal configuration. |
| service | The service name aspect of the Kerberos Principal name that the Traffic Manager uses to authenticate itself. |
| keytab | The name of the Keytab file in the Kerberos Keytabs catalog that contains the credentials for this principal. |
| realm | The realm the Kerberos principal is a part of. |
| kdc | An optional list of <host>:<port> pairs to explicitly specify the KDC services to use for the realm. If you do not specify a list, the Traffic Manager uses DNS to determine the KDCs that should instead be used. |
| krb5conf | The name of a predefined Kerberos configuration file to use with this Principal (optional). To use a Kerberos configuration file, you must first upload it using the Catalog > Kerberos > Kerberos Configuration Files page of the Admin UI. |

Virtual Server Protocol Transition Configuration

To use Kerberos Protocol Transition with your virtual server, use the **Virtual Servers > Edit > Kerberos Protocol Transition** page.

Configuring: **Traffic IP Groups** **Virtual Servers > Web Traffic > Kerberos Protocol Transition** **Pools** **Config Summary**

Kerberos Protocol Transition

Virtual Server: Web Traffic (HTTP, port 80)

Kerberos Protocol Transition allows clients to use services that use Kerberos authentication without having Kerberos tickets themselves.

Kerberos Protocol Transition settings

These settings control Kerberos Protocol Transition for this virtual server.

Whether or not the virtual server should use Kerberos Protocol Transition.
kerberos_protocol_transition!enabled: Yes No

The Kerberos principal this virtual server should use to perform Kerberos Protocol Transition.

| | Name | |
|--|---|-------------|
| kerberos_protocol_transition!principal: | <input checked="" type="radio"/> <i>Not specified</i> | |
| | <input type="radio"/> KCDP1 | Edit |
| | <input type="radio"/> KCDP2 | Edit |

The Kerberos principal name of the service this virtual server targets.
kerberos_protocol_transition!target:

Apply Changes

To enable Kerberos, set **kerberos_protocol_transition!enabled** to Yes. Using this page, you can optionally configure a Kerberos Principal and the principal name for a target service the virtual server is handling.



For protocol transition to be successful, you must configure both a Traffic Manager and a target principal. Configure these settings in either a virtual server or a pool.

The Traffic Manager must acquire the client principal from a client SSL certificate. To enable this, configure your virtual server with **ssl_decrypt** enabled along with **require_cert** to ensure a client certificate is solicited from the client. To ensure the client is properly authenticated, configure your virtual server with appropriate certificate authorities and OCSP settings.

Pool Protocol Transition Configuration

You can also configure Kerberos Protocol Transition using the **Pool > Edit > Kerberos Protocol Transition** page.

Configuring: **Traffic IP Groups** **Virtual Servers** **Pools > Web Traffic > Kerberos Protocol Transition** **Config Summary**

Kerberos Protocol Transition

Pool: Web Traffic

Kerberos Protocol Transition allows clients to use services that use Kerberos authentication without having Kerberos tickets themselves.

Kerberos Protocol Transition settings

These settings control Kerberos Protocol Transition for this pool.

The Kerberos principal the traffic manager should use when performing Kerberos Protocol Transition.

| | Name | |
|--|---|-------------|
| kerberos_protocol_transition!principal: | <input checked="" type="radio"/> <i>Not specified</i> | |
| | <input type="radio"/> KCDP1 | Edit |
| | <input type="radio"/> KCDP2 | Edit |

The Kerberos principal name of the service this pool targets.

kerberos_protocol_transition!target:

Apply Changes

If you specify a principal or target here, this configuration overrides any Kerberos configuration present in a virtual server that uses this pool.

Load-Balancing a Pulse Connect Secure Service

This chapter describes how to configure the Traffic Manager to load-balance VPN connections to a Pulse Connect Secure (PCS) service. It also describes how to configure the Traffic Manager to provide optimal gateway selection and dynamic failover when deploying multiple geographically-located PCS clusters.

Overview of a PCS Load Balancing Configuration

You can configure the Traffic Manager to distribute incoming user VPN sessions across a set of PCS instances. The Traffic Manager additionally monitors the health of your PCS instances, and provides load-balancing and failover functionality across your PCS deployment.

To simplify operation, the Traffic Manager provides a wizard - "Load-balance Pulse Connect Secure"- that automatically creates Traffic Manager service configuration based on the details that you provide.

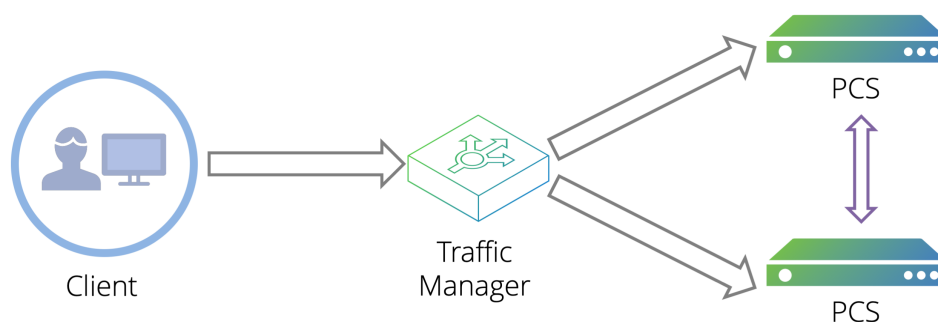

ATTENTION

The wizard does not perform any configuration outside of the Traffic Manager. Before running the wizard, make sure you have a fully-configured set of PCS instances. These instances might be clustered in an active/active configuration, or might share configuration through some other means. For more information, see the Pulse Connect Secure documentation available from the Ivanti website (www.ivanti.com).

To use the wizard, make sure you have the following information:

- An identifying name for the new service.

- A previously-created Traffic IP group containing all IP addresses that the new service should listen on.
- The UDP port number you want the Traffic Manager to use (where ESP mode is configured on your PCS instances).

i Images and references in this guide assume the default value of 4500.

- The hostnames or IP addresses of your PCS instances.

In addition, decide whether you want the Traffic Manager to perform the following functions:

- Redirect HTTP requests to HTTPS.
- Use IP transparency.

i Before you run the wizard, make sure you do not have any existing services using port 443 or the selected UDP port on the Traffic IP addresses you want to use.

Topology of a PCS Load Balancing Configuration

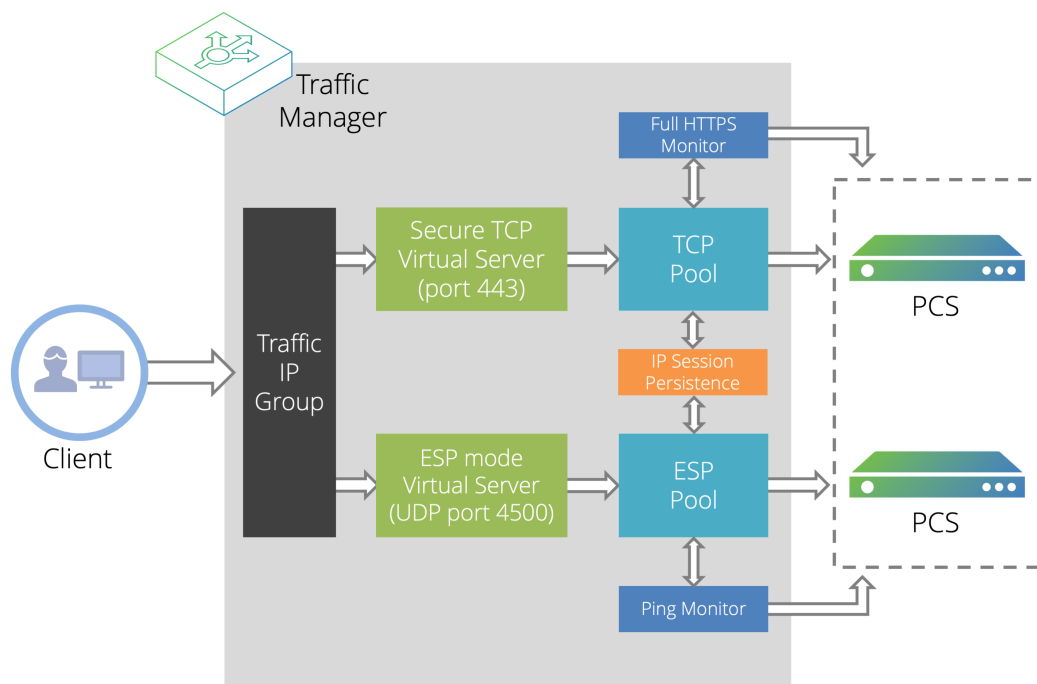

The Traffic Manager hosts the published VPN service using one or more Traffic IP addresses, typically within a Traffic IP group. When a client attempts to establish a VPN session, it starts by creating a secure TCP control connection. After authenticating over this connection, the client then attempts to send ESP traffic over a secure UDP channel. As such, the wizard configures the Traffic Manager to receive both types of traffic using a pair of services, one for secure TCP traffic and another for UDP streaming traffic. The Traffic Manager maintains a separate pool for each protocol type, each pool containing the same PCS instances as nodes. This way, the Traffic Manager can load-balance both TCP and UDP connections originating from the same client to the same PCS instance.

In the event that a secure UDP channel cannot be established between the client and the PCS server, the client falls back to using the TCP connection for the VPN traffic.

To ensure that VPN traffic is sent to the same PCS instance that is handling the corresponding control connection, the wizard configures and applies IP-based session persistence across both pools.

Finally, to ensure the Traffic Manager can perform effective load-balancing decisions, the wizard configures both pools with suitable health monitoring.

Running the Load-balance a Pulse Connect Secure Wizard

To run the wizard, click the “Wizards” drop-down menu in the tool bar, then select “Load-balance Pulse Connect Secure”.

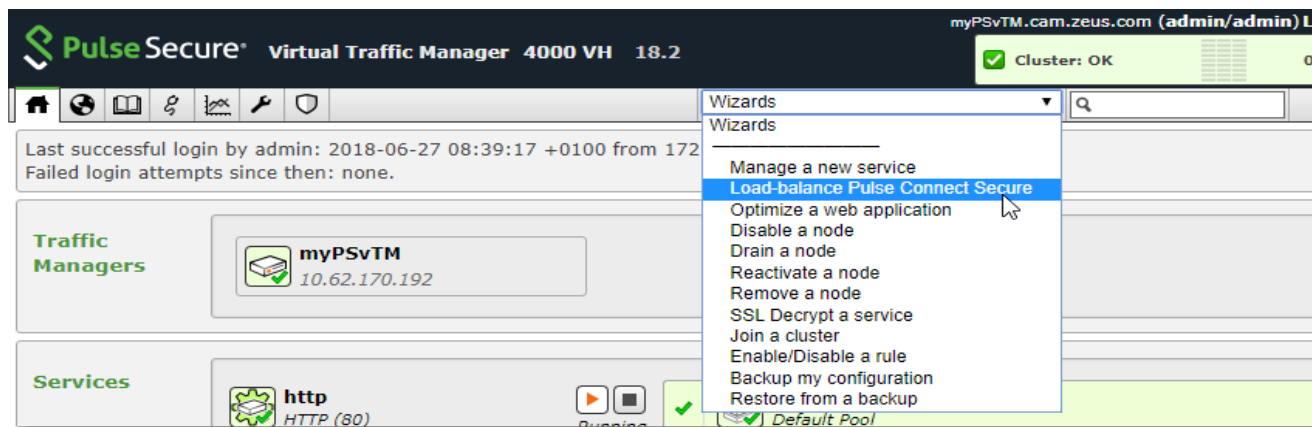

The Traffic Manager displays the first page of the wizard.

Load-balance Pulse Connect Secure, step 1 of 8

1. Load-balance Pulse Connect Secure

This wizard will guide you through the process of configuring the traffic manager to load-balance VPN connections to a Pulse Connect Secure service.

The wizard requires you to input a hostname or IP address for each Pulse Connect Secure instance.

If the service is to listen on a Traffic IP address, then an appropriate Traffic IP group should be created before commencing this wizard.



Cancel ◀ Back Next ▶

Click **Next** to continue.



On each wizard page, use **Cancel** to cancel the wizard without making any changes to the Traffic Manager. Use **Back** to return to the previous page and **Next** to continue on to the next page.

Load-balance Pulse Connect Secure, step 2 of 8**2. Name service**

Enter a name to identify the service that is to be load-balanced. All configuration created by this wizard will be prefixed with the name entered here.

Name:

The Traffic Manager uses the identifier you provide here as a prefix for all configuration objects it creates through this process.

Type an identifying name and click **Next** to continue.

Load-balance Pulse Connect Secure, step 3 of 8**3. Listen on address**

Select on which IP addresses or Traffic IP groups the service should listen:

- All IP addresses
- Traffic IP Groups ...

Use this page to determine if you want your VPN service to listen on all IP addresses hosted by the Traffic Manager, or to instead use a previously-defined Traffic IP group.

IP addresses assigned to the front-end network interfaces on your Traffic Managers might not be suitable to use when you publish your VPN service. In the event of a hardware or system failure in your Traffic Manager cluster, your services would become partially or wholly unavailable.

The Traffic Manager's fault tolerance capability allows you to configure *Traffic IP addresses*. These IP addresses are not tied to individual Traffic Manager instances, and the cluster ensures that each IP address is fully available, even if some of the Traffic Manager instances have failed.

Traffic IP addresses are arranged into a Traffic IP group. You define the group as spanning some or all of your Traffic Manager instances. Group members negotiate between themselves to share out the Traffic IP addresses, and each Traffic Manager then raises the IP address (or IP addresses) allocated to it. To learn more about Traffic IP addresses and groups, see [Traffic IP Groups and Fault Tolerance](#).

Select an option from the list and click **Next** to continue.

Load-balance Pulse Connect Secure, step 4 of 8

4. ESP Mode

If your PCS instances are configured to support ESP mode, PCS clients will attempt to send VPN traffic over a separate UDP channel. Configure this port to match the UDP port setting on the PCS instances.

UDP Port:

The Traffic Manager uses the value you specify here to configure the ESP mode UDP streaming virtual server. Make sure the port number you specify matches the UDP port setting on your PCS instances.

Load-balance Pulse Connect Secure, step 5 of 8**5. Redirect HTTP to HTTPS**

Specify whether the traffic manager should redirect HTTP requests to HTTPS. If enabled, users attempting to connect to PCS over HTTP will be redirected to the secure endpoint.

HTTP Redirect: Yes
 No

Cancel ◀ Back Next ▶

Use this setting to configure the Traffic Manager to ensure requests sent over HTTP are redirected to a secure HTTPS endpoint. Ivanti recommends consulting the network security policies of your organization before enabling this option.

Click **Next** to continue.

Load-balance Pulse Connect Secure, step 6 of 8**6. Pulse Connect Secure instance addresses**

Enter the hostnames or IP addresses of the PCS instances:

Hostname:

PCS instances:

To remove an address from the list, select it and press 'Remove PCS instance':

Cancel ◀ Back Next ▶

Use this page to add your PCS cluster to the Traffic Manager. For each cluster member, type the hostname or IP address into the **Hostname** field and click **Add PCS instance** to add it to the list. To remove a PCS instance, select the corresponding list entry and click **Remove PCS instance**.

Click **Next** to continue.

Load-balance Pulse Connect Secure, step 7 of 8

7. Pool IP Transparency

Specify whether connections from the traffic manager to the PCS instances should appear to originate from the original client's source IP address.

Note that if IP transparency is enabled, your PCS instances must be configured to route return traffic to the traffic manager cluster. See the Network Layouts section of the **User's Guide** for details on how to configure the traffic manager and PCS instances to enable traffic to be routed correctly when IP transparency is enabled.

IP Transparency: Yes No

Through a traditional load-balancing deployment, the Traffic Manager listens for incoming connections and balances them across your PCS instances. A PCS instance sees the incoming traffic as having originated from the Traffic Manager's back-end IP address, and so sends a response back to the same address. The Traffic Manager then passes this response back to the client.

In some circumstances, you might want to propagate the client IP address through to the PCS instance, such that PCS observes the connection as having originated from the client's own IP address rather than the IP address of the Traffic Manager. This is known as *IP transparency*.

To enable IP transparency on the VPN service, set **IP transparency** to "Yes".

ATTENTION

With IP transparency enabled, PCS addresses its responses back to the IP address of the client that sent the request. However, for transparency to operate correctly, each PCS instance must route its responses back through the Traffic Manager that sent the request. Therefore, you must configure your PCS instances to use the Traffic Manager as the default gateway. To learn more about traffic routing with IP transparency, see [Essentials of Network Configuration](#).

For details of how to configure PCS, see the documentation available on the Ivanti website (www.ivanti.com).

Click **Next** to continue.

Load-balance Pulse Connect Secure, step 8 of 8

8. Summary

The following configuration will be created to load-balance Pulse Connect Secure:

Virtual servers:

| | |
|-----------------------|---------------------|
| HTTPS Virtual Server: | Cambridge_pcs_https |
| HTTPS Port: | 443 |
| ESP Virtual Server: | Cambridge_pcs_esp |
| ESP Port: | 4500 |
| HTTP Virtual Server: | Cambridge_pcs_http |
| HTTP Port: | 80 |
| Listening on: | All IP addresses |

Pools:

| | |
|-------------------|-----------------------------------|
| HTTPS Pool: | Cambridge_pcs_https |
| HTTPS Pool Nodes: | 192.0.2.0:443, 192.0.2.1:443 |
| ESP Pool: | Cambridge_pcs_esp |
| ESP Pool Nodes: | 192.0.2.0:4500, 192.0.2.1:4500 |

Using IP Transparency: Yes

Node health monitors:

| | |
|----------------|---------------------|
| HTTPS Monitor: | Cambridge_pcs_https |
| ESP Monitor: | Cambridge_pcs_ping |

HTTP Redirect:

| | |
|----------|------------------------|
| Enabled: | Yes |
| Rule: | Cambridge_pcs_redirect |

Session persistence:

| | |
|--------------------|------------------|
| Persistence class: | Cambridge_pcs_ip |
|--------------------|------------------|

To create this service, press 'Finish'. To change your settings, press 'Back'.

Cancel ◀ Back Finish

This page displays a summary of the proposed Traffic Manager settings. Click **Cancel** to quit the wizard without making any changes, click **Back** to return to the previous page, or click **Finish** to complete the wizard and configure the Traffic Manager.

After the wizard has completed all configuration, the Traffic Manager Home Page is updated to show all running services.

Weighted Load Balancing with Service Discovery

For Pulse Connect Secure release 9.1R3 and later, the Traffic Manager can optionally use Service Discovery to query the number of free license seats on each PCS instance in your deployment. The Traffic Manager can then use this information with weighted load balancing to avoid over-provisioning a single PCS instance.

The Traffic Manager uses the PCS *healthcheck* API to discover the number of free license seats, and in turn to bias new connections to devices that report they have a greater license capacity.

To use this feature, first make sure your PCS instances are configured to accept healthcheck requests from your Traffic Manager's back-end IP address. For details, see the Pulse Connect Secure documentation on the Ivanti Technical Publications website (<https://www.ivanti.com/support/product-documentation>).

To start using the healthcheck API, reconfigure your PCS pools in the Traffic Manager Admin UI to use the built-in Service Discovery plug-in. Select the Service Discovery sub-section (click **Services > Pools > Edit > Service Discovery**) and complete the following required configuration items:

| Configuration Item | Setting |
|-------------------------------|---|
| service_discovery!enabled | Set to "Yes" |
| service_discovery!plugin | Select "builtin-PCS_PPS" |
| service_discovery!plugin_args | <p>For the HTTPS pool, use the following argument:</p> <pre>--nodes="192.0.2.0:443 192.0.2.1:443" --info</pre> <p>For the ESP pool, use the following argument:</p> <pre>--nodes="192.0.2.0:4500 192.0.2.1:4500" --info</pre> <p>For the --nodes argument, substitute in a space or comma separated list of your PCS node IP addresses, as also specified during the "Load-balance Pulse Connect Secure" wizard .</p> |

| Configuration Item | Setting |
|--------------------|--|
| | <p>The --info argument places INFO messages in the Traffic Manager Event Log whenever a change is detected in the relative node weights (used by the load-balancing algorithm). If such log message are not required, you can safely omit this argument.</p> <p>For the ESP pool, make sure the port number you use matches that specified during the "Load-balance Pulse Connect Secure" wizard .</p> |

To save your changes, click **Update**. Note that in the pool edit page, the node list is no longer configurable.

Next, select a "Weighted" load-balancing algorithm (click **Services > Pools > Edit > Load Balancing**). You must complete this process for both PCS pools in your Traffic Manager configuration.

To learn more about Service Discovery, see [Service Discovery](#).

Using the Traffic Manager to Provide Optimal Gateway Selection

An organization can deploy multiple instances of PCS across a series of global data center locations to provide secure remote access facilities to users local to that region. Each location might contain a single PCS device, or possibly a cluster of PCS devices to ensure VPN service availability in the event of a single device failure. However, in the event of regional disruption, total service loss is possible.

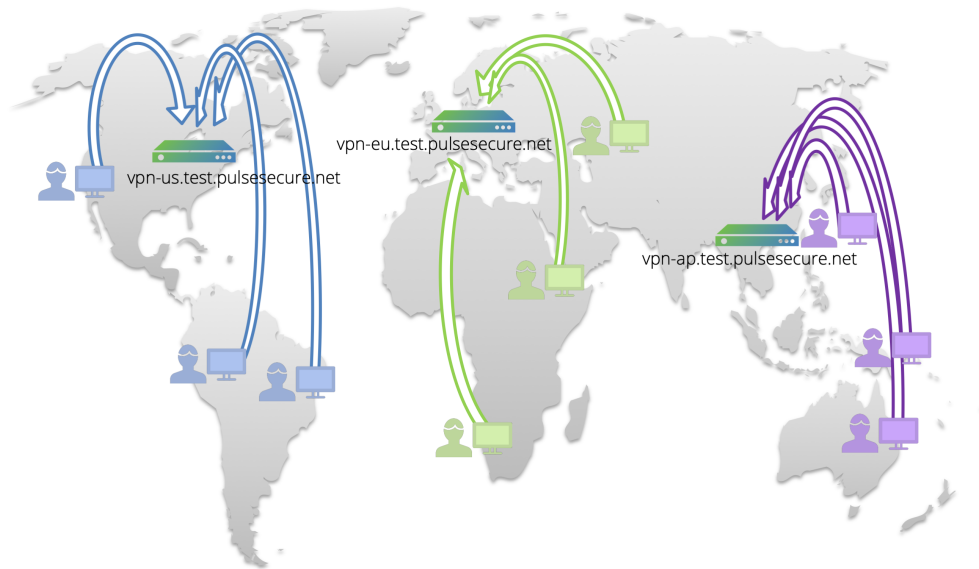

Furthermore, users must manually determine the optimal PCS gateway for their needs at any given geographic location. Configuration and URL settings for all locations must be maintained across all users and all devices.

If complete failure occurs at any one location, user or admin intervention is required to force failover to an alternate PCS gateway in another location.

To alleviate this problem, the Traffic Manager provides a wizard - "Optimal Gateway Selection" - that configures a single, unified, enterprise-wide endpoint URL for your globally-distributed PCS gateway services. The Traffic Manager uses DNS-based Global Server Load Balancing (GSLB) to provide optimum gateway selection and dynamic failover based on a series of observed criteria:

- The geographic location of the user relative to the nearest available PCS gateway
- The current availability of the selected PCS gateway
- The measured load on the selected PCS gateway



To provide the GSLB function, you must use the Traffic Manager as an authoritative DNS server. The Optimal Gateway Selection wizard does not support use of a separate back-end DNS service.

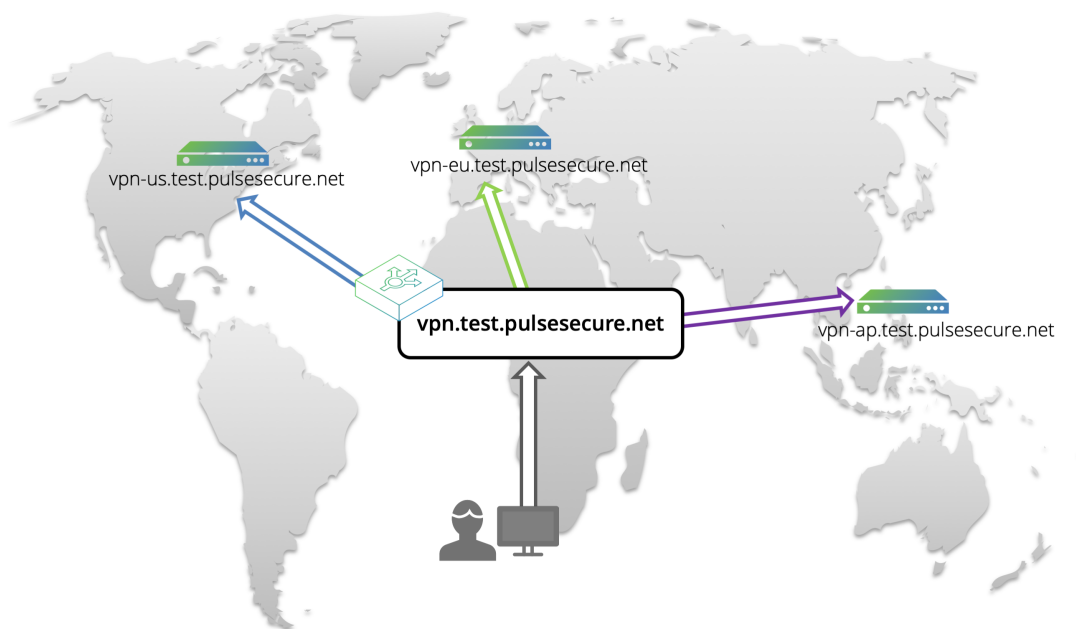

When the Traffic Manager receives a DNS request from a client for the unified endpoint URL, the Traffic Manager adds location-awareness to the DNS lookup, such that the result of the lookup becomes dependent upon its source. It determines and modifies the response, based on configurable metrics (such as geographic proximity and load), before sending the response back to the client.

The Traffic Manager continually monitors the health of all PCS service locations, and automatically redirects users to a working location in the event of service failure.

Making changes to your PCS infrastructure later, such as replacing one location with another, requires an update only to your Traffic Manager configuration. All users continue to use the unified endpoint URL, with no client configuration updates required.

Using the Optimal Gateway Selection Wizard

The Traffic Manager includes a wizard that gathers details about your globally distributed PCS infrastructure and requirements for a unified VPN endpoint. The wizard configures the required settings in the Traffic Manager to create a fully functioning GSLB service based on the following topology.

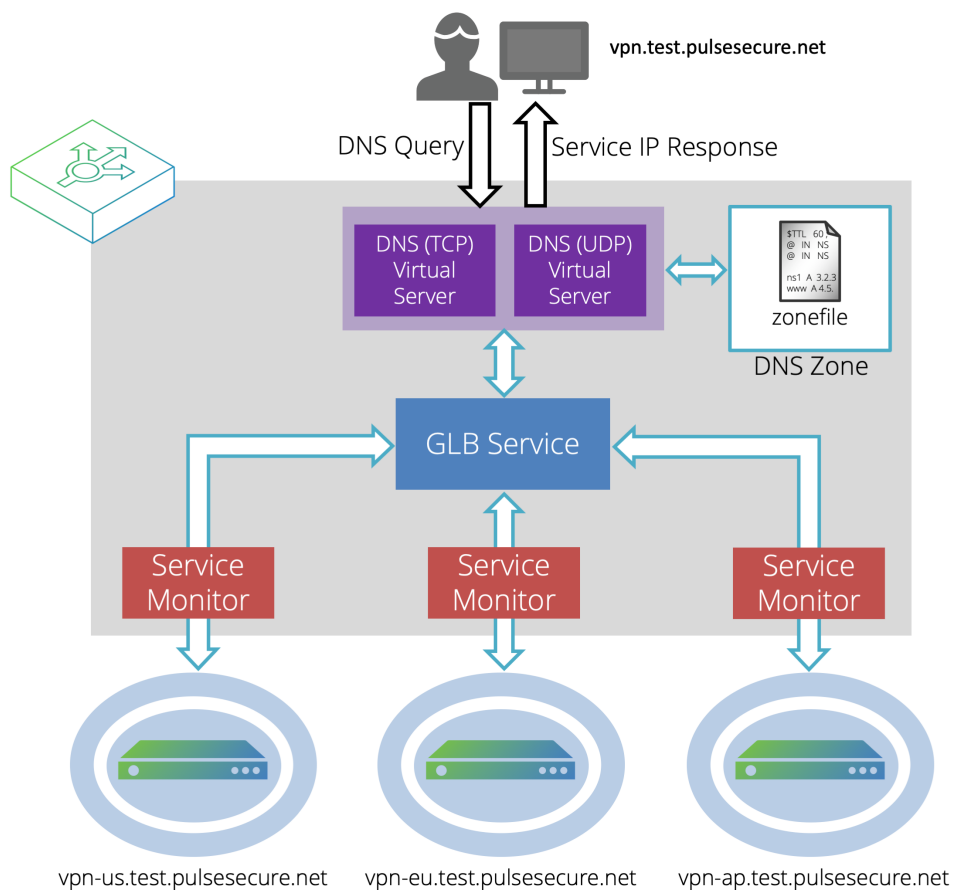

The Traffic Manager implements GSLB techniques as the Global Load Balancer (GLB) feature. The GLB feature uses a number of components, listed as follows:

- **DNS Virtual Servers:** Dual Virtual Servers listen for DNS requests over both TCP and UDP and return the IP address of the nearest available PCS service location.
- **DNS Zone:** Encapsulates a DNS Zone File and specifies the domain origin. The DNS Zone File contains the IP address and hostname mappings for your PCS services.
- **GLB Service:** Represents the global load balancing configuration that you want to use for a set of DNS domains. The GLB service links to the GLB locations and contains the load-balancing and monitoring logic used to determine the response to a DNS request for a given set of conditions.
- **Service Monitor:** Monitors the status of a GLB location and informs the load-balancing decision for each incoming request.

- **GLB Location:** The definition of a geographic location in the world. GLB locations are used by a GLB Service to determine where DNS responses should direct clients, based on proximity and availability. Each PCS service location is represented by a GLB Location.

To run the wizard, click the "Wizards" drop-down menu in the tool bar, then select "Optimal Gateway Selection".

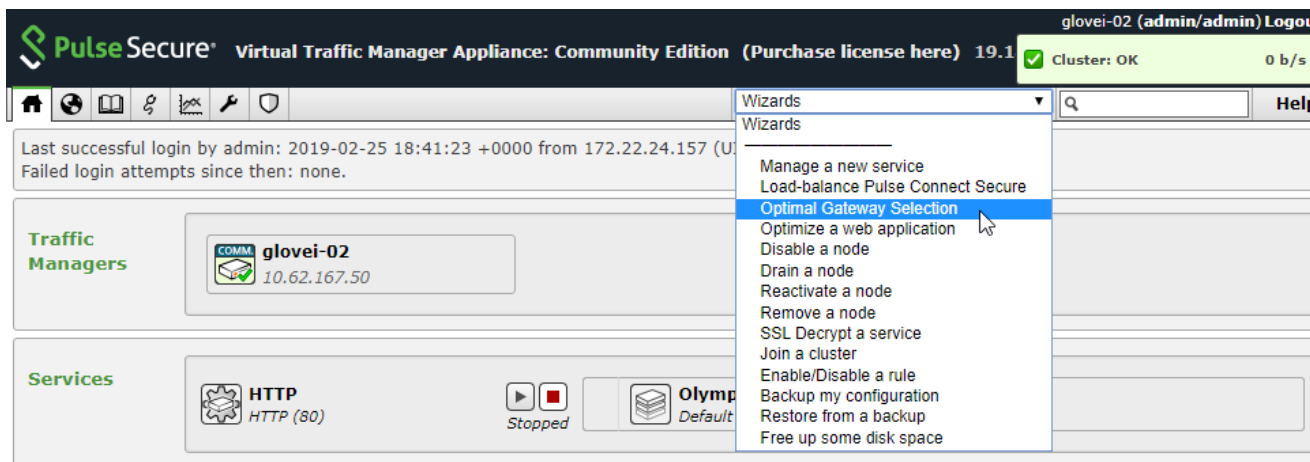

The Traffic Manager displays the first page of the wizard.

Optimal Gateway Selection, step 1 of 6

1. Overview

This wizard will guide you through the process of configuring the Virtual Traffic Manager for Optimal Gateway Selection of your globally-distributed Pulse Connect Secure gateway services.

This is achieved by configuring a single, unified, enterprise-wide endpoint URL. The Virtual Traffic Manager uses DNS-based Global Server Load Balancing (GSLB) to provide optimum gateway selection and dynamic failover based on a series of observed criteria:

- The geographic location of the user relative to the PCS gateways
- The current availability of the PCS gateways
- The measured load on the PCS gateways

The wizard requires you to input a domain, hostnames and service location IPv4 addresses for the service to be balanced.

If the service is to listen on a Traffic IP address, then an appropriate Traffic IP group should be created and enabled before commencing this wizard.

Cancel ◀ Back Next ▶

Click **Next** to continue.



On each wizard page, use **Cancel** to cancel the wizard without making any changes to the Traffic Manager. Use **Back** to return to the previous page and **Next** to continue on to the next page.

Optimal Gateway Selection, step 2 of 6

2. Service name

Enter a name to identify the service that is to be load-balanced.
All configuration created by this wizard will be prefixed with the name entered here.

Service Name:

The Traffic Manager uses the identifier you provide here as a prefix for all configuration objects it creates through this process.

Type an identifying name and click **Next** to continue.

Optimal Gateway Selection, step 3 of 6

3. Virtual Server configuration

Select which IP addresses or Traffic IP groups the service should listen on (port 53):

All IP addresses

Traffic IP Groups ...

| Traffic IP Group | Select |
|------------------|-------------------------------------|
| TIP | <input checked="" type="checkbox"/> |
| TIP2 | <input type="checkbox"/> |

Cancel ◀ Back Next ▶

Use this page to determine if the new DNS service listens on all IP addresses hosted by your Traffic Manager cluster, or just on the Traffic IP addresses in specific Traffic IP Groups. For further information on Traffic IP addresses and Groups, see [Traffic IP Groups and Fault Tolerance](#).

Click **Next** to continue.

Optimal Gateway Selection, step 4 of 6

4. Domain configuration

Enter a fully qualified domain name to be load-balanced.

Domain:

Enter the nameserver details below.

Primary nameserver domain:

Primary nameserver IP address:

Secondary nameserver domain:

Secondary nameserver IP address:

Cancel ◀ Back Next ▶

Enter the fully qualified domain name you want to use as your unified endpoint URL. Next, select the domain and IP address for your primary and secondary nameservers.

Click **Next** to continue.

Optimal Gateway Selection, step 5 of 6

5. Service locations

Add details of your PCS endpoint locations. For each endpoint, enter a name, IP address(es), and location information.

| | Hostname | IP address(es) | Country | Latitude | Longitude | Remove |
|----|-------------------------------------|--|---|---------------------------------------|--|---------------------------------------|
| 1. | <input type="text" value="eu-vpn"/> | <input type="text" value="192.0.2.0"/> | <input type="text" value="United Kingdom"/> | <input type="text" value="54.75844"/> | <input type="text" value="-2.69531"/> | <input type="button" value="Remove"/> |
| 2. | <input type="text" value="us-vpn"/> | <input type="text" value="192.0.2.1"/> | <input type="text" value="United States"/> | <input type="text" value="39.76"/> | <input type="text" value="-98.5"/> | <input type="button" value="Remove"/> |
| 3. | <input type="text" value="ap-vpn"/> | <input type="text" value="192.0.2.2"/> | <input type="text" value="Japan"/> | <input type="text" value="35.68536"/> | <input type="text" value="139.75309"/> | <input type="button" value="Remove"/> |

Enter a TCP port the backend service locations are listening on.

Service port:

Use this page to define your PCS service locations. For each location, enter a name, IP address(es), and physical location. The Traffic Manager uses this information to establish the GLB Locations used by your service. To add further locations, click **Add location**. To remove a location, click the adjacent **Remove** button.



For GLB Locations, the Traffic Manager supports IPv4 addresses only.

To specify the port number your locations listen on, use "Service port".

Click **Next** to continue.

Optimal Gateway Selection, step 6 of 6

6. Summary

The following configuration will be created:

| | | | | | | |
|---------------------------|-----------------|-------------|-----------------------|----------------|-----------------|------------------|
| Service: | PCS-OGS | | | | | |
| Domain: | vpn.example.com | | | | | |
| Service locations: | | Name | IP address(es) | Country | Latitude | Longitude |
| | 1. | eu-vpn | 192.0.2.0 | United Kingdom | 54.75844 | -2.69531 |
| | 2. | us-vpn | 192.0.2.1 | United States | 39.76 | -98.5 |
| | 3. | ap-vpn | 192.0.2.2 | Japan | 35.68536 | 139.75309 |
| Service port: | 443 | | | | | |
| Listening on: | TIP | | | | | |

To create this service, press 'Finish'. To change your settings, press 'Back'.

This page displays a summary of the proposed Traffic Manager settings. Click **Cancel** to quit the wizard without making any changes, click **Back** to return to the previous page, or click **Finish** to complete the wizard and configure the Traffic Manager.

After the wizard has completed all configuration, the Traffic Manager Home Page is updated to show all running services.

Troubleshooting

This chapter describes how to test that your Traffic Manager installation is working properly, and details the ways to deal with any problems you might encounter.

Tools and Techniques

If you are testing your Traffic Manager configuration, there are a range of tools and techniques you can make use of to understand your configuration, and the behavior of your network traffic:

- **Diagnosis:** The Cluster Diagnosis page runs a number of tests across your Traffic Manager system, checking network connectivity, health monitors, configuration errors and conflicting configuration.
- **Event Log:** The Event Log (displayed on the Home Page and the Event Log Page) records any significant events that have occurred.
- **Connections:** The Connections report gives an instant display of ongoing and recent connections: where they came from, how they were handled, how much data was transferred, etc.
- **Request Logging:** The Traffic Manager can write full logs so that you can record all the details about each request and response for later analysis.
- **Configuration Summary:** If you have a sophisticated configuration, the configuration summary describes what configuration objects are in use, and how they are related.
- **Audit Log:** The Audit Log records all configuration changes; when they were made, which user made them, and where the user came from.

This chapter describes each of these tools and techniques in detail.

Diagnosis and Event Logging

If you encounter any problems with your Traffic Manager system or configuration, the first step should be to check the **Cluster Diagnosis** page in the Traffic Manager Admin UI.

ATTENTION

If you cannot access the Admin UI on any of the Traffic Managers in your cluster, Ivanti recommends starting or restarting the Traffic Manager software. This process is described in the *Pulse Secure Virtual Traffic Manager: Installation and Getting Started Guide* applicable to your product variant. Take careful note of any error messages, particularly any messages appended to the error log file in `$ZEUSHOME/zxtm/log/errors`.

Click the **Diagnose** button on any page of the Admin UI to view the current system status. The **Diagnose** page is divided into sections that help you understand and resolve any issues you might have.

The **Cluster Diagnosis** section reports any problems the Traffic Manager finds with your setup, such as unavailable machines or bad configuration.

The **Event Log** shows the contents of the error logs on each Traffic Manager machine. You can view logs created in a recent period of your choice. The Event Log page dynamically updates as new event messages are added to the log.

The **Audit Log** shows recent configuration changes; when they were made, and which user made them.

The **Technical Support** section provides useful links to various resources, and an option to download technical support data for the Pulse Secure Technical Support team if necessary.



If you are using a Traffic Manager instance within a Pulse Secure Services Director deployment, use the “Support Entitlement” identifier displayed in this section when requesting assistance. Ivanti uses this information to uniquely identify your level of support entitlement.

If a problem is detected during normal usage, the **Status Applet** will indicate a warning or error condition. Visit the **Cluster Diagnosis** page for full details about the problem.

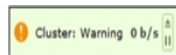
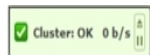

Monitoring Requests and Responses

If the **Cluster Diagnosis** page does not report any errors that are related to the problems you have observed, the next step is to verify that the Traffic Manager is correctly managing your traffic – reading requests on behalf of the back-end servers, and returning their responses back to the remote client.

You might find the suggestions in [Generating Test Requests](#) useful when attempting to reproduce any problems.

Connection Activity Report

To view connection activity on your Traffic Manager, click **Activity > Connections** in the Traffic Manager Admin UI. The **Connections** page gives a report of all ongoing and recently completed connections that the Traffic Manager has managed. Unfolding the **Key** section gives you details about the information shown.

You can see which Traffic Manager is currently handling the connection and the back-end node involved; the current state of the connection; and the virtual server, rule and pool currently involved with the connection. You can also see the retry count, idle times and byte counts for the connection.

To keep the data up to date, click the refresh button in your Internet browser. You can also download the data as a .tsv file.

Using the Connections Report



Verify that the Traffic Manager has managed the requests you are testing. If you do not see your test requests in this list, it is probable that the Traffic Manager never received the requests. Check your client configuration and DNS settings to verify that your test client is sending the requests to the Traffic Manager IP address, and that the request is then managed by one of your back-end servers.

One common error is that the back-end servers issue self-referential responses. For example, suppose that the Traffic Manager is managing traffic to "www.example.com", and the back-end servers are named "server1.example.com" and "server2.example.com". One of the servers issues a response containing a link or redirect to "server1.example.com". The client would subsequently try to contact the back-end server directly, bypassing the Traffic Manager and causing problems. Other protocols which embed DNS names or IP addresses in the response are also prone to this type of problem.

You can increase the size of the Connections report using the **System>Global Settings** page; look in the "Logging" section for the **recent_conns** key.

Request Logs

You can use the Request Logging facility of a virtual server to log many aspects of a transaction. This is very useful for long-term testing, if errors are intermittent or hard to replicate. Refer to [Request Logging](#) for configuration instructions.

if you have complicated TrafficScript logic, you can store debugging information for the connection, and log it in the request log. Use the `connection.data.set()` function to store the specific data for the connection in a TrafficScript rule, and then log that data in the request log with the `%{Key-name}d` macro.

Advanced Logging

You can use a TrafficScript rule to log information about the transactions managed by your virtual server.

TrafficScript functions can retrieve information about every part of a request. Functions such as `http.getHeader()` and `http.cookie()` give information about HTTP requests; functions such as `ssl.getSessionID()` provide details about SSL traffic. For other protocols, you can use the `connection.getData()` function to return a specified number of bytes of a request.

You can use the `log.info()` function to write details of the incoming requests to the Traffic Manager's event log file, to pinpoint any problems that are occurring with incoming traffic, or you can use the `event.emit()` function and configure an appropriate Event Handler to give you more control over where debugging messages are recorded.

See the "TrafficScript Reference" for details about available TrafficScript functions.

ATTENTION

Take care when logging such information: if you do this for every incoming request, the log file grows rapidly.

Monitoring Events

The TrafficScript function `counter.increment()` is used to count how many times a specific event occurred. For more information, please refer to [Activity > Current Activity](#).

Detailed Debugging of Connections

If a connection fails, the information logged in the connection activity report and request log will be incomplete because the connection did not complete normally. Connections may fail because of a variety of reasons, including protocol errors, timeouts or unexpected TCP closes.

To debug such unexpected problems, enable the **log!client_connection_failures** and **log!server_connection_failures** settings in the **Virtual Servers > Edit > Error Handling** configuration page for the affected service, as described in the [Handling Errors](#). These settings will configure your Traffic Manager to write detailed debug messages to the Event Log whenever a connection fails:

Event Log

The Event Log shows the contents of the error logs on each traffic manager machine.

Timescale: Last N events Event Filter: Show 'Configuration modified' messages: Yes No

Stop updating

| | | | | |
|---|----------------------------|------|---|--------|
| ✓ | 15/Jul/2009:11:56:46 +0100 | INFO | Virtual Server zws-8765: "Invalid HTTP response" S 10.100.1.186:38653 10.100.1.186:8765 "zws-18765" "yinkin:18765" "-" r 71 106 0 0 0 0 0 500 GET "http://yinkin:8765/nph-junk.cgi?foo=bar"e=%22&tab=%09" | yinkin |
| ✓ | 15/Jul/2009:11:56:45 +0100 | INFO | Virtual Server zws-8765: "Pool has no back-end nodes responding" 10.100.1.186:38651 10.100.1.186:8765 "testtcp" "-" "-" c 38 0 0 0 0 0 1 - GET "http://10.100.1.186:8765/" | yinkin |
| ✓ | 15/Jul/2009:11:56:45 +0100 | INFO | Virtual Server zws-8765: "Connect failure - Connection refused" S 10.100.1.186:38651 10.100.1.186:8765 "testtcp" "yinkin:13765" "-" c 38 0 0 0 0 0 0 - GET "http://10.100.1.186:8765/" | yinkin |

You can filter the event log to only display these messages using the "Connection Failures" Event Filter as illustrated above.

The log line contains a description of the error (for example, "Invalid HTTP Response") and details that describe the nature of the connection (node used, connection times, retries, etc). The Online Help for the **Services > Virtual Servers > Edit > Protocol Settings** configuration page describes the log format in detail.

Click the description to unfold a more readable representation of the connection error:

| | | | | | |
|--------------|---|------|---|---------------------|--------|
| ✓ | 15/Jul/2009:11:56:46 +0100 | INFO | Virtual Server zws-8765: "Invalid HTTP response" | | yinkin |
| | | | Peer | Server | |
| | | | Source Address | 10.100.1.186:38653 | |
| | | | Destination Address | 10.100.1.186:8765 | |
| | | | Pool | zws-18765 | |
| | | | Node | yinkin:18765 | |
| | | | Rule | - | |
| | | | Connection State | Reading from server | |
| | | | Bytes from client | 71 | |
| | | | Bytes to server | 106 | |
| | | | Bytes from server | 0 | |
| | | | Bytes to client | 0 | |
| | | | Connection Established | 0s | |
| | | | Client Idle Time | 0s | |
| | | | Server Idle Time | 0s | |
| | | | Connection Retries | 0 | |
| | | | Response Code | 500 | |
| Request Line | GET "http://yinkin:8765/nph-junk.cgi?foo=bar"e=%22&tab=%09" | | | | |

By default, connection errors are logged to the global Event Log. You can create an Event Handler that captures all Connection Failure events and writes them to a separate log file, and bypasses the global Event Log. For more details, see [Event Handling and Alerts](#).

Testing Individual Nodes

To check that each back-end node in a pool can receive requests from the Traffic Manager, switch the load-balancing algorithm for the pool to "Round Robin" (see [Load Balancing](#)). The Round Robin load-balancing algorithm routes requests to each node in turn; you can use the logs on your back-end servers to check that this is working for every node.

You can also configure nodes to drain connections (see [Draining, Disabling, or Removing a Node](#)). If you have several nodes in a pool, you can temporarily stop the Traffic Manager sending traffic to some by setting them to drain. To test each node in turn, you can drain all the nodes apart from the one you wish to test.

Enable server logging on each node and verify that the logs the nodes write are consistent with the activity on the system.

Understanding Your Configuration

The configuration summary provides an overview of how requests are processed with the Traffic Manager. Requests are received by the Traffic Manager, processed by a virtual server and a pool, forwarded to a node, and then the response is processed by the pool and virtual server on the return path.

The processing path can be quite complex when a number of TrafficScript rules and the Traffic Manager capabilities are in effect.

The Configuration Summary is described in [Services > Configuration Summary](#).

If you can trace the problem under investigation to a particular time, use the **Diagnose > Audit Log** page and, if required, the **System > Backups** page to identify configuration changes that might have provoked the problem.

The Audit Log records all configuration changes performed by each user of the Traffic Manager Admin UI, REST API, and SOAP API. You might wish to give each authorized administrator an individual login so that you can manage their privileges and monitor their activities. User and Group configuration is described in [User Management](#).

Backup Management allows you to manually take snapshots of your configuration. You can compare the current configuration with a known good snapshot, and restore backups in the event of a serious configuration problem. Backup Management is described in [System > Backups](#).

Troubleshooting Tips

The process of diagnosing faults in a complex traffic-managed cluster is an involved one, and a systematic approach to troubleshooting is required. In the event of any problems, check through the following areas in turn to locate and diagnose the cause of the fault.

Generating Test Requests

You can test your system using the normal client software that users will employ, such as a Web browser or email client. Tools like the "Live HTTP Headers" extension for Mozilla browsers are very useful when inspecting the request and response flow between the client and the Traffic Manager.

You can also use a network snooping tool such as Wireshark (<http://www.wireshark.org/>) to record network traffic and assemble request and response sessions.

httpclient

The “httpclient” program, included with the Traffic Manager distribution, can be used to issue HTTP requests to particular machines. You can find it at `$ZEUSHOME/admin/bin/httpclient`.

Use the following syntax:

```
httpclient --hostheader=<website_name> http://<trafficIP>/
```

You can also perform initial tests using a telnet client to perform a basic test on the service:

```
$ telnet www.mysite.com 80
Trying 62.254.209.66...
Connected to 62.254.209.66.
GET / HTTP/1.1<RETURN>
Host: www.mysite.com<RETURN>
<RETURN>
```

The openssl toolkit (<http://www.openssl.org/>) includes a Telnet-like client that uses the SSL protocol, for testing SSL-related problems.

zeusbench

The “zeusbench” program is a useful benchmarking tool that can be used to send large numbers of HTTP requests for load and performance testing purposes. You can find it at `$ZEUSHOME/admin/bin/zeusbench`.

There are many command line options. You can run a simple load test using the following command:

```
zeusbench -t 30 -c 100 -k http://host/url
```

Run `zeusbench -h` for a full list of command line options.

Checking Automatic Back-End Failover

To check the Traffic Manager’s automatic failover of back ends you will need at least two back-end servers configured, or there will be no machines for the Traffic Manager to fall back on. You can test failover by pulling out the network cable on one of the back-end machines; or you can manually stop the service running on the back end. Verify that nothing is then listening on that port on the back end.

If you only have one back-end server you could run two instances of the required service on different ports on the same server machine, and then manually stop one instance of the service.

Try to use your selected service through the Traffic Manager. For SMTP send an email through the server farm, or for HTTP make a Web page request. If at least one back-end server is available to fulfill your request it should succeed.

Check the **Diagnose > Event Log** page for notification that a back-end machine has failed.

Checking Automatic Front-End Failover

If you have two or more Traffic Managers, you can check that automatic front-end failover is working properly. Set up a traffic IP group spanning your Traffic Managers, and a service using this traffic IP group, such as a virtual server managing Web content on port 80. Check that you can request Web pages from this service successfully on each of the traffic IP addresses in the group. You can do this by entering the IP address rather than the DNS name in your browser.

Click **Services > Traffic IP Groups** and then click **Unfold All** to view details about your traffic IP groups. This shows you which machine has raised which IP address; note that if you have more machines than traffic IP addresses in the group, some machines will be on standby and not actively handling traffic.

Now pick a machine that has raised one of the traffic IP addresses, and pull out all the network cables on that machine. The IP address will be raised by another machine in the group; try browsing to the traffic IP address again and check that you can still receive content. You may need to refresh the page in your browser to ensure that it is not using cached content.

[Configuring Fault-Tolerance](#) describes how the Traffic Manager's fault tolerance works, the tests that it conducts, and the decisions that it makes.

Common Problems

Did Not Become Root

The Traffic Manager needs to bind to privileged ports to balance network services like mail and HTTP (privileged ports are ports below number 1024). To do this you need to install, run the configure script and start the Traffic Manager as root.

In front-end fault tolerance mode, the Traffic Manager needs to raise and lower network interfaces. If you did not configure and start the software as root, the failover architecture does not function.

Note that the Traffic Manager runs as a non-privileged user, but it has to be configured as, and started as the root user.

For evaluation purposes, it is possible to configure and start the Traffic Manager without becoming root. However, in this case you will not be able to bind to privileged ports (see above), nor use fault tolerance.

Connection Refused

The most common configuration error for front ends is a bad DNS setup mapping the external name to the external IP addresses for your front-end machines. If you receive a “Connection Refused” message when connecting to your server through the front-end DNS name, it is likely that your DNS is not configured correctly.

To check your DNS configuration, you can use the `host` or `nslookup` commands:

```
$ host www.w3.org
www.w3.org has address 18.29.1.35
www.w3.org has address 18.7.14.127
www.w3.org has address 18.29.1.34
```

Verify that your Traffic Manager machines are listening on these IP addresses.

You can configure a virtual server to listen for traffic on these IP addresses explicitly. Then the Diagnose page will report an error if these IP addresses are not available to the Traffic Manager cluster.

Inappropriate Traffic IP Addresses Configured

If you configure a traffic IP group for front-end fault tolerance, the Traffic Manager will make a number of checks to ensure that the traffic IP addresses you select are sensible. However, you should also double-check that they are appropriate for your current network configuration. Common errors include selecting traffic IP addresses that are used elsewhere (including as permanent IP addresses on the Traffic Manager machines), IP addresses that do not lie in the subnets used by the Traffic Managers, or IP addresses that are not routable from elsewhere.

The Traffic Manager Drops Connection Before Protocol Begins

For server first protocols, when the Traffic Manager cannot contact any back ends for work for a particular port for server first protocols, it will have no choice other than to drop the connection with the client. If you connect to the correct port on the Traffic Manager machine (using telnet for instance), and get a successful connection (i.e. no “Connection Refused” message), but the connection drops almost immediately, the Traffic Manager is trying to talk to a back end but cannot find any.

Check the **Diagnose > Event Log** page for messages about the status of the back-end servers.

Web Server Returns Error 400

If on testing your traffic-managed Web site you only get errors of type Error 400 Bad Request, this may be because the Web site you are trying to access has not been configured to accept any other host headers (or aliases). In order to resolve this problem you can add a rule to set the right host header:

```
http.setHeader( "Host", "www.mysite.com" );
```

Wrong Port Number Configured

Another common problem is the wrong port number being balanced. If, for instance, your Web site is running on a port other than 80, you will need to balance that port number with the HTTP protocol rather than the default. If you are running an SSL-encrypted site, you should select the HTTPS protocol rather than HTTP, or SSL-decrypt your traffic. The default port for HTTPS is 443.

Note that it is possible to balance many distinct ports with one Traffic Manager installation, provided an appropriate protocol is selected in each case.

Running Out of File Descriptors

Your Traffic Manager uses operating system resources called "file descriptors" to manage each network connection to a client or server. There is a hard limit on the number of file descriptors the Traffic Manager can allocate (the limit applies per process, in other words, per CPU core), set in the operating system.

Under times of very high load, such as during a benchmark, you might see an error message indicating that you are "Running out of file descriptors". In this case, you can increase the number of file descriptors that your Traffic Manager uses.

To increase the maximum number of file descriptors, log into the Admin UI and click **System > Global Settings**. In the "System Settings" section, increase the value of **maxfds** to a larger value. If you are already at the maximum that your operating system allows, refer to the following Pulse Secure Knowledge Center article to ascertain whether this hard limit can be increased:

https://kb.pulsesecure.net/articles/Pulse_Secure_Article/KB43935

Running Out of Disk Space

 This section is applicable to appliance and cloud variants only.

Over time, your appliance can run low on disk space. For example, your system logs can become large if you have configured your Traffic Manager to produce detailed request log information. Additionally, archived software revisions (used by the Traffic Manager for roll back) might no longer be required.

The Traffic Manager warns you if disk space is running low through the **Diagnose > Event Log** and **Diagnose > Cluster Diagnosis** page. You can also view disk space usage at any time through the **System > Traffic Managers** page.

To free up disk space, click on "Free up some disk space" from the **Wizards:** drop-down menu in the top navigation bar. You can also run the wizard from the "Free Disk Space" link on the **System > Traffic Managers** page at any time, and from the **Diagnose > Cluster Diagnosis** page when a low disk space warning appears.

ATTENTION

This operation is irreversible. You should ensure you have created a backup of any files you need to keep before running the wizard. Note also that any "Technical Support Reports" you create afterwards contain only those logs generated since the wizard was run.

Getting Help

If you need to contact a technical support engineer, please include the Technical Support Report (TSR) download as an attachment to your problem report. The report download contains your recent log files, configuration, system activity and a variety of internal information.

To create, download, and manage your TSRs, click **Manage Technical Support Reports** on the **Diagnose > Technical Support** page of the Admin UI.

Use this page to choose what options are included in your generated TSR, and to access previously generated reports. The Traffic Manager stores the last 10 TSRs generated, with the option to download or delete each one. You can free disk space by downloading TSRs to an external location and then deleting them from the Traffic Manager using the check boxes provided.

You can also generate a TSR using the command line or through the SOAP API. Use these options when access to the Admin UI is interrupted.

To generate a TSR from the command line, run the following script:

```
$ZEUSHOME/zxtm/bin/support-report [--all-logs] <outfile>
```

Use the optional `--all-logs` argument to bypass the default log file size download limit of 10 MB. This means that the entire log set is included in the support report, regardless of size.

Glossary

Below is an explanation of terms used in this document. Some of these terms are used with varying meanings in computing literature; this glossary is intended only to define them within the scope of this document.

| Term | Meaning |
|-----------------------------------|--|
| Action | An action is invoked when an event handler is triggered as the result of a particular event occurring. Possible actions include writing to log files, sending an email message, sending a SYSLOG message or SNMP trap, or running a custom action program. |
| Admin Server | The process that serves the Web-based Admin UI, and handles configuration and status communications between the core Traffic Manager software, the Admin UI, and all product APIs. |
| Audit log | The Traffic Manager's audit log of users' activities for the Traffic Manager. These can be viewed within the Diagnose pages. |
| Back-end IP address | The IP address which a Traffic Manager machine uses to communicate with a back-end server, or the IP address of a back-end server. |
| Back-end server | A machine which runs a service, such as a Web or mail server. A back-end server is typically within your local network, and requests handled by the Traffic Manager are passed on to it. A back-end server together with a specified port forms a node in the Traffic Manager. |
| Bandwidth management | The ability to monitor and control the amount of network bandwidth available to a particular service or type of request. |
| Catalog | A central repository for objects which you can apply to your services. There are catalogs for rules, monitors, service protection classes and various SSL items. |
| Certificate authority | A recognized authority which independently signs SSL certificates. |
| Certificate revocation list (CRL) | A list of client SSL certificates which should be considered invalid; issued by a certificate authority. |

| Term | Meaning |
|--------------------------------------|--|
| Certificate signing request (CSR) | A request created from a self-signed certificate. You can submit the CSR to a certificate authority for them to sign. |
| CIDR IP subnet | A Classless Inter-Domain Routing (CIDR) IP subnet includes a standard 32-bit IP address and additional information on how many bits are used for the network prefix. For example, in the CIDR IP subnet "10.13.1.48/22", the "/22" indicates that the first 22 bits are used to identify the unique network prefix and the remaining 10 bits identify the specific host. Alternatively, the Traffic Manager allows to specify a CIDR IP subnet using a subnet mask "10.13.1.48/255.255.255.0" or explicitly "10.13.1." |
| Client certificate | An SSL certificate held by a client, granting the client access to a restricted site. |
| Cluster | A group of Traffic Managers which share the same configuration. |
| configure script | The script which must be run after installing and before starting the Traffic Manager. It deals with fundamental settings such as passwords and specifying whether the Traffic Manager should stand alone or join an existing cluster. |
| Cookie | A small item of data given to a client by a server that is stored either on the client's file system or in the browser client session. The client stores the data and provides it to the server on subsequent requests. Cookies are used to track client data such as session persistence maps. |
| Denial of Service attack | A malicious attempt to prevent legitimate use of a service, often by flooding a network or disrupting connectivity between machines. |
| Diagnose pages | The section of the Admin UI that helps you diagnose and fix any faults with your Traffic Manager setup. |
| Disabled node | A node in a pool that is not used; it is not monitored, and no traffic is sent to it. Disabling a node is an alternative to removing the node from the pool, but disabling it allows it to be reinstated more easily. |
| Distributed Denial of Service attack | A Denial of Service attack which comes from a group of machines; these machines have often been compromised by worms or viruses. |

| Term | Meaning |
|----------------------|---|
| DMZ | The demilitarized zone for a firewall. This zone sits between the internal network and the Internet, and often holds your externally available servers. |
| Draining node | A node in a pool which is being sent no new connections. When all existing connections and sessions to this node have expired, it can be removed from the pool safely. |
| Error file | A file sent to the client when no nodes are available to respond to its request. Error files are set up on a per-pool basis. |
| Event | An event is raised when a particular change or occurrence takes place, such as an IP Address transfer or a node failure or recovery. All events are logged to the global Event Log. |
| Event Handler | An event handler configures the actions that the Traffic Manager should take when an event in the associated Event Type occurs. |
| Event Log | The Traffic Manager's log of events within the Traffic Manager. These are graded as INFO, WARN, SERIOUS, FATAL etc, and can be viewed within the Diagnose pages. |
| Event Type | A set of events, grouped for administrative convenience. When any event in a particular event type occurs, the Traffic Manager can run the actions associated with that event type. |
| Failover | The act of taking on a failed machine's load by other machines in the cluster. |
| Failure pool | If all the nodes in a pool should fail, requests will be sent to its failure pool, if one is configured. |
| Fault tolerance | The ability of a cluster or pool to cope with failure of one or more of its servers, without interruption to service. |
| Front-end IP address | The permanent, externally available IP address of a Traffic Manager. |
| Front-end server | A server which is contactable from the Internet, such as a Traffic Manager. |

| Term | Meaning |
|-------------------|--|
| Health monitoring | The process by which the Traffic Manager tracks the health of Traffic Managers and back ends, so that requests will not be sent to a failed machine. |
| IPv6 | A network layer protocol that is expected to supersede the current protocol, IPv4. Its features include a bigger range of addresses, higher security and further advantages. |
| Java extension | Java Extensions can increase (“extend”) the capabilities of TrafficScript. A TrafficScript rule (or RuleBuilder rule) can invoke a Java Extension to process a request or response, and the Java run-time environment provides a much more powerful set of programming language tools and libraries than TrafficScript does alone. |
| Load balancing | The distribution of requests among a number of back-end servers, so that every request is dealt with as quickly as possible. |
| MD5 | In cryptography, MD5 (Message-Digest algorithm 5) is a widely used cryptographic hash function with a 128-bit hash value. As an Internet standard (RFC 1321), MD5 has been employed in a wide variety of security applications, and is also commonly used to check the integrity of files. |
| MIME type | Multipart Internet Mail Extension, a name which identifies the type of data being transferred. For example, “application/pdf” for PDF files. This standard was first used in email applications, and has been widely adopted by other Internet technologies such as Web servers. |
| Monitor | A regular test which the Traffic Manager uses to track the health of a pool. |
| Name server | A server that implements a name service protocol. For example, a Domain Name System (DNS) server might translate the domain name www.example.com to the IP address 208.70.196.59. |

| Term | Meaning |
|-------------------------------------|--|
| NAT | Network address translation (NAT, also known as network masquerading) involves rewriting the source or destination addresses of IP packets as they pass through a router or firewall. Most systems using NAT do so in order to enable multiple hosts on a private network to access the Internet using a single public IP address. |
| Node | A back-end server with an associated port, which receives requests sent to it by the Traffic Manager and responds with the requested content. |
| PEM | Private Enhanced Mail. The .pem file extension is used for Base 64-encoded X.509 keys and certificates. These are printable text, and start with a line of the form: ----- BEGIN CERTIFICATE ----- |
| PKCS#11 | The standard used to communicate with secure hardware. |
| Pool | A logical group of nodes. When a virtual server assigns requests to a pool, it load-balances them across the nodes. |
| Protocol Settings | Settings for managing the connection between a remote client and a virtual server, or between a pool and its nodes. |
| Real Time Streaming Protocol (RTSP) | An application-level protocol that enables on-demand delivery of real-time data, such as audio and video formats, using the TCP and UDP protocols. |
| Real-time Transport Protocol (RTP) | A UDP packet format for delivering audio and video files, which is commonly used alongside RTSP to provide the delivery of the streaming data. |
| Request Rule | A TrafficScript or RuleBuilder rule that controls how the Traffic Manager should handle a request. Rules are invoked by a virtual server, and can inspect, manipulate, rewrite and route requests; they can also control how other capabilities in the Traffic Manager are used to manage the request. |
| Response Rule | the counterpart of request rules, response rules control how the Traffic Manager should handle a response. |

| Term | Meaning |
|-----------------------------------|---|
| RuleBuilder | A visual editor for creating rules, which allows you to select conditions on the request to be examined, and actions that follow if any or all of these conditions are met. |
| Self-signed SSL certificate | An SSL certificate signed by its owner, rather than a certificate authority. These are useful for security testing but should not be used for live sites. You can issue a certificate signing request to convert your certificate to one signed by a certificate authority. |
| Server certificate | An SSL certificate used to identify an SSL service (such as a Web site), and containing the public key necessary to set up the encrypted transaction. |
| Service | Common Internet services include Web, mail, DNS and applications such as .NET and SOAP. They are provided, publicly or locally, through an IP or DNS address and port combination. |
| Service level monitoring | The ability to monitor back-end server response times, compare them to a conformance value and react to changes, including dynamically adjusting the resources available. |
| Service protection | The protection of your Internet services from attacks such as denial of service (DoS) and distributed denial of service (DDoS). |
| Service protection class | A group of service protection settings you define. The class is held in the Service Protection Catalog and can be applied to any virtual server. |
| Session Initiation Protocol (SIP) | A protocol used in Internet for conferencing, telephony, presence, events and instant messaging. |
| Session persistence | A process by which requests belonging to the same user session are always sent to the same node. Sessions can be identified by several methods including IP addresses, cookies or SSL session IDs. |
| SNMP | Simple Network Management Protocol, an open standard for network monitoring and management. It allows you to monitor devices on a network and gather performance data. |

| Term | Meaning |
|--------------------|---|
| SOAP | Simple Object Access Protocol, an XML-based standard for Web services messages. |
| SSL | Secure Sockets Layer, a protocol which provides encrypted communications over a network. Requests can be decrypted and re-encrypted within the Traffic Manager. |
| Tarball | A file in the tar file format, a standard type of archive file format. It is used widely to archive and unarchive files while preserving file system information such as user and group permissions, dates, and directory structures. |
| Traffic IP address | An IP address you use to publish an Internet service, usually linked to your public DNS entry. |
| Traffic IP group | A logical group containing several traffic IP addresses, and spanning some or all of your Traffic Managers. These Traffic Managers negotiate to ensure that the IP addresses in the group are always available. |
| Traffic Manager | A front-end server running the Traffic Manager and managing your services. |
| Traffic cluster | The ability to deploy unlimited numbers of active and passive Traffic Managers, providing resilience to multiple failures and the ability to scale the Traffic Manager cluster as the need arises. Also known as N+M Redundancy. |
| TrafficScript | The scripting language used to write rules for the Traffic Manager range of solutions. |
| Vector | The means or vehicle by which a Denial of Service or Distributed Denial of Service attack is made. |
| Virtual server | An interface between the Traffic Manager and the Internet. A virtual server manages one of your services. It receives a request from the Internet and, possibly after SSL-decrypting it and applying rules, assigns it to a pool. |

| Term | Meaning |
|------------|--|
| XML | Extensible Markup Language, used for storing and exchanging structured data. |
| XPath | A language for addressing parts of an XML document. It can be used in conjunction with TrafficScript rules to make decisions based on the document's content. |
| \$ZEUSHOME | The location in which you install the Traffic Manager. The default is /usr/local/zeus for Traffic Manager software variants, and /opt/zeus for appliances and cloud instances. |

Software License Acknowledgments

This chapter lists license acknowledgments for third party software used in the core Traffic Manager software.

For third party software license acknowledgements related to the Operating System layer used in the Traffic Manager appliance and cloud variants, see instead the Pulse Secure Virtual Traffic Manager: Appliance License Acknowledgements, available from the Ivanti Web site (www.ivanti.com).

License for the Berkeley DB Code (Version 1.85)

The following license refers to the libdb code that the Traffic Manager is linked against. The source for this code can be found at: <http://www.sleepycat.com/update/snapshot/db.1.85.tar.gz>

Copyright (c) 1991, 1993 The Regents of the University of California. All rights reserved.

Redistribution and use in source and binary forms, with or without modification, are permitted provided that the following conditions are met:

Redistributions of source code must retain the above copyright notice, this list of conditions and the following disclaimer.

Redistributions in binary form must reproduce the above copyright notice, this list of conditions and the following disclaimer in the documentation and/or other materials provided with the distribution.

All advertising materials mentioning features or use of this software must display the following acknowledgement:

This product includes software developed by the University of California, Berkeley and its contributors.

Neither the name of the University nor the names of its contributors may be used to endorse or promote products derived from this software without specific prior written permission.

THIS SOFTWARE IS PROVIDED BY THE REGENTS AND CONTRIBUTORS "AS IS" AND ANY EXPRESS OR IMPLIED WARRANTIES, INCLUDING, BUT NOT LIMITED TO, THE IMPLIED WARRANTIES OF MERCHANTABILITY AND FITNESS FOR A PARTICULAR PURPOSE ARE DISCLAIMED. IN NO EVENT SHALL THE REGENTS OR CONTRIBUTORS BE LIABLE FOR ANY DIRECT, INDIRECT, INCIDENTAL, SPECIAL, EXEMPLARY, OR CONSEQUENTIAL DAMAGES (INCLUDING, BUT NOT LIMITED TO, PROCUREMENT OF SUBSTITUTE GOODS OR SERVICES; LOSS OF USE, DATA, OR PROFITS; OR BUSINESS INTERRUPTION) HOWEVER CAUSED AND ON ANY THEORY OF LIABILITY, WHETHER IN CONTRACT, STRICT LIABILITY, OR TORT (INCLUDING NEGLIGENCE OR OTHERWISE) ARISING IN ANY WAY OUT OF THE USE OF THIS SOFTWARE, EVEN IF ADVISED OF THE POSSIBILITY OF SUCH DAMAGE.

RSA PKCS11

License to copy and use this software is granted provided that it is identified as "RSA Security Inc. PKCS #11 Cryptographic Token Interface (Cryptoki)" in all material mentioning or referencing this software or this function.

License is also granted to make and use derivative works provided that such works are identified as "derived from the RSA Security Inc. PKCS #11 Cryptographic Token Interface (Cryptoki)" in all material mentioning or referencing the derived work.

License for OpenLDAP

The following license refers to the libldap code that the Traffic Manager is linked against. The source for this code can be found at: <ftp://ftp.openldap.org/pub/OpenLDAP/openldap-release/openldap-2.4.47.tgz>

Version: 2.4.47

License summary: OpenLDAP Public License

Copyright:

The OpenLDAP Public License

Version 2.8, 17 August 2003

Redistribution and use of this software and associated documentation ("Software"), with or without modification, are permitted provided that the following conditions are met:

1. Redistributions in source form must retain copyright statements and notices,

2. Redistributions in binary form must reproduce applicable copyright statements and notices, this list of conditions, and the following disclaimer in the documentation and/or other materials provided with the distribution, and

3. Redistributions must contain a verbatim copy of this document.

The OpenLDAP Foundation may revise this license from time to time. Each revision is distinguished by a version number. You may use this Software under terms of this license revision or under the terms of any subsequent revision of the license.

THIS SOFTWARE IS PROVIDED BY THE OPENLDAP FOUNDATION AND ITS CONTRIBUTORS "AS IS" AND ANY EXPRESSED OR IMPLIED WARRANTIES, INCLUDING, BUT NOT LIMITED TO, THE IMPLIED WARRANTIES OF MERCHANTABILITY AND FITNESS FOR A PARTICULAR PURPOSE ARE DISCLAIMED. IN NO EVENT SHALL THE OPENLDAP FOUNDATION, ITS CONTRIBUTORS, OR THE AUTHOR(S) OR OWNER(S) OF THE SOFTWARE BE LIABLE FOR ANY DIRECT, INDIRECT, INCIDENTAL, SPECIAL, EXEMPLARY, OR CONSEQUENTIAL DAMAGES (INCLUDING, BUT NOT LIMITED TO, PROCUREMENT OF SUBSTITUTE GOODS OR SERVICES; LOSS OF USE, DATA, OR PROFITS; OR BUSINESS INTERRUPTION) HOWEVER CAUSED AND ON ANY THEORY OF LIABILITY, WHETHER IN CONTRACT, STRICT LIABILITY, OR TORT (INCLUDING NEGLIGENCE OR OTHERWISE) ARISING IN ANY WAY OUT OF THE USE OF THIS SOFTWARE, EVEN IF ADVISED OF THE POSSIBILITY OF SUCH DAMAGE.

The names of the authors and copyright holders must not be used in advertising or otherwise to promote the sale, use or other dealing in this Software without specific, written prior permission. Title to copyright in this Software shall at all times remain with copyright holders.

OpenLDAP is a registered trademark of the OpenLDAP Foundation.

Copyright 1999-2003 The OpenLDAP Foundation, Redwood City, California, USA. All Rights Reserved. Permission to copy and distribute verbatim copies of this document is granted.

PCRE2 License

The following license refers to the pcre2 code that the Traffic Manager is linked against.

Version: 10.35

License summary: BSD + exemption

Copyright:

PCRE2 is a library of functions to support regular expressions whose syntax and semantics are as close as possible to those of the Perl 5 language.

Releases 10.00 and above of PCRE2 are distributed under the terms of the "BSD" licence, as specified below, with one exemption for certain binary redistributions. The documentation for PCRE2, supplied in the "doc" directory, is distributed under the same terms as the software itself. The data in the testdata directory is not copyrighted and is in the public domain.

The basic library functions are written in C and are freestanding. Also included in the distribution is a just-in-time compiler that can be used to optimize pattern matching. This is an optional feature that can be omitted when the library is built.

THE BASIC LIBRARY FUNCTIONS

Written by: Philip Hazel
Email local part: ph10
Email domain: cam.ac.uk

University of Cambridge Computing Service,
Cambridge, England.

Copyright (c) 1997-2020 University of Cambridge
All rights reserved.

PCRE2 JUST-IN-TIME COMPILATION SUPPORT

Written by: Zoltan Herczeg
Email local part: hzmester
Email domain: freemail.hu

Copyright(c) 2010-2020 Zoltan Herczeg
All rights reserved.

STACK-LESS JUST-IN-TIME COMPILER

Written by: Zoltan Herczeg
Email local part: hzmester
Email domain: freemail.hu

Copyright(c) 2009-2020 Zoltan Herczeg
All rights reserved.

THE "BSD" LICENCE

Redistribution and use in source and binary forms, with or without modification, are permitted provided that the following conditions are met:

- Redistributions of source code must retain the above copyright notice, this list of conditions and the following disclaimer.
- Redistributions in binary form must reproduce the above copyright notice, this list of conditions and the following disclaimer in the documentation and/or other materials provided with the distribution.
- Neither the name of the University of Cambridge nor the names of any contributors may be used to endorse or promote products derived from this software without specific prior written permission.

THIS SOFTWARE IS PROVIDED BY THE COPYRIGHT HOLDERS AND CONTRIBUTORS "AS IS" AND ANY EXPRESS OR IMPLIED WARRANTIES, INCLUDING, BUT NOT LIMITED TO, THE IMPLIED WARRANTIES OF MERCHANTABILITY AND FITNESS FOR A PARTICULAR PURPOSE ARE DISCLAIMED. IN NO EVENT SHALL THE COPYRIGHT OWNER OR CONTRIBUTORS BE LIABLE FOR ANY DIRECT, INDIRECT, INCIDENTAL, SPECIAL, EXEMPLARY, OR CONSEQUENTIAL DAMAGES (INCLUDING, BUT NOT LIMITED TO, PROCUREMENT OF SUBSTITUTE GOODS OR SERVICES; LOSS OF USE, DATA, OR PROFITS; OR BUSINESS INTERRUPTION) HOWEVER CAUSED AND ON ANY THEORY OF LIABILITY, WHETHER IN CONTRACT, STRICT LIABILITY, OR TORT (INCLUDING NEGLIGENCE OR OTHERWISE) ARISING IN ANY WAY OUT OF THE USE OF THIS SOFTWARE, EVEN IF ADVISED OF THE POSSIBILITY OF SUCH DAMAGE.

EXEMPTION FOR BINARY LIBRARY-LIKE PACKAGES

The second condition in the BSD licence (covering binary redistributions) does not apply all the way down a chain of software. If binary package A includes PCRE2, it must respect the condition, but if package B is software that includes package A, the condition is not imposed on package B unless it uses PCRE2 independently.

License for Yahoo! UI Library

Copyright (c) 2009, Yahoo! Inc. All rights reserved.

Redistribution and use of this software in source and binary forms, with or without modification, are permitted provided that the following conditions are met:

Redistributions of source code must retain the above copyright notice, this list of conditions and the following disclaimer.

Redistributions in binary form must reproduce the above copyright notice, this list of conditions and the following disclaimer in the documentation and/or other materials provided with the distribution.

Neither the name of Yahoo! Inc. nor the names of its contributors may be used to endorse or promote products derived from this software without specific prior written permission of Yahoo! Inc.

THIS SOFTWARE IS PROVIDED BY THE COPYRIGHT HOLDERS AND CONTRIBUTORS "AS IS" AND ANY EXPRESS OR IMPLIED WARRANTIES, INCLUDING, BUT NOT LIMITED TO, THE IMPLIED WARRANTIES OF MERCHANTABILITY AND FITNESS FOR A PARTICULAR PURPOSE ARE DISCLAIMED. IN NO EVENT SHALL THE COPYRIGHT OWNER OR CONTRIBUTORS BE LIABLE FOR ANY DIRECT, INDIRECT, INCIDENTAL, SPECIAL, EXEMPLARY, OR CONSEQUENTIAL DAMAGES (INCLUDING, BUT NOT LIMITED TO, PROCUREMENT OF SUBSTITUTE GOODS OR SERVICES; LOSS OF USE, DATA, OR PROFITS; OR BUSINESS INTERRUPTION) HOWEVER CAUSED AND ON ANY THEORY OF LIABILITY, WHETHER IN CONTRACT, STRICT LIABILITY, OR TORT (INCLUDING NEGLIGENCE OR OTHERWISE) ARISING IN ANY WAY OUT OF THE USE OF THIS SOFTWARE, EVEN IF ADVISED OF THE POSSIBILITY OF SUCH DAMAGE.

License for ssleay Cryptographic Library

The following license refers to an implementation of the SHA-1 and MD5 algorithms used in Pulse Secure Virtual Traffic Manager:

Copyright (C) 1997 Eric Young (eay@cryptsoft.com). All rights reserved.

Redistribution and use in source and binary forms, with or without modification, are permitted provided that the following conditions are met:

1. Redistributions of source code must retain the copyright notice, this list of conditions and the following disclaimer.
2. Redistributions in binary form must reproduce the above copyright notice, this list of conditions and the following disclaimer in the documentation and/or other materials provided with the distribution.

3. All advertising materials mentioning features or use of this software must display the following acknowledgement: "This product includes cryptographic software written by Eric Young (eay@cryptsoft.com)". The word 'cryptographic' can be left out if the routines from the library being used are not cryptographic related :-).
4. If you include any Windows specific code (or a derivative thereof) from the apps directory (application code) you must include an acknowledgement: "This product includes software written by Tim Hudson (tjh@cryptsoft.com)"

THIS SOFTWARE IS PROVIDED BY ERIC YOUNG "AS IS" AND ANY EXPRESS OR IMPLIED WARRANTIES, INCLUDING, BUT NOT LIMITED TO, THE IMPLIED WARRANTIES OF MERCHANTABILITY AND FITNESS FOR A PARTICULAR PURPOSE ARE DISCLAIMED. IN NO EVENT SHALL THE AUTHOR OR CONTRIBUTORS BE LIABLE FOR ANY DIRECT, INDIRECT, INCIDENTAL, SPECIAL, EXEMPLARY, OR CONSEQUENTIAL DAMAGES (INCLUDING, BUT NOT LIMITED TO, PROCUREMENT OF SUBSTITUTE GOODS OR SERVICES; LOSS OF USE, DATA, OR PROFITS; OR BUSINESS INTERRUPTION) HOWEVER CAUSED AND ON ANY THEORY OF LIABILITY, WHETHER IN CONTRACT, STRICT LIABILITY, OR TORT (INCLUDING NEGLIGENCE OR OTHERWISE) ARISING IN ANY WAY OUT OF THE USE OF THIS SOFTWARE, EVEN IF ADVISED OF THE POSSIBILITY OF SUCH DAMAGE.

License for libxml2 and libxslt

The following license refers to the XML parser and toolkit libraries used in Pulse Secure Virtual Traffic Manager, as licensed under the MIT License:

libxml2 2.9.12

libxslt 1.1.34

Licence for libxml2

Except where otherwise noted in the source code (e.g. the files hash.c, list.c and the trio files, which are covered by a similar licence but with different Copyright notices) all the files are:

Copyright (C) 1998-2012 Daniel Veillard. All Rights Reserved.

Permission is hereby granted, free of charge, to any person obtaining a copy of this software and associated documentation files (the "Software"), to deal in the Software without restriction, including without limitation the rights to use, copy, modify, merge, publish, distribute, sublicense, and/or sell copies of the Software, and to permit persons to whom the Software is furnished to do so, subject to the following conditions:

The above copyright notice and this permission notice shall be included in all copies or substantial portions of the Software.

THE SOFTWARE IS PROVIDED "AS IS", WITHOUT WARRANTY OF ANY KIND, EXPRESS OR IMPLIED, INCLUDING BUT NOT LIMITED TO THE WARRANTIES OF MERCHANTABILITY, FITNESS FOR A PARTICULAR PURPOSE AND NONINFRINGEMENT. IN NO EVENT SHALL THE AUTHORS OR COPYRIGHT HOLDERS BE LIABLE FOR ANY CLAIM, DAMAGES OR OTHER LIABILITY, WHETHER IN AN ACTION OF CONTRACT, TORT OR OTHERWISE, ARISING FROM, OUT OF OR IN CONNECTION WITH THE SOFTWARE OR THE USE OR OTHER DEALINGS IN THE SOFTWARE.

Licence for libxslt except libxslt

Copyright (C) 2001-2002 Daniel Veillard. All Rights Reserved.

Permission is hereby granted, free of charge, to any person obtaining a copy of this software and associated documentation files (the "Software"), to deal in the Software without restriction, including without limitation the rights to use, copy, modify, merge, publish, distribute, sublicense, and/or sell copies of the Software, and to permit persons to whom the Software is furnished to do so, subject to the following conditions:

The above copyright notice and this permission notice shall be included in all copies or substantial portions of the Software.

THE SOFTWARE IS PROVIDED "AS IS", WITHOUT WARRANTY OF ANY KIND, EXPRESS OR IMPLIED, INCLUDING BUT NOT LIMITED TO THE WARRANTIES OF MERCHANTABILITY, FITNESS FOR A PARTICULAR PURPOSE AND NONINFRINGEMENT. IN NO EVENT SHALL THE AUTHORS OR COPYRIGHT HOLDERS BE LIABLE FOR ANY CLAIM, DAMAGES OR OTHER LIABILITY, WHETHER IN AN ACTION OF CONTRACT, TORT OR OTHERWISE, ARISING FROM, OUT OF OR IN CONNECTION WITH THE SOFTWARE OR THE USE OR OTHER DEALINGS IN THE SOFTWARE.

Except as contained in this notice, the name of Daniel Veillard shall not be used in advertising or otherwise to promote the sale, use or other dealings in this Software without prior written authorization from him.

Licence for libexslt

Copyright (C) 2001-2002 Thomas Broyer, Charlie Bozeman and Daniel Veillard.

All Rights Reserved.

Permission is hereby granted, free of charge, to any person obtaining a copy of this software and associated documentation files (the "Software"), to deal in the Software without restriction, including without limitation the rights to use, copy, modify, merge, publish, distribute, sublicense, and/or sell copies of the Software, and to permit persons to whom the Software is furnished to do so, subject to the following conditions:

The above copyright notice and this permission notice shall be included in all copies or substantial portions of the Software.

THE SOFTWARE IS PROVIDED "AS IS", WITHOUT WARRANTY OF ANY KIND, EXPRESS OR IMPLIED, INCLUDING BUT NOT LIMITED TO THE WARRANTIES OF MERCHANTABILITY, FITNESS FOR A PARTICULAR PURPOSE AND NONINFRINGEMENT. IN NO EVENT SHALL THE AUTHORS BE LIABLE FOR ANY CLAIM, DAMAGES OR OTHER LIABILITY, WHETHER IN AN ACTION OF CONTRACT, TORT OR OTHERWISE, ARISING FROM, OUT OF OR IN CONNECTION WITH THE SOFTWARE OR THE USE OR OTHER DEALINGS IN THE SOFTWARE.

Except as contained in this notice, the name of the authors shall not be used in advertising or otherwise to promote the sale, use or other dealings in this Software without prior written authorization from him.

License for the Java Servlet API

The Java Servlet API used in Pulse Secure Virtual Traffic Manager contains code from the Apache Jakarta Project, and is licensed under the ASF license version 2.0:

Copyright 1999-2007, The Apache Software Foundation

Licensed under the Apache License, Version 2.0 (the "License"); you may not use this file except in compliance with the License. You may obtain a copy of the License at <http://www.apache.org/licenses/LICENSE-2.0>

Unless required by applicable law or agreed to in writing, software distributed under the License is distributed on an "AS IS" BASIS, WITHOUT WARRANTIES OR CONDITIONS OF ANY KIND, either express or implied. See the License for the specific language governing permissions and limitations under the License.

License for the Expat XML Parser

The following license refers to the expat XML parser library used in Pulse Secure Virtual Traffic Manager:

expat 2.2.8

Copyright (c) 1998 - 2000 Thai Open Source Software Center Ltd and Clark Cooper

Copyright (c) 2001 - 2017 Expat maintainers.

Permission is hereby granted, free of charge, to any person obtaining a copy of this software and associated documentation files (the "Software"), to deal in the Software without restriction, including without limitation the rights to use, copy, modify, merge, publish, distribute, sublicense, and/or sell copies of the Software, and to permit persons to whom the Software is furnished to do so, subject to the following conditions:

The above copyright notice and this permission notice shall be included in all copies or substantial portions of the Software.

THE SOFTWARE IS PROVIDED "AS IS", WITHOUT WARRANTY OF ANY KIND, EXPRESS OR IMPLIED, INCLUDING BUT NOT LIMITED TO THE WARRANTIES OF MERCHANTABILITY, FITNESS FOR A PARTICULAR PURPOSE AND NONINFRINGEMENT. IN NO EVENT SHALL THE AUTHORS OR COPYRIGHT HOLDERS BE LIABLE FOR ANY CLAIM, DAMAGES OR OTHER LIABILITY, WHETHER IN AN ACTION OF CONTRACT, TORT OR OTHERWISE, ARISING FROM, OUT OF OR IN CONNECTION WITH THE SOFTWARE OR THE USE OR OTHER DEALINGS IN THE SOFTWARE.

License for MooTools

Pulse Secure Virtual Traffic Manager contains code from the MooTools JavaScript framework, licensed under the open source MIT license:

MooTools 1.2

Copyright (c) 2006-2009 Valerio Proietti

Permission is hereby granted, free of charge, to any person obtaining a copy of this software and associated documentation files (the "Software"), to deal in the Software without restriction, including without limitation the rights to use, copy, modify, merge, publish, distribute, sublicense, and/or sell copies of the Software, and to permit persons to whom the Software is furnished to do so, subject to the following conditions:

The above copyright notice and this permission notice shall be included in all copies or substantial portions of the Software.

THE SOFTWARE IS PROVIDED "AS IS", WITHOUT WARRANTY OF ANY KIND, EXPRESS OR IMPLIED, INCLUDING BUT NOT LIMITED TO THE WARRANTIES OF MERCHANTABILITY, FITNESS FOR A PARTICULAR PURPOSE AND NONINFRINGEMENT. IN NO EVENT SHALL THE AUTHORS OR COPYRIGHT HOLDERS BE LIABLE FOR ANY CLAIM, DAMAGES OR OTHER LIABILITY, WHETHER IN AN ACTION OF CONTRACT, TORT OR OTHERWISE, ARISING FROM, OUT OF OR IN CONNECTION WITH THE SOFTWARE OR THE USE OR OTHER DEALINGS IN THE SOFTWARE.

Licenses for OpenLayers

Pulse Secure Virtual Traffic Manager contains code from MetaCarta, Rico and XMLHttpRequest.js. The following copyright notices apply:

Copyright (c) 2005-2008 MetaCarta, Inc.

All rights reserved.

Redistribution and use in source and binary forms, with or without modification, are permitted (subject to the limitations in the disclaimer below) provided that the following conditions are met:

- Redistributions of source code must retain the above copyright notice, this list of conditions and the following disclaimer.
- Redistributions in binary form must reproduce the above copyright notice, this list of conditions and the following disclaimer in the documentation and/or other materials provided with the distribution.
- Neither the name of MetaCarta, Inc. nor the names of its contributors may be used to endorse or promote products derived from this software without specific prior written permission.

NO EXPRESS OR IMPLIED LICENSES TO ANY PARTY'S PATENT RIGHTS ARE GRANTED BY THIS LICENSE. THIS SOFTWARE IS PROVIDED BY THE COPYRIGHT HOLDERS AND CONTRIBUTORS "AS IS" AND ANY EXPRESS OR IMPLIED WARRANTIES, INCLUDING, BUT NOT LIMITED TO, THE IMPLIED WARRANTIES OF MERCHANTABILITY AND FITNESS FOR A PARTICULAR PURPOSE ARE DISCLAIMED. IN NO EVENT SHALL THE COPYRIGHT OWNER OR CONTRIBUTORS BE LIABLE FOR ANY DIRECT, INDIRECT, INCIDENTAL, SPECIAL, EXEMPLARY, OR CONSEQUENTIAL DAMAGES (INCLUDING, BUT NOT LIMITED TO, PROCUREMENT OF SUBSTITUTE GOODS OR SERVICES; LOSS OF USE, DATA, OR PROFITS; OR BUSINESS INTERRUPTION) HOWEVER CAUSED AND ON ANY THEORY OF LIABILITY, WHETHER IN CONTRACT, STRICT LIABILITY, OR TORT (INCLUDING NEGLIGENCE OR OTHERWISE) ARISING IN ANY WAY OUT OF THE USE OF THIS SOFTWARE, EVEN IF ADVISED OF THE POSSIBILITY OF SUCH DAMAGE.

Contains portions of Rico <<http://openrico.org/>>

Copyright 2005 Sabre Airline Solutions

Licensed under the Apache License, Version 2.0 (the "License"); you may not use this file except in compliance with the License. You may obtain a copy of the License at:

<http://www.apache.org/licenses/LICENSE-2.0>

Unless required by applicable law or agreed to in writing, software distributed under the License is distributed on an "AS IS" BASIS, WITHOUT WARRANTIES OR CONDITIONS OF ANY KIND, either express or implied. See the License for the specific language governing permissions and limitations under the License.

Contains XMLHttpRequest.js <<http://code.google.com/p/xmlhttprequest/>>

Copyright 2007 Sergey Ilinsky (<http://www.ilinsky.com>)

Licensed under the Apache License, Version 2.0 (the "License"); you may not use this file except in compliance with the License. You may obtain a copy of the License at:

<http://www.apache.org/licenses/LICENSE-2.0>

License for rsync

Pulse Secure Virtual Traffic Manager contains code from rsync – a fast remote file copy program. The following copyright notice applies:

Version: 2.6.9

License summary: GPL v2

Copyright:

rsync was originally written by Andrew Tridgell and has been improved by many developers around the world. rsync may be used, modified and redistributed only under the terms of the GNU General Public License, found at: <http://www.fsf.org/licenses/old-licenses/gpl-2.0.html>

License for mod_imap.c

Pulse Secure Virtual Traffic Manager contains code from mod_imap.c, which originates from the Apache HTTP Server (<http://httpd.apache.org>) and is licensed under version 1.1 of the Apache Software License. The following copyright notice applies:

The Apache Software License, Version 1.1

Copyright (c) 2000 The Apache Software Foundation. All rights reserved.

Redistribution and use in source and binary forms, with or without modification, are permitted provided that the following conditions are met:

1. Redistributions of source code must retain the above copyright notice, this list of conditions and the following disclaimer.
2. Redistributions in binary form must reproduce the above copyright notice, this list of conditions and the following disclaimer in the documentation and/or other materials provided with the distribution.
3. The end-user documentation included with the redistribution, if any, must include the following acknowledgment:

"This product includes software developed by the Apache Software Foundation (<http://www.apache.org/>)."

Alternately, this acknowledgment may appear in the software itself, if and wherever such third-party acknowledgments normally appear.

4. The names "Apache" and "Apache Software Foundation" must not be used to endorse or promote products derived from this software without prior written permission. For written permission, please contact apache@apache.org.
5. Products derived from this software may not be called "Apache", nor may "Apache" appear in their name, without prior written permission of the Apache Software Foundation.

THIS SOFTWARE IS PROVIDED "AS IS" AND ANY EXPRESSED OR IMPLIED WARRANTIES, INCLUDING, BUT NOT LIMITED TO, THE IMPLIED WARRANTIES OF MERCHANTABILITY AND FITNESS FOR A PARTICULAR PURPOSE ARE DISCLAIMED. IN NO EVENT SHALL THE APACHE SOFTWARE FOUNDATION OR ITS CONTRIBUTORS BE LIABLE FOR ANY DIRECT, INDIRECT, INCIDENTAL, SPECIAL, EXEMPLARY, OR CONSEQUENTIAL DAMAGES (INCLUDING, BUT NOT LIMITED TO, PROCUREMENT OF SUBSTITUTE GOODS OR SERVICES; LOSS OF USE, DATA, OR PROFITS; OR BUSINESS INTERRUPTION) HOWEVER CAUSED AND ON ANY THEORY OF LIABILITY, WHETHER IN CONTRACT, STRICT LIABILITY, OR TORT (INCLUDING NEGLIGENCE OR OTHERWISE) ARISING IN ANY WAY OUT OF THE USE OF THIS SOFTWARE, EVEN IF ADVISED OF THE POSSIBILITY OF SUCH DAMAGE.

License for Antlr and libantlr

Pulse Secure Virtual Traffic Manager contains code from Antlr and libantlr – a JavaScript lexer generator and runtime library. The following copyright notice applies:

Version: 3.4

License summary: BSD

Copyright:

Copyright (c) 2005-2009 Jim Idle, Temporal Wave LLC

<http://www.temporal-wave.com>

<http://www.linkedin.com/in/jimidle>

All rights reserved.

Redistribution and use in source and binary forms, with or without modification, are permitted provided that the following conditions are met:

1. Redistributions of source code must retain the above copyright notice, this list of conditions and the following disclaimer.
2. Redistributions in binary form must reproduce the above copyright notice, this list of conditions and the following disclaimer in the documentation and/or other materials provided with the distribution.
3. The name of the author may not be used to endorse or promote products derived from this software without specific prior written permission.

THIS SOFTWARE IS PROVIDED BY THE AUTHOR ``AS IS'' AND ANY EXPRESS OR IMPLIED WARRANTIES, INCLUDING, BUT NOT LIMITED TO, THE IMPLIED WARRANTIES OF MERCHANTABILITY AND FITNESS FOR A PARTICULAR PURPOSE ARE DISCLAIMED. IN NO EVENT SHALL THE AUTHOR BE LIABLE FOR ANY DIRECT, INDIRECT, INCIDENTAL, SPECIAL, EXEMPLARY, OR CONSEQUENTIAL DAMAGES (INCLUDING, BUT NOT LIMITED TO, PROCUREMENT OF SUBSTITUTE GOODS OR SERVICES; LOSS OF USE, DATA, OR PROFITS; OR BUSINESS INTERRUPTION) HOWEVER CAUSED AND ON ANY THEORY OF LIABILITY, WHETHER IN CONTRACT, STRICT LIABILITY, OR TORT (INCLUDING NEGLIGENCE OR OTHERWISE) ARISING IN ANY WAY OUT OF THE USE OF THIS SOFTWARE, EVEN IF ADVISED OF THE POSSIBILITY OF SUCH DAMAGE.

License for es3-grammar

Pulse Secure Virtual Traffic Manager contains code generated using es3-grammar – a complete ECMAScript 3 grammar for ANTLR 3. The following copyright notice applies:

Version: N/A

License summary: BSD

Copyright:

Copyright (c) 2008-2010, Xebic Research B.V. All rights reserved.

Redistribution and use in source and binary forms, with or without modification, are permitted provided that the following conditions are met:

1. Redistributions of source code must retain the above copyright notice, this list of conditions and the following disclaimer.
2. Redistributions in binary form must reproduce the above copyright notice, this list of conditions and the following disclaimer in the documentation and/or other materials provided with the distribution.
3. The name of the author may not be used to endorse or promote products derived from this software without specific prior written permission.

THIS SOFTWARE IS PROVIDED BY THE AUTHOR ``AS IS'' AND ANY EXPRESS OR IMPLIED WARRANTIES, INCLUDING, BUT NOT LIMITED TO, THE IMPLIED WARRANTIES OF MERCHANTABILITY AND FITNESS FOR A PARTICULAR PURPOSE ARE DISCLAIMED. IN NO EVENT SHALL THE AUTHOR BE LIABLE FOR ANY DIRECT, INDIRECT, INCIDENTAL, SPECIAL, EXEMPLARY, OR CONSEQUENTIAL DAMAGES (INCLUDING, BUT NOT LIMITED TO, PROCUREMENT OF SUBSTITUTE GOODS OR SERVICES; LOSS OF USE, DATA, OR PROFITS; OR BUSINESS INTERRUPTION) HOWEVER CAUSED AND ON ANY THEORY OF LIABILITY, WHETHER IN CONTRACT, STRICT LIABILITY, OR TORT (INCLUDING NEGLIGENCE OR OTHERWISE) ARISING IN ANY WAY OUT OF THE USE OF THIS SOFTWARE, EVEN IF ADVISED OF THE POSSIBILITY OF SUCH DAMAGE.

License for jsoncpp

Pulse Secure Virtual Traffic Manager contains code from jsoncpp – a JSON library used for parsing config files. The following copyright notice applies:

Version: 0.5.0

License summary: MIT

Copyright:

Copyright (c) 2007-2010 Baptiste Lepilleur

Permission is hereby granted, free of charge, to any person obtaining a copy of this software and associated documentation files (the "Software"), to deal in the Software without restriction, including without limitation the rights to use, copy, modify, merge, publish, distribute, sublicense, and/or sell copies of the Software, and to permit persons to whom the Software is furnished to do so, subject to the following conditions:

The above copyright notice and this permission notice shall be included in all copies or substantial portions of the Software.

THE SOFTWARE IS PROVIDED "AS IS", WITHOUT WARRANTY OF ANY KIND, EXPRESS OR IMPLIED, INCLUDING BUT NOT LIMITED TO THE WARRANTIES OF MERCHANTABILITY, FITNESS FOR A PARTICULAR PURPOSE AND NONINFRINGEMENT. IN NO EVENT SHALL THE AUTHORS OR COPYRIGHT HOLDERS BE LIABLE FOR ANY CLAIM, DAMAGES OR OTHER LIABILITY, WHETHER IN AN ACTION OF CONTRACT, TORT OR OTHERWISE, ARISING FROM, OUT OF OR IN CONNECTION WITH THE SOFTWARE OR THE USE OR OTHER DEALINGS IN THE SOFTWARE.

License for libjpeg

Pulse Secure Virtual Traffic Manager contains code from libjpeg – a JPEG manipulation library. The following copyright notice applies:

Version: 9c

License summary: IJG license

Copyright:

The authors make NO WARRANTY or representation, either express or implied, with respect to this software, its quality, accuracy, merchantability, or fitness for a particular purpose. This software is provided "AS IS", and you, its user, assume the entire risk as to its quality and accuracy.

This software is copyright (C) 1991-2018, Thomas G. Lane, Guido Vollbeding. All Rights Reserved except as specified below.

Permission is hereby granted to use, copy, modify, and distribute this software (or portions thereof) for any purpose, without fee, subject to these conditions:

1. If any part of the source code for this software is distributed, then this README file must be included, with this copyright and no-warranty notice unaltered; and any additions, deletions, or changes to the original files must be clearly indicated in accompanying documentation.
2. If only executable code is distributed, then the accompanying documentation must state that "this software is based in part on the work of the Independent JPEG Group".
3. Permission for use of this software is granted only if the user accepts full responsibility for any undesirable consequences; the authors accept NO LIABILITY for damages of any kind.

These conditions apply to any software derived from or based on the IJG code, not just to the unmodified library. If you use our work, you ought to acknowledge us.

Permission is NOT granted for the use of any IJG author's name or company name in advertising or publicity relating to this software or products derived from it. This software may be referred to only as "the Independent JPEG Group's software".

We specifically permit and encourage the use of this software as the basis of commercial products, provided that all warranty or liability claims are assumed by the product vendor.

The Unix configuration script "configure" was produced with GNU Autoconf. It is copyright by the Free Software Foundation but is freely distributable. The same holds for its supporting scripts (config.guess, config.sub, ltmain.sh). Another support script, install-sh, is copyright by X Consortium but is also freely distributable.

The IJG distribution formerly included code to read and write GIF files. To avoid entanglement with the Unisys LZW patent (now expired), GIF reading support has been removed altogether, and the GIF writer has been simplified to produce "uncompressed GIFs". This technique does not use the LZW algorithm; the resulting GIF files are larger than usual, but are readable by all standard GIF decoders.

License for libunwind

Pulse Secure Virtual Traffic Manager contains code from libunwind – a stack unwinding library. The following copyright notice applies:

Version: 1.1

License summary: MIT

Copyright:

Permission is hereby granted, free of charge, to any person obtaining a copy of this software and associated documentation files (the "Software"), to deal in the Software without restriction, including without limitation the rights to use, copy, modify, merge, publish, distribute, sublicense, and/or sell copies of the Software, and to permit persons to whom the Software is furnished to do so, subject to the following conditions:

The above copyright notice and this permission notice shall be included in all copies or substantial portions of the Software.

THE SOFTWARE IS PROVIDED "AS IS", WITHOUT WARRANTY OF ANY KIND, EXPRESS OR IMPLIED, INCLUDING BUT NOT LIMITED TO THE WARRANTIES OF MERCHANTABILITY, FITNESS FOR A PARTICULAR PURPOSE AND NONINFRINGEMENT. IN NO EVENT SHALL THE AUTHORS OR COPYRIGHT HOLDERS BE LIABLE FOR ANY CLAIM, DAMAGES OR OTHER LIABILITY, WHETHER IN AN ACTION OF CONTRACT, TORT OR OTHERWISE, ARISING FROM, OUT OF OR IN CONNECTION WITH THE SOFTWARE OR THE USE OR OTHER DEALINGS IN THE SOFTWARE.

License for the Perl JSON Library

Pulse Secure Virtual Traffic Manager contains code from the Perl JSON library – a Perl module for JSON (JavaScript Object Notation) encoding and decoding. The following copyright notice applies:

Version: 2.53

License summary: Perl Artistic License v.1

Copyright:

Preamble

The intent of this document is to state the conditions under which a Package may be copied, such that the Copyright Holder maintains some semblance of artistic control over the development of the package, while giving the users of the package the right to use and distribute the Package in a more-or-less customary fashion, plus the right to make reasonable modifications.

Definitions:

"Package" refers to the collection of files distributed by the Copyright Holder, and derivatives of that collection of files created through textual modification.

"Standard Version" refers to such a Package if it has not been modified, or has been modified in accordance with the wishes of the Copyright Holder as specified below.

"Copyright Holder" is whoever is named in the copyright or copyrights for the package.

"You" is you, if you're thinking about copying or distributing this Package.

"Reasonable copying fee" is whatever you can justify on the basis of media cost, duplication charges, time of people involved, and so on. (You will not be required to justify it to the Copyright Holder, but only to the computing community at large as a market that must bear the fee.)

"Freely Available" means that no fee is charged for the item itself, though there may be fees involved in handling the item. It also means that recipients of the item may redistribute it under the same conditions they received it.

1. You may make and give away verbatim copies of the source form of the Standard Version of this Package without restriction, provided that you duplicate all of the original copyright notices and associated disclaimers.
2. You may apply bug fixes, portability fixes and other modifications derived from the Public Domain or from the Copyright Holder. A Package modified in such a way shall still be considered the Standard Version.
3. You may otherwise modify your copy of this Package in any way, provided that you insert a prominent notice in each changed file stating how and when you changed that file, and provided that you do at least ONE of the following:

- a) place your modifications in the Public Domain or otherwise make them Freely Available, such as by posting said modifications to Usenet or an equivalent medium, or placing the modifications on a major archive site such as uunet.uu.net, or by allowing the Copyright Holder to include your modifications in the Standard Version of the Package.
 - b) use the modified Package only within your corporation or organization.
 - c) rename any non-standard executables so the names do not conflict with standard executables, which must also be provided, and provide a separate manual page for each non-standard executable that clearly documents how it differs from the Standard Version.
 - d) make other distribution arrangements with the Copyright Holder.
4. You may distribute the programs of this Package in object code or executable form, provided that you do at least ONE of the following:
- a) distribute a Standard Version of the executables and library files, together with instructions (in the manual page or equivalent) on where to get the Standard Version.
 - b) accompany the distribution with the machine-readable source of the Package with your modifications.
 - c) give non-standard executables non-standard names, and clearly document the differences in manual pages (or equivalent), together with instructions on where to get the Standard Version.
 - d) make other distribution arrangements with the Copyright Holder.
5. You may charge a reasonable copying fee for any distribution of this Package. You may charge any fee you choose for support of this Package. You may not charge a fee for this Package itself. However, you may distribute this Package in aggregate with other (possibly commercial) programs as part of a larger (possibly commercial) software distribution provided that you do not advertise this Package as a product of your own. You may embed this Package's interpreter within an executable of yours (by linking); this shall be construed as a mere form of aggregation, provided that the complete Standard Version of the interpreter is so embedded.

6. The scripts and library files supplied as input to or produced as output from the programs of this Package do not automatically fall under the copyright of this Package, but belong to whoever generated them, and may be sold commercially, and may be aggregated with this Package. If such scripts or library files are aggregated with this Package via the so-called "undump" or "unexec" methods of producing a binary executable image, then distribution of such an image shall neither be construed as a distribution of this Package nor shall it fall under the restrictions of Paragraphs 3 and 4, provided that you do not represent such an executable image as a Standard Version of this Package.
7. C subroutines (or comparably compiled subroutines in other languages) supplied by you and linked into this Package in order to emulate subroutines and variables of the language defined by this Package shall not be considered part of this Package, but are the equivalent of input as in Paragraph 6, provided these subroutines do not change the language in any way that would cause it to fail the regression tests for the language.
8. Aggregation of this Package with a commercial distribution is always permitted provided that the use of this Package is embedded; that is, when no overt attempt is made to make this Package's interfaces visible to the end user of the commercial distribution. Such use shall not be construed as a distribution of this Package.
9. The name of the Copyright Holder may not be used to endorse or promote products derived from this software without specific prior written permission.
10. THIS PACKAGE IS PROVIDED "AS IS" AND WITHOUT ANY EXPRESS OR IMPLIED WARRANTIES, INCLUDING, WITHOUT LIMITATION, THE IMPLIED WARRANTIES OF MERCHANTABILITY AND FITNESS FOR A PARTICULAR PURPOSE.

License for OpenSSL

Pulse Secure Virtual Traffic Manager contains code from the OpenSSL library – a cryptography and SSL/TLS toolkit. The following copyright notice applies:

Versions: 1.0.2q / 1.1.1j

License summary: BSD-style

Copyright notice:

LICENSE ISSUES

The OpenSSL toolkit stays under a double license, i.e. both the conditions of the OpenSSL License and the original SSLeay license apply to the toolkit. See below for the actual license texts. Actually both licenses are BSD-style Open Source licenses. In case of any license issues related to OpenSSL please contact openssl-core@openssl.org.

OpenSSL License

Copyright (c) 1998-2019 The OpenSSL Project. All rights reserved.

Redistribution and use in source and binary forms, with or without modification, are permitted provided that the following conditions are met:

1. Redistributions of source code must retain the above copyright notice, this list of conditions and the following disclaimer.
2. Redistributions in binary form must reproduce the above copyright notice, this list of conditions and the following disclaimer in the documentation and/or other materials provided with the distribution.
3. All advertising materials mentioning features or use of this software must display the following acknowledgment:
"This product includes software developed by the OpenSSL Project for use in the OpenSSL Toolkit. (<http://www.openssl.org/>)"
4. The names "OpenSSL Toolkit" and "OpenSSL Project" must not be used to endorse or promote products derived from this software without prior written permission. For written permission, please contact openssl-core@openssl.org.
5. Products derived from this software may not be called "OpenSSL" nor may "OpenSSL" appear in their names without prior written permission of the OpenSSL Project.
6. Redistributions of any form whatsoever must retain the following acknowledgment:
"This product includes software developed by the OpenSSL Project for use in the OpenSSL Toolkit (<http://www.openssl.org/>)"

THIS SOFTWARE IS PROVIDED BY THE OpenSSL PROJECT "AS IS" AND ANY EXPRESSED OR IMPLIED WARRANTIES, INCLUDING, BUT NOT LIMITED TO, THE IMPLIED WARRANTIES OF MERCHANTABILITY AND FITNESS FOR A PARTICULAR PURPOSE ARE DISCLAIMED. IN NO EVENT SHALL THE OpenSSL PROJECT OR ITS CONTRIBUTORS BE LIABLE FOR ANY DIRECT, INDIRECT, INCIDENTAL, SPECIAL, EXEMPLARY, OR CONSEQUENTIAL DAMAGES (INCLUDING, BUT NOT LIMITED TO, PROCUREMENT OF SUBSTITUTE GOODS OR SERVICES; LOSS OF USE, DATA, OR PROFITS; OR BUSINESS INTERRUPTION) HOWEVER CAUSED AND ON ANY THEORY OF LIABILITY, WHETHER IN CONTRACT, STRICT LIABILITY, OR TORT (INCLUDING NEGLIGENCE OR OTHERWISE) ARISING IN ANY WAY OUT OF THE USE OF THIS SOFTWARE, EVEN IF ADVISED OF THE POSSIBILITY OF SUCH DAMAGE.

=====
==

This product includes cryptographic software written by Eric Young (ey@cryptsoft.com). This product includes software written by Tim Hudson (tjh@cryptsoft.com).

Original SSLeay License

Copyright (C) 1995-1998 Eric Young (ey@cryptsoft.com)

All rights reserved.

This package is an SSL implementation written by Eric Young (ey@cryptsoft.com). The implementation was written so as to conform with Netscape's SSL.

This library is free for commercial and non-commercial use as long as the following conditions are aheared to. The following conditions apply to all code found in this distribution, be it the RC4, RSA, lhash, DES, etc., code; not just the SSL code. The SSL documentation included with this distribution is covered by the same copyright terms except that the holder is Tim Hudson (tjh@cryptsoft.com).

Copyright remains Eric Young's, and as such any Copyright notices in the code are not to be removed. If this package is used in a product, Eric Young should be given attribution as the author of the parts of the library used. This can be in the form of a textual message at program startup or in documentation (online or textual) provided with the package.

Redistribution and use in source and binary forms, with or without modification, are permitted provided that the following conditions are met:

1. Redistributions of source code must retain the copyright notice, this list of conditions and the following disclaimer.

2. Redistributions in binary form must reproduce the above copyright notice, this list of conditions and the following disclaimer in the documentation and/or other materials provided with the distribution.
3. All advertising materials mentioning features or use of this software must display the following acknowledgement:
"This product includes cryptographic software written by Eric Young (eay@cryptsoft.com)"
The word 'cryptographic' can be left out if the routines from the library being used are not cryptographic related :-).
4. If you include any Windows specific code (or a derivative thereof) from the apps directory (application code) you must include an acknowledgement:
"This product includes software written by Tim Hudson (tjh@cryptsoft.com)"

THIS SOFTWARE IS PROVIDED BY ERIC YOUNG "AS IS" AND ANY EXPRESS OR IMPLIED WARRANTIES, INCLUDING, BUT NOT LIMITED TO, THE IMPLIED WARRANTIES OF MERCHANTABILITY AND FITNESS FOR A PARTICULAR PURPOSE ARE DISCLAIMED. IN NO EVENT SHALL THE AUTHOR OR CONTRIBUTORS BE LIABLE FOR ANY DIRECT, INDIRECT, INCIDENTAL, SPECIAL, EXEMPLARY, OR CONSEQUENTIAL DAMAGES (INCLUDING, BUT NOT LIMITED TO, PROCUREMENT OF SUBSTITUTE GOODS OR SERVICES; LOSS OF USE, DATA, OR PROFITS; OR BUSINESS INTERRUPTION) HOWEVER CAUSED AND ON ANY THEORY OF LIABILITY, WHETHER IN CONTRACT, STRICT LIABILITY, OR TORT (INCLUDING NEGLIGENCE OR OTHERWISE) ARISING IN ANY WAY OUT OF THE USE OF THIS SOFTWARE, EVEN IF ADVISED OF THE POSSIBILITY OF SUCH DAMAGE.

The licence and distribution terms for any publically available version or derivative of this code cannot be changed. i.e. this code cannot simply be copied and put under another distribution licence [including the GNU Public Licence.]

License for WebP

Pulse Secure Virtual Traffic Manager contains code from WebP – an image format with corresponding conversion library. The following copyright notice applies:

Version: 0.3.1

License summary: BSD-style

Copyright notice:

Copyright (c) 2010, Google Inc. All rights reserved.

Redistribution and use in source and binary forms, with or without modification, are permitted provided that the following conditions are met:

- Redistributions of source code must retain the above copyright notice, this list of conditions and the following disclaimer.
- Redistributions in binary form must reproduce the above copyright notice, this list of conditions and the following disclaimer in the documentation and/or other materials provided with the distribution.
- Neither the name of Google nor the names of its contributors may be used to endorse or promote products derived from this software without specific prior written permission.

THIS SOFTWARE IS PROVIDED BY THE COPYRIGHT HOLDERS AND CONTRIBUTORS "AS IS" AND ANY EXPRESS OR IMPLIED WARRANTIES, INCLUDING, BUT NOT LIMITED TO, THE IMPLIED WARRANTIES OF MERCHANTABILITY AND FITNESS FOR A PARTICULAR PURPOSE ARE DISCLAIMED. IN NO EVENT SHALL THE COPYRIGHT HOLDER OR CONTRIBUTORS BE LIABLE FOR ANY DIRECT, INDIRECT, INCIDENTAL, SPECIAL, EXEMPLARY, OR CONSEQUENTIAL DAMAGES (INCLUDING, BUT NOT LIMITED TO, PROCUREMENT OF SUBSTITUTE GOODS OR SERVICES; LOSS OF USE, DATA, OR PROFITS; OR BUSINESS INTERRUPTION) HOWEVER CAUSED AND ON ANY THEORY OF LIABILITY, WHETHER IN CONTRACT, STRICT LIABILITY, OR TORT (INCLUDING NEGLIGENCE OR OTHERWISE) ARISING IN ANY WAY OUT OF THE USE OF THIS SOFTWARE, EVEN IF ADVISED OF THE POSSIBILITY OF SUCH DAMAGE.

License for Flex

Pulse Secure Virtual Traffic Manager contains code generated through Flex – a fast lexical analyzer tool. The following copyright notice applies:

Version: 2.5.37

License summary: BSD-style

Copyright notice:

Flex carries the copyright used for BSD software, slightly modified because it originated at the Lawrence Berkeley (not Livermore!) Laboratory, which operates under a contract with the Department of Energy:

Copyright (c) 2001, 2002, 2003, 2004, 2005, 2006, 2007 The Flex Project.

Copyright (c) 1990, 1997 The Regents of the University of California.

All rights reserved.

This code is derived from software contributed to Berkeley by Vern Paxson.

The United States Government has rights in this work pursuant to contract no. DE-AC03-76SF00098 between the United States Department of Energy and the University of California.

Redistribution and use in source and binary forms, with or without modification, are permitted provided that the following conditions are met:

1. Redistributions of source code must retain the above copyright notice, this list of conditions and the following disclaimer.
2. Redistributions in binary form must reproduce the above copyright notice, this list of conditions and the following disclaimer in the documentation and/or other materials provided with the distribution.

Neither the name of the University nor the names of its contributors may be used to endorse or promote products derived from this software without specific prior written permission.

THIS SOFTWARE IS PROVIDED ``AS IS'' AND WITHOUT ANY EXPRESS OR IMPLIED WARRANTIES, INCLUDING, WITHOUT LIMITATION, THE IMPLIED WARRANTIES OF MERCHANTABILITY AND FITNESS FOR A PARTICULAR PURPOSE.

This basically says "do whatever you please with this software except remove this notice or take advantage of the University's (or the flex authors') name".

Note that the "flex.skl" scanner skeleton carries no copyright notice. You are free to do whatever you please with scanners generated using flex; for them, you are not even bound by the above copyright.

License for zlib

Pulse Secure Virtual Traffic Manager contains code from zlib – a compression library. The following copyright notice applies:

Version: 1.2.8

Copyright notice:

zlib.h -- interface of the 'zlib' general purpose compression library version 1.2.8, April 28th, 2013

Copyright (C) 1995-2013 Jean-loup Gailly and Mark Adler

This software is provided 'as-is', without any express or implied warranty. In no event will the authors be held liable for any damages arising from the use of this software.

Permission is granted to anyone to use this software for any purpose, including commercial applications, and to alter it and redistribute it freely, subject to the following restrictions:

1. The origin of this software must not be misrepresented; you must not claim that you wrote the original software. If you use this software in a product, an acknowledgment in the product documentation would be appreciated but is not required.
2. Altered source versions must be plainly marked as such, and must not be misrepresented as being the original software.
3. This notice may not be removed or altered from any source distribution.

Jean-loup Gailly Mark Adler

jloup@gzip.org madler@alumni.caltech.edu

License for XML::Twig

Pulse Secure Virtual Traffic Manager contains code from XML::Twig – a Perl library used for processing XML data. The following copyright notice applies:

Version: 3.48

License summary: Perl 5 License (Artistic 1 & GPL 1)

Copyright notice:

COPYRIGHT

Copyright (c) 1999-2012, Michel Rodriguez. All Rights Reserved.

This library is free software; you can redistribute it and/or modify it under the same terms as Perl itself.

License for MIT Kerberos

Pulse Secure Virtual Traffic Manager contains code from MIT Kerberos – a network authentication protocol. The following copyright notice applies:

Version: 1.18.3

License summary: MIT

Copyright notice:

Copyright (C) 1985-2020 by the Massachusetts Institute of Technology.

All rights reserved.

Redistribution and use in source and binary forms, with or without modification, are permitted provided that the following conditions are met:

- Redistributions of source code must retain the above copyright notice, this list of conditions and the following disclaimer.
- Redistributions in binary form must reproduce the above copyright notice, this list of conditions and the following disclaimer in the documentation and/or other materials provided with the distribution.

THIS SOFTWARE IS PROVIDED BY THE COPYRIGHT HOLDERS AND CONTRIBUTORS "AS IS" AND ANY EXPRESS OR IMPLIED WARRANTIES, INCLUDING, BUT NOT LIMITED TO, THE IMPLIED WARRANTIES OF MERCHANTABILITY AND FITNESS FOR A PARTICULAR PURPOSE ARE DISCLAIMED. IN NO EVENT SHALL THE COPYRIGHT HOLDER OR CONTRIBUTORS BE LIABLE FOR ANY DIRECT, INDIRECT, INCIDENTAL, SPECIAL, EXEMPLARY, OR CONSEQUENTIAL DAMAGES (INCLUDING, BUT NOT LIMITED TO, PROCUREMENT OF SUBSTITUTE GOODS OR SERVICES; LOSS OF USE, DATA, OR PROFITS; OR BUSINESS INTERRUPTION) HOWEVER CAUSED AND ON ANY THEORY OF LIABILITY, WHETHER IN CONTRACT, STRICT LIABILITY, OR TORT (INCLUDING NEGLIGENCE OR OTHERWISE) ARISING IN ANY WAY OUT OF THE USE OF THIS SOFTWARE, EVEN IF ADVISED OF THE POSSIBILITY OF SUCH DAMAGE.

Downloading of this software may constitute an export of cryptographic software from the United States of America that is subject to the United States Export Administration Regulations (EAR), 15 CFR 730-774. Additional laws or regulations may apply. It is the responsibility of the person or entity contemplating export to comply with all applicable export laws and regulations, including obtaining any required license from the U.S. government.

The U.S. government prohibits export of encryption source code to certain countries and individuals, including, but not limited to, the countries of Cuba, Iran, North Korea, Sudan, Syria, and residents and nationals of those countries.

Documentation components of this software distribution are licensed under a Creative Commons Attribution-ShareAlike 3.0 Unported License. (<http://creativecommons.org/licenses/by-sa/3.0/>)

Individual source code files are copyright MIT, Cygnus Support, Novell, OpenVision Technologies, Oracle, Red Hat, Sun Microsystems, FundsXpress, and others.

Project Athena, Athena, Athena MUSE, Discuss, Hesiod, Kerberos, Moira, and Zephyr are trademarks of the Massachusetts Institute of Technology (MIT). No commercial use of these trademarks may be made without prior written permission of MIT.

“Commercial use” means use of a name in a product or other for-profit manner. It does NOT prevent a commercial firm from referring to the MIT trademarks in order to convey information (although in doing so, recognition of their trademark status should be given).

The following copyright and permission notice applies to the OpenVision Kerberos Administration system located in kadmin/create, kadmin/dbutil, kadmin/passwd, kadmin/server, lib/kadm5, and portions of lib/rpc:

Copyright, OpenVision Technologies, Inc., 1993-1996, All Rights Reserved

WARNING: Retrieving the OpenVision Kerberos Administration system source code, as described below, indicates your acceptance of the following terms. If you do not agree to the following terms, do not retrieve the OpenVision Kerberos administration system.

You may freely use and distribute the Source Code and Object Code compiled from it, with or without modification, but this Source Code is provided to you “AS IS” EXCLUSIVE OF ANY WARRANTY, INCLUDING, WITHOUT LIMITATION, ANY WARRANTIES OF MERCHANTABILITY OR FITNESS FOR A PARTICULAR PURPOSE, OR ANY OTHER WARRANTY, WHETHER EXPRESS OR IMPLIED. IN NO EVENT WILL OPENVISION HAVE ANY LIABILITY FOR ANY LOST PROFITS, LOSS OF DATA OR COSTS OF PROCUREMENT OF SUBSTITUTE GOODS OR SERVICES, OR FOR ANY SPECIAL, INDIRECT, OR CONSEQUENTIAL DAMAGES ARISING OUT OF THIS AGREEMENT, INCLUDING, WITHOUT LIMITATION, THOSE RESULTING FROM THE USE OF THE SOURCE CODE, OR THE FAILURE OF THE SOURCE CODE TO PERFORM, OR FOR ANY OTHER REASON.

OpenVision retains all copyrights in the donated Source Code. OpenVision also retains copyright to derivative works of the Source Code, whether created by OpenVision or by a third party. The OpenVision copyright notice must be preserved if derivative works are made based on the donated Source Code.

OpenVision Technologies, Inc. has donated this Kerberos Administration system to MIT for inclusion in the standard Kerberos 5 distribution. This donation underscores our commitment to continuing Kerberos technology development and our gratitude for the valuable work which has been performed by MIT and the Kerberos community.

Portions contributed by Matt Crawford crawdad@fnal.gov were work performed at Fermi National Accelerator Laboratory, which is operated by Universities Research Association, Inc., under contract DE-AC02-76CHO3000 with the U.S. Department of Energy.

Portions of `src/lib/crypto` have the following copyright:

Copyright © 1998 by the FundsXpress, INC.

All rights reserved.

Export of this software from the United States of America may require a specific license from the United States Government. It is the responsibility of any person or organization contemplating export to obtain such a license before exporting.

WITHIN THAT CONSTRAINT, permission to use, copy, modify, and distribute this software and its documentation for any purpose and without fee is hereby granted, provided that the above copyright notice appear in all copies and that both that copyright notice and this permission notice appear in supporting documentation, and that the name of FundsXpress. not be used in advertising or publicity pertaining to distribution of the software without specific, written prior permission. FundsXpress makes no representations about the suitability of this software for any purpose. It is provided "as is" without express or implied warranty.

THIS SOFTWARE IS PROVIDED "AS IS" AND WITHOUT ANY EXPRESS OR IMPLIED WARRANTIES, INCLUDING, WITHOUT LIMITATION, THE IMPLIED WARRANTIES OF MERCHANTABILITY AND FITNESS FOR A PARTICULAR PURPOSE.

The implementation of the AES encryption algorithm in `src/lib/crypto/builtin/aes` has the following copyright:

Copyright © 2001, Dr Brian Gladman brg@gladman.uk.net, Worcester, UK.

All rights reserved.

LICENSE TERMS

The free distribution and use of this software in both source and binary form is allowed (with or without changes) provided that:

1. distributions of this source code include the above copyright notice, this list of conditions and the following disclaimer;

2. distributions in binary form include the above copyright notice, this list of conditions and the following disclaimer in the documentation and/or other associated materials;
3. the copyright holder's name is not used to endorse products built using this software without specific written permission.

DISCLAIMER

This software is provided 'as is' with no explicit or implied warranties in respect of any properties, including, but not limited to, correctness and fitness for purpose.

Portions contributed by Red Hat, including the pre-authentication plug-in framework and the NSS crypto implementation, contain the following copyright:

Copyright © 2006 Red Hat, Inc.

Portions copyright © 2006 Massachusetts Institute of Technology

All Rights Reserved.

Redistribution and use in source and binary forms, with or without modification, are permitted provided that the following conditions are met:

- Redistributions of source code must retain the above copyright notice, this list of conditions and the following disclaimer.
- Redistributions in binary form must reproduce the above copyright notice, this list of conditions and the following disclaimer in the documentation and/or other materials provided with the distribution.
- Neither the name of Red Hat, Inc., nor the names of its contributors may be used to endorse or promote products derived from this software without specific prior written permission.

THIS SOFTWARE IS PROVIDED BY THE COPYRIGHT HOLDERS AND CONTRIBUTORS "AS IS" AND ANY EXPRESS OR IMPLIED WARRANTIES, INCLUDING, BUT NOT LIMITED TO, THE IMPLIED WARRANTIES OF MERCHANTABILITY AND FITNESS FOR A PARTICULAR PURPOSE ARE DISCLAIMED. IN NO EVENT SHALL THE COPYRIGHT OWNER OR CONTRIBUTORS BE LIABLE FOR ANY DIRECT, INDIRECT, INCIDENTAL, SPECIAL, EXEMPLARY, OR CONSEQUENTIAL DAMAGES (INCLUDING, BUT NOT LIMITED TO, PROCUREMENT OF SUBSTITUTE GOODS OR SERVICES; LOSS OF USE, DATA, OR PROFITS; OR BUSINESS INTERRUPTION) HOWEVER CAUSED AND ON ANY THEORY OF LIABILITY, WHETHER IN CONTRACT, STRICT LIABILITY, OR TORT (INCLUDING NEGLIGENCE OR OTHERWISE) ARISING IN ANY WAY OUT OF THE USE OF THIS SOFTWARE, EVEN IF ADVISED OF THE POSSIBILITY OF SUCH DAMAGE.

The bundled verto source code is subject to the following license:

Copyright 2011 Red Hat, Inc.

Permission is hereby granted, free of charge, to any person obtaining a copy of this software and associated documentation files (the "Software"), to deal in the Software without restriction, including without limitation the rights to use, copy, modify, merge, publish, distribute, sublicense, and/or sell copies of the Software, and to permit persons to whom the Software is furnished to do so, subject to the following conditions:

The above copyright notice and this permission notice shall be included in all copies or substantial portions of the Software.

THE SOFTWARE IS PROVIDED "AS IS", WITHOUT WARRANTY OF ANY KIND, EXPRESS OR IMPLIED, INCLUDING BUT NOT LIMITED TO THE WARRANTIES OF MERCHANTABILITY, FITNESS FOR A PARTICULAR PURPOSE AND NONINFRINGEMENT. IN NO EVENT SHALL THE AUTHORS OR COPYRIGHT HOLDERS BE LIABLE FOR ANY CLAIM, DAMAGES OR OTHER LIABILITY, WHETHER IN AN ACTION OF CONTRACT, TORT OR OTHERWISE, ARISING FROM, OUT OF OR IN CONNECTION WITH THE SOFTWARE OR THE USE OR OTHER DEALINGS IN THE SOFTWARE.

The MS-KKDCP client implementation has the following copyright:

Copyright 2013,2014 Red Hat, Inc.

Redistribution and use in source and binary forms, with or without modification, are permitted provided that the following conditions are met:

1. Redistributions of source code must retain the above copyright notice, this list of conditions and the following disclaimer.

2. Redistributions in binary form must reproduce the above copyright notice, this list of conditions and the following disclaimer in the documentation and/or other materials provided with the distribution.

THIS SOFTWARE IS PROVIDED BY THE COPYRIGHT HOLDERS AND CONTRIBUTORS "AS IS" AND ANY EXPRESS OR IMPLIED WARRANTIES, INCLUDING, BUT NOT LIMITED TO, THE IMPLIED WARRANTIES OF MERCHANTABILITY AND FITNESS FOR A PARTICULAR PURPOSE ARE DISCLAIMED. IN NO EVENT SHALL THE COPYRIGHT OWNER OR CONTRIBUTORS BE LIABLE FOR ANY DIRECT, INDIRECT, INCIDENTAL, SPECIAL, EXEMPLARY, OR CONSEQUENTIAL DAMAGES (INCLUDING, BUT NOT LIMITED TO, PROCUREMENT OF SUBSTITUTE GOODS OR SERVICES; LOSS OF USE, DATA, OR PROFITS; OR BUSINESS INTERRUPTION) HOWEVER CAUSED AND ON ANY THEORY OF LIABILITY, WHETHER IN CONTRACT, STRICT LIABILITY, OR TORT (INCLUDING NEGLIGENCE OR OTHERWISE) ARISING IN ANY WAY OUT OF THE USE OF THIS SOFTWARE, EVEN IF ADVISED OF THE POSSIBILITY OF SUCH DAMAGE.

The implementations of GSSAPI mechglue in GSSAPI-SPNEGO in src/lib/gssapi, including the following files:

lib/gssapi/generic/gssapi_err_generic.et
lib/gssapi/mechglue/g_accept_sec_context.c
lib/gssapi/mechglue/g_acquire_cred.c
lib/gssapi/mechglue/g_canon_name.c
lib/gssapi/mechglue/g_compare_name.c
lib/gssapi/mechglue/g_context_time.c
lib/gssapi/mechglue/g_delete_sec_context.c
lib/gssapi/mechglue/g_dsp_name.c
lib/gssapi/mechglue/g_dsp_status.c
lib/gssapi/mechglue/g_dup_name.c
lib/gssapi/mechglue/g_exp_sec_context.c
lib/gssapi/mechglue/g_export_name.c
lib/gssapi/mechglue/g_glue.c
lib/gssapi/mechglue/g_imp_name.c

lib/gssapi/mechglue/g_imp_sec_context.c
lib/gssapi/mechglue/g_init_sec_context.c
lib/gssapi/mechglue/g_initialize.c
lib/gssapi/mechglue/g_inquire_context.c
lib/gssapi/mechglue/g_inquire_cred.c
lib/gssapi/mechglue/g_inquire_names.c
lib/gssapi/mechglue/g_process_context.c
lib/gssapi/mechglue/g_rel_buffer.c
lib/gssapi/mechglue/g_rel_cred.c
lib/gssapi/mechglue/g_rel_name.c
lib/gssapi/mechglue/g_rel_oid_set.c
lib/gssapi/mechglue/g_seal.c
lib/gssapi/mechglue/g_sign.c
lib/gssapi/mechglue/g_store_cred.c
lib/gssapi/mechglue/g_unseal.c
lib/gssapi/mechglue/g_userok.c
lib/gssapi/mechglue/g_utils.c
lib/gssapi/mechglue/g_verify.c
lib/gssapi/mechglue/gssd_pname_to_uid.c
lib/gssapi/mechglue/mglueP.h
lib/gssapi/mechglue/oid_ops.c
lib/gssapi/spnego/gssapiP_spnego.h
lib/gssapi/spnego/spnego_mech.c

and the initial implementation of incremental propagation, including the following new or changed files:

include/ipropr_hdr.h

kadmin/server/ipropr_svc.c

lib/kdb/ipropr.x

lib/kdb/kdb_convert.c

lib/kdb/kdb_log.c

lib/kdb/kdb_log.h

lib/krb5/error_tables/kdb5_err.et

slave/kpropd_rpc.c

slave/kproplog.c

are subject to the following license:

Copyright © 2004 Sun Microsystems, Inc.

Permission is hereby granted, free of charge, to any person obtaining a copy of this software and associated documentation files (the "Software"), to deal in the Software without restriction, including without limitation the rights to use, copy, modify, merge, publish, distribute, sublicense, and/or sell copies of the Software, and to permit persons to whom the Software is furnished to do so, subject to the following conditions:

The above copyright notice and this permission notice shall be included in all copies or substantial portions of the Software.

THE SOFTWARE IS PROVIDED "AS IS", WITHOUT WARRANTY OF ANY KIND, EXPRESS OR IMPLIED, INCLUDING BUT NOT LIMITED TO THE WARRANTIES OF MERCHANTABILITY, FITNESS FOR A PARTICULAR PURPOSE AND NONINFRINGEMENT. IN NO EVENT SHALL THE AUTHORS OR COPYRIGHT HOLDERS BE LIABLE FOR ANY CLAIM, DAMAGES OR OTHER LIABILITY, WHETHER IN AN ACTION OF CONTRACT, TORT OR OTHERWISE, ARISING FROM, OUT OF OR IN CONNECTION WITH THE SOFTWARE OR THE USE OR OTHER DEALINGS IN THE SOFTWARE.

Kerberos V5 includes documentation and software developed at the University of California at Berkeley, which includes this copyright notice:

Copyright © 1983 Regents of the University of California.

All rights reserved.

Redistribution and use in source and binary forms, with or without modification, are permitted provided that the following conditions are met:

1. Redistributions of source code must retain the above copyright notice, this list of conditions and the following disclaimer.
2. Redistributions in binary form must reproduce the above copyright notice, this list of conditions and the following disclaimer in the documentation and/or other materials provided with the distribution.
3. Neither the name of the University nor the names of its contributors may be used to endorse or promote products derived from this software without specific prior written permission.

THIS SOFTWARE IS PROVIDED BY THE REGENTS AND CONTRIBUTORS "AS IS" AND ANY EXPRESS OR IMPLIED WARRANTIES, INCLUDING, BUT NOT LIMITED TO, THE IMPLIED WARRANTIES OF MERCHANTABILITY AND FITNESS FOR A PARTICULAR PURPOSE ARE DISCLAIMED. IN NO EVENT SHALL THE REGENTS OR CONTRIBUTORS BE LIABLE FOR ANY DIRECT, INDIRECT, INCIDENTAL, SPECIAL, EXEMPLARY, OR CONSEQUENTIAL DAMAGES (INCLUDING, BUT NOT LIMITED TO, PROCUREMENT OF SUBSTITUTE GOODS OR SERVICES; LOSS OF USE, DATA, OR PROFITS; OR BUSINESS INTERRUPTION) HOWEVER CAUSED AND ON ANY THEORY OF LIABILITY, WHETHER IN CONTRACT, STRICT LIABILITY, OR TORT (INCLUDING NEGLIGENCE OR OTHERWISE) ARISING IN ANY WAY OUT OF THE USE OF THIS SOFTWARE, EVEN IF ADVISED OF THE POSSIBILITY OF SUCH DAMAGE.

Portions contributed by Novell, Inc., including the LDAP database backend, are subject to the following license:

Copyright © 2004-2005, Novell, Inc.

All rights reserved.

Redistribution and use in source and binary forms, with or without modification, are permitted provided that the following conditions are met:

- Redistributions of source code must retain the above copyright notice, this list of conditions and the following disclaimer.
- Redistributions in binary form must reproduce the above copyright notice, this list of conditions and the following disclaimer in the documentation and/or other materials provided with the distribution.
- The copyright holder's name is not used to endorse or promote products derived from this software without specific prior written permission.

THIS SOFTWARE IS PROVIDED BY THE COPYRIGHT HOLDERS AND CONTRIBUTORS "AS IS" AND ANY EXPRESS OR IMPLIED WARRANTIES, INCLUDING, BUT NOT LIMITED TO, THE IMPLIED WARRANTIES OF MERCHANTABILITY AND FITNESS FOR A PARTICULAR PURPOSE ARE DISCLAIMED. IN NO EVENT SHALL THE COPYRIGHT OWNER OR CONTRIBUTORS BE LIABLE FOR ANY DIRECT, INDIRECT, INCIDENTAL, SPECIAL, EXEMPLARY, OR CONSEQUENTIAL DAMAGES (INCLUDING, BUT NOT LIMITED TO, PROCUREMENT OF SUBSTITUTE GOODS OR SERVICES; LOSS OF USE, DATA, OR PROFITS; OR BUSINESS INTERRUPTION) HOWEVER CAUSED AND ON ANY THEORY OF LIABILITY, WHETHER IN CONTRACT, STRICT LIABILITY, OR TORT (INCLUDING NEGLIGENCE OR OTHERWISE) ARISING IN ANY WAY OUT OF THE USE OF THIS SOFTWARE, EVEN IF ADVISED OF THE POSSIBILITY OF SUCH DAMAGE.

Portions funded by Sandia National Laboratory and developed by the University of Michigan's Center for Information Technology Integration, including the PKINIT implementation, are subject to the following license:

COPYRIGHT © 2006-2007

THE REGENTS OF THE UNIVERSITY OF MICHIGAN

ALL RIGHTS RESERVED

Permission is granted to use, copy, create derivative works and redistribute this software and such derivative works for any purpose, so long as the name of The University of Michigan is not used in any advertising or publicity pertaining to the use of distribution of this software without specific, written prior authorization. If the above copyright notice or any other identification of the University of Michigan is included in any copy of any portion of this software, then the disclaimer below must also be included.

THIS SOFTWARE IS PROVIDED AS IS, WITHOUT REPRESENTATION FROM THE UNIVERSITY OF MICHIGAN AS TO ITS FITNESS FOR ANY PURPOSE, AND WITHOUT WARRANTY BY THE UNIVERSITY OF MICHIGAN OF ANY KIND, EITHER EXPRESS OR IMPLIED, INCLUDING WITHOUT LIMITATION THE IMPLIED WARRANTIES OF MERCHANTABILITY AND FITNESS FOR A PARTICULAR PURPOSE. THE REGENTS OF THE UNIVERSITY OF MICHIGAN SHALL NOT BE LIABLE FOR ANY DAMAGES, INCLUDING SPECIAL, INDIRECT, INCIDENTAL, OR CONSEQUENTIAL DAMAGES, WITH RESPECT TO ANY CLAIM ARISING OUT OF OR IN CONNECTION WITH THE USE OF THE SOFTWARE, EVEN IF IT HAS BEEN OR IS HEREAFTER ADVISED OF THE POSSIBILITY OF SUCH DAMAGES.

The pkcs11.h file included in the PKINIT code has the following license:

Copyright 2006 g10 Code GmbH

Copyright 2006 Andreas Jellinghaus

This file is free software; as a special exception the author gives unlimited permission to copy and/or distribute it, with or without modifications, as long as this notice is preserved.

This file is distributed in the hope that it will be useful, but WITHOUT ANY WARRANTY, to the extent permitted by law; without even the implied warranty of MERCHANTABILITY or FITNESS FOR A PARTICULAR PURPOSE.

Portions contributed by Apple Inc. are subject to the following license:

Copyright 2004-2008 Apple Inc. All Rights Reserved.

Export of this software from the United States of America may require a specific license from the United States Government. It is the responsibility of any person or organization contemplating export to obtain such a license before exporting.

WITHIN THAT CONSTRAINT, permission to use, copy, modify, and distribute this software and its documentation for any purpose and without fee is hereby granted, provided that the above copyright notice appear in all copies and that both that copyright notice and this permission notice appear in supporting documentation, and that the name of Apple Inc. not be used in advertising or publicity pertaining to distribution of the software without specific, written prior permission. Apple Inc. makes no representations about the suitability of this software for any purpose. It is provided "as is" without express or implied warranty.

THIS SOFTWARE IS PROVIDED "AS IS" AND WITHOUT ANY EXPRESS OR IMPLIED WARRANTIES, INCLUDING, WITHOUT LIMITATION, THE IMPLIED WARRANTIES OF MERCHANTABILITY AND FITNESS FOR A PARTICULAR PURPOSE.

The implementations of UTF-8 string handling in src/util/support and src/lib/krb5/unicode are subject to the following copyright and permission notice:

The OpenLDAP Public License

Version 2.8, 17 August 2003

Redistribution and use of this software and associated documentation ("Software"), with or without modification, are permitted provided that the following conditions are met:

1. Redistributions in source form must retain copyright statements and notices,
2. Redistributions in binary form must reproduce applicable copyright statements and notices, this list of conditions, and the following disclaimer in the documentation and/or other materials provided with the distribution, and
3. Redistributions must contain a verbatim copy of this document.

The OpenLDAP Foundation may revise this license from time to time. Each revision is distinguished by a version number. You may use this Software under terms of this license revision or under the terms of any subsequent revision of the license.

THIS SOFTWARE IS PROVIDED BY THE OPENLDAP FOUNDATION AND ITS CONTRIBUTORS "AS IS" AND ANY EXPRESSED OR IMPLIED WARRANTIES, INCLUDING, BUT NOT LIMITED TO, THE IMPLIED WARRANTIES OF MERCHANTABILITY AND FITNESS FOR A PARTICULAR PURPOSE ARE DISCLAIMED. IN NO EVENT SHALL THE OPENLDAP FOUNDATION, ITS CONTRIBUTORS, OR THE AUTHOR(S) OR OWNER(S) OF THE SOFTWARE BE LIABLE FOR ANY DIRECT, INDIRECT, INCIDENTAL, SPECIAL, EXEMPLARY, OR CONSEQUENTIAL DAMAGES (INCLUDING, BUT NOT LIMITED TO, PROCUREMENT OF SUBSTITUTE GOODS OR SERVICES; LOSS OF USE, DATA, OR PROFITS; OR BUSINESS INTERRUPTION) HOWEVER CAUSED AND ON ANY THEORY OF LIABILITY, WHETHER IN CONTRACT, STRICT LIABILITY, OR TORT (INCLUDING NEGLIGENCE OR OTHERWISE) ARISING IN ANY WAY OUT OF THE USE OF THIS SOFTWARE, EVEN IF ADVISED OF THE POSSIBILITY OF SUCH DAMAGE.

The names of the authors and copyright holders must not be used in advertising or otherwise to promote the sale, use or other dealing in this Software without specific, written prior permission. Title to copyright in this Software shall at all times remain with copyright holders.

OpenLDAP is a registered trademark of the OpenLDAP Foundation.

Copyright 1999-2003 The OpenLDAP Foundation, Redwood City, California, USA. All Rights Reserved.
Permission to copy and distribute verbatim copies of this document is granted.

Marked test programs in src/lib/krb5/krb have the following copyright:

Copyright © 2006 Kungliga Tekniska Högskola

(Royal Institute of Technology, Stockholm, Sweden).

All rights reserved.

Redistribution and use in source and binary forms, with or without modification, are permitted provided that the following conditions are met:

1. Redistributions of source code must retain the above copyright notice, this list of conditions and the following disclaimer.
2. Redistributions in binary form must reproduce the above copyright notice, this list of conditions and the following disclaimer in the documentation and/or other materials provided with the distribution.
3. Neither the name of KTH nor the names of its contributors may be used to endorse or promote products derived from this software without specific prior written permission.

THIS SOFTWARE IS PROVIDED BY KTH AND ITS CONTRIBUTORS "AS IS" AND ANY EXPRESS OR IMPLIED WARRANTIES, INCLUDING, BUT NOT LIMITED TO, THE IMPLIED WARRANTIES OF MERCHANTABILITY AND FITNESS FOR A PARTICULAR PURPOSE ARE DISCLAIMED. IN NO EVENT SHALL KTH OR ITS CONTRIBUTORS BE LIABLE FOR ANY DIRECT, INDIRECT, INCIDENTAL, SPECIAL, EXEMPLARY, OR CONSEQUENTIAL DAMAGES (INCLUDING, BUT NOT LIMITED TO, PROCUREMENT OF SUBSTITUTE GOODS OR SERVICES; LOSS OF USE, DATA, OR PROFITS; OR BUSINESS INTERRUPTION) HOWEVER CAUSED AND ON ANY THEORY OF LIABILITY, WHETHER IN CONTRACT, STRICT LIABILITY, OR TORT (INCLUDING NEGLIGENCE OR OTHERWISE) ARISING IN ANY WAY OUT OF THE USE OF THIS SOFTWARE, EVEN IF ADVISED OF THE POSSIBILITY OF SUCH DAMAGE.

The KCM Mach RPC definition file used on OS X has the following copyright:

Copyright © 2009 Kungliga Tekniska Högskola

(Royal Institute of Technology, Stockholm, Sweden).

All rights reserved.

Portions Copyright © 2009 Apple Inc. All rights reserved.

Redistribution and use in source and binary forms, with or without modification, are permitted provided that the following conditions are met:

1. Redistributions of source code must retain the above copyright notice, this list of conditions and the following disclaimer.
2. Redistributions in binary form must reproduce the above copyright notice, this list of conditions and the following disclaimer in the documentation and/or other materials provided with the distribution.
3. Neither the name of the Institute nor the names of its contributors may be used to endorse or promote products derived from this software without specific prior written permission.

THIS SOFTWARE IS PROVIDED BY THE INSTITUTE AND CONTRIBUTORS "AS IS" AND ANY EXPRESS OR IMPLIED WARRANTIES, INCLUDING, BUT NOT LIMITED TO, THE IMPLIED WARRANTIES OF MERCHANTABILITY AND FITNESS FOR A PARTICULAR PURPOSE ARE DISCLAIMED. IN NO EVENT SHALL THE INSTITUTE OR CONTRIBUTORS BE LIABLE FOR ANY DIRECT, INDIRECT, INCIDENTAL, SPECIAL, EXEMPLARY, OR CONSEQUENTIAL DAMAGES (INCLUDING, BUT NOT LIMITED TO, PROCUREMENT OF SUBSTITUTE GOODS OR SERVICES; LOSS OF USE, DATA, OR PROFITS; OR BUSINESS INTERRUPTION) HOWEVER CAUSED AND ON ANY THEORY OF LIABILITY, WHETHER IN CONTRACT, STRICT LIABILITY, OR TORT (INCLUDING NEGLIGENCE OR OTHERWISE) ARISING IN ANY WAY OUT OF THE USE OF THIS SOFTWARE, EVEN IF ADVISED OF THE POSSIBILITY OF SUCH DAMAGE.

Portions of the RPC implementation in `src/lib/rpc` and `src/include/gssrpc` have the following copyright and permission notice:

Copyright © 2010, Oracle America, Inc.

All rights reserved.

Redistribution and use in source and binary forms, with or without modification, are permitted provided that the following conditions are met:

1. Redistributions of source code must retain the above copyright notice, this list of conditions and the following disclaimer.
2. Redistributions in binary form must reproduce the above copyright notice, this list of conditions and the following disclaimer in the documentation and/or other materials provided with the distribution.

3. Neither the name of the "Oracle America, Inc." nor the names of its contributors may be used to endorse or promote products derived from this software without specific prior written permission.

THIS SOFTWARE IS PROVIDED BY THE COPYRIGHT HOLDERS AND CONTRIBUTORS "AS IS" AND ANY EXPRESS OR IMPLIED WARRANTIES, INCLUDING, BUT NOT LIMITED TO, THE IMPLIED WARRANTIES OF MERCHANTABILITY AND FITNESS FOR A PARTICULAR PURPOSE ARE DISCLAIMED. IN NO EVENT SHALL THE COPYRIGHT HOLDER OR CONTRIBUTORS BE LIABLE FOR ANY DIRECT, INDIRECT, INCIDENTAL, SPECIAL, EXEMPLARY, OR CONSEQUENTIAL DAMAGES (INCLUDING, BUT NOT LIMITED TO, PROCUREMENT OF SUBSTITUTE GOODS OR SERVICES; LOSS OF USE, DATA, OR PROFITS; OR BUSINESS INTERRUPTION) HOWEVER CAUSED AND ON ANY THEORY OF LIABILITY, WHETHER IN CONTRACT, STRICT LIABILITY, OR TORT (INCLUDING NEGLIGENCE OR OTHERWISE) ARISING IN ANY WAY OUT OF THE USE OF THIS SOFTWARE, EVEN IF ADVISED OF THE POSSIBILITY OF SUCH DAMAGE.

Copyright © 2006,2007,2009 NTT (Nippon Telegraph and Telephone Corporation). All rights reserved.

Redistribution and use in source and binary forms, with or without modification, are permitted provided that the following conditions are met:

1. Redistributions of source code must retain the above copyright notice, this list of conditions and the following disclaimer as the first lines of this file unmodified.
2. Redistributions in binary form must reproduce the above copyright notice, this list of conditions and the following disclaimer in the documentation and/or other materials provided with the distribution.

THIS SOFTWARE IS PROVIDED BY NTT "AS IS" AND ANY EXPRESS OR IMPLIED WARRANTIES, INCLUDING, BUT NOT LIMITED TO, THE IMPLIED WARRANTIES OF MERCHANTABILITY AND FITNESS FOR A PARTICULAR PURPOSE ARE DISCLAIMED. IN NO EVENT SHALL NTT BE LIABLE FOR ANY DIRECT, INDIRECT, INCIDENTAL, SPECIAL, EXEMPLARY, OR CONSEQUENTIAL DAMAGES (INCLUDING, BUT NOT LIMITED TO, PROCUREMENT OF SUBSTITUTE GOODS OR SERVICES; LOSS OF USE, DATA, OR PROFITS; OR BUSINESS INTERRUPTION) HOWEVER CAUSED AND ON ANY THEORY OF LIABILITY, WHETHER IN CONTRACT, STRICT LIABILITY, OR TORT (INCLUDING NEGLIGENCE OR OTHERWISE) ARISING IN ANY WAY OUT OF THE USE OF THIS SOFTWARE, EVEN IF ADVISED OF THE POSSIBILITY OF SUCH DAMAGE.

Copyright 2000 by Carnegie Mellon University

All Rights Reserved

Permission to use, copy, modify, and distribute this software and its documentation for any purpose and without fee is hereby granted, provided that the above copyright notice appear in all copies and that both that copyright notice and this permission notice appear in supporting documentation, and that the name of Carnegie Mellon University not be used in advertising or publicity pertaining to distribution of the software without specific, written prior permission.

CARNEGIE MELLON UNIVERSITY DISCLAIMS ALL WARRANTIES WITH REGARD TO THIS SOFTWARE, INCLUDING ALL IMPLIED WARRANTIES OF MERCHANTABILITY AND FITNESS, IN NO EVENT SHALL CARNEGIE MELLON UNIVERSITY BE LIABLE FOR ANY SPECIAL, INDIRECT OR CONSEQUENTIAL DAMAGES OR ANY DAMAGES WHATSOEVER RESULTING FROM LOSS OF USE, DATA OR PROFITS, WHETHER IN AN ACTION OF CONTRACT, NEGLIGENCE OR OTHER TORTIOUS ACTION, ARISING OUT OF OR IN CONNECTION WITH THE USE OR PERFORMANCE OF THIS SOFTWARE.

Copyright © 2002 Naval Research Laboratory (NRL/CCS)

Permission to use, copy, modify and distribute this software and its documentation is hereby granted, provided that both the copyright notice and this permission notice appear in all copies of the software, derivative works or modified versions, and any portions thereof.

NRL ALLOWS FREE USE OF THIS SOFTWARE IN ITS "AS IS" CONDITION AND DISCLAIMS ANY LIABILITY OF ANY KIND FOR ANY DAMAGES WHATSOEVER RESULTING FROM THE USE OF THIS SOFTWARE.

Portions extracted from Internet RFCs have the following copyright notice:

Copyright (C) The Internet Society (2006).

This document is subject to the rights, licenses and restrictions contained in BCP 78, and except as set forth therein, the authors retain all their rights.

This document and the information contained herein are provided on an "AS IS" basis and THE CONTRIBUTOR, THE ORGANIZATION HE/SHE REPRESENTS OR IS SPONSORED BY (IF ANY), THE INTERNET SOCIETY AND THE INTERNET ENGINEERING TASK FORCE DISCLAIM ALL WARRANTIES, EXPRESS OR IMPLIED, INCLUDING BUT NOT LIMITED TO ANY WARRANTY THAT THE USE OF THE INFORMATION HEREIN WILL NOT INFRINGE ANY RIGHTS OR ANY IMPLIED WARRANTIES OF MERCHANTABILITY OR FITNESS FOR A PARTICULAR PURPOSE.

Copyright © 1991, 1992, 1994 by Cygnus Support.

Permission to use, copy, modify, and distribute this software and its documentation for any purpose and without fee is hereby granted, provided that the above copyright notice appear in all copies and that both that copyright notice and this permission notice appear in supporting documentation. Cygnus Support makes no representations about the suitability of this software for any purpose. It is provided "as is" without express or implied warranty.

Copyright © 2006 Secure Endpoints Inc.

Permission is hereby granted, free of charge, to any person obtaining a copy of this software and associated documentation files (the "Software"), to deal in the Software without restriction, including without limitation the rights to use, copy, modify, merge, publish, distribute, sublicense, and/or sell copies of the Software, and to permit persons to whom the Software is furnished to do so, subject to the following conditions:

The above copyright notice and this permission notice shall be included in all copies or substantial portions of the Software.

THE SOFTWARE IS PROVIDED "AS IS", WITHOUT WARRANTY OF ANY KIND, EXPRESS OR IMPLIED, INCLUDING BUT NOT LIMITED TO THE WARRANTIES OF MERCHANTABILITY, FITNESS FOR A PARTICULAR PURPOSE AND NONINFRINGEMENT. IN NO EVENT SHALL THE AUTHORS OR COPYRIGHT HOLDERS BE LIABLE FOR ANY CLAIM, DAMAGES OR OTHER LIABILITY, WHETHER IN AN ACTION OF CONTRACT, TORT OR OTHERWISE, ARISING FROM, OUT OF OR IN CONNECTION WITH THE SOFTWARE OR THE USE OR OTHER DEALINGS IN THE SOFTWARE.

Portions of the implementation of the Fortuna-like PRNG are subject to the following notice:

Copyright © 2005 Marko Kreen

All rights reserved.

Redistribution and use in source and binary forms, with or without modification, are permitted provided that the following conditions are met:

1. Redistributions of source code must retain the above copyright notice, this list of conditions and the following disclaimer.
2. Redistributions in binary form must reproduce the above copyright notice, this list of conditions and the following disclaimer in the documentation and/or other materials provided with the distribution.

THIS SOFTWARE IS PROVIDED BY THE AUTHOR AND CONTRIBUTORS "AS IS" AND ANY EXPRESS OR IMPLIED WARRANTIES, INCLUDING, BUT NOT LIMITED TO, THE IMPLIED WARRANTIES OF MERCHANTABILITY AND FITNESS FOR A PARTICULAR PURPOSE ARE DISCLAIMED. IN NO EVENT SHALL THE AUTHOR OR CONTRIBUTORS BE LIABLE FOR ANY DIRECT, INDIRECT, INCIDENTAL, SPECIAL, EXEMPLARY, OR CONSEQUENTIAL DAMAGES (INCLUDING, BUT NOT LIMITED TO, PROCUREMENT OF SUBSTITUTE GOODS OR SERVICES; LOSS OF USE, DATA, OR PROFITS; OR BUSINESS INTERRUPTION) HOWEVER CAUSED AND ON ANY THEORY OF LIABILITY, WHETHER IN CONTRACT, STRICT LIABILITY, OR TORT (INCLUDING NEGLIGENCE OR OTHERWISE) ARISING IN ANY WAY OUT OF THE USE OF THIS SOFTWARE, EVEN IF ADVISED OF THE POSSIBILITY OF SUCH DAMAGE.

Copyright © 1994 by the University of Southern California

EXPORT OF THIS SOFTWARE from the United States of America may require a specific license from the United States Government. It is the responsibility of any person or organization contemplating export to obtain such a license before exporting.

WITHIN THAT CONSTRAINT, permission to copy, modify, and distribute this software and its documentation in source and binary forms is hereby granted, provided that any documentation or other materials related to such distribution or use acknowledge that the software was developed by the University of Southern California.

DISCLAIMER OF WARRANTY. THIS SOFTWARE IS PROVIDED "AS IS". The University of Southern California MAKES NO REPRESENTATIONS OR WARRANTIES, EXPRESS OR IMPLIED. By way of example, but not limitation, the University of Southern California MAKES NO REPRESENTATIONS OR WARRANTIES OF MERCHANTABILITY OR FITNESS FOR ANY PARTICULAR PURPOSE. The University of Southern California shall not be held liable for any liability nor for any direct, indirect, or consequential damages with respect to any claim by the user or distributor of the ksu software.

Copyright © 1995

The President and Fellows of Harvard University

This code is derived from software contributed to Harvard by Jeremy Rassen.

Redistribution and use in source and binary forms, with or without modification, are permitted provided that the following conditions are met:

1. Redistributions of source code must retain the above copyright notice, this list of conditions and the following disclaimer.

2. Redistributions in binary form must reproduce the above copyright notice, this list of conditions and the following disclaimer in the documentation and/or other materials provided with the distribution.
3. All advertising materials mentioning features or use of this software must display the following acknowledgement:

This product includes software developed by the University of California, Berkeley and its contributors.
4. Neither the name of the University nor the names of its contributors may be used to endorse or promote products derived from this software without specific prior written permission.

THIS SOFTWARE IS PROVIDED BY THE REGENTS AND CONTRIBUTORS "AS IS" AND ANY EXPRESS OR IMPLIED WARRANTIES, INCLUDING, BUT NOT LIMITED TO, THE IMPLIED WARRANTIES OF MERCHANTABILITY AND FITNESS FOR A PARTICULAR PURPOSE ARE DISCLAIMED. IN NO EVENT SHALL THE REGENTS OR CONTRIBUTORS BE LIABLE FOR ANY DIRECT, INDIRECT, INCIDENTAL, SPECIAL, EXEMPLARY, OR CONSEQUENTIAL DAMAGES (INCLUDING, BUT NOT LIMITED TO, PROCUREMENT OF SUBSTITUTE GOODS OR SERVICES; LOSS OF USE, DATA, OR PROFITS; OR BUSINESS INTERRUPTION) HOWEVER CAUSED AND ON ANY THEORY OF LIABILITY, WHETHER IN CONTRACT, STRICT LIABILITY, OR TORT (INCLUDING NEGLIGENCE OR OTHERWISE) ARISING IN ANY WAY OUT OF THE USE OF THIS SOFTWARE, EVEN IF ADVISED OF THE POSSIBILITY OF SUCH DAMAGE.

Copyright © 2008 by the Massachusetts Institute of Technology.

Copyright 1995 by Richard P. Basch. All Rights Reserved.

Copyright 1995 by Lehman Brothers, Inc. All Rights Reserved.

Export of this software from the United States of America may require a specific license from the United States Government. It is the responsibility of any person or organization contemplating export to obtain such a license before exporting.

WITHIN THAT CONSTRAINT, permission to use, copy, modify, and distribute this software and its documentation for any purpose and without fee is hereby granted, provided that the above copyright notice appear in all copies and that both that copyright notice and this permission notice appear in supporting documentation, and that the name of Richard P. Basch, Lehman Brothers and M.I.T. not be used in advertising or publicity pertaining to distribution of the software without specific, written prior permission. Richard P. Basch, Lehman Brothers and M.I.T. make no representations about the suitability of this software for any purpose. It is provided "as is" without express or implied warranty.

The following notice applies to `src/lib/krb5/krb/strptime.c` and `src/include/k5-queue.h`.

Copyright © 1997, 1998 The NetBSD Foundation, Inc.

All rights reserved.

This code was contributed to The NetBSD Foundation by Klaus Klein.

Redistribution and use in source and binary forms, with or without modification, are permitted provided that the following conditions are met:

1. Redistributions of source code must retain the above copyright notice, this list of conditions and the following disclaimer.
2. Redistributions in binary form must reproduce the above copyright notice, this list of conditions and the following disclaimer in the documentation and/or other materials provided with the distribution.
3. All advertising materials mentioning features or use of this software must display the following acknowledgement:

This product includes software developed by the NetBSD Foundation, Inc. and its contributors.

4. Neither the name of The NetBSD Foundation nor the names of its contributors may be used to endorse or promote products derived from this software without specific prior written permission.

THIS SOFTWARE IS PROVIDED BY THE NETBSD FOUNDATION, INC. AND CONTRIBUTORS "AS IS" AND ANY EXPRESS OR IMPLIED WARRANTIES, INCLUDING, BUT NOT LIMITED TO, THE IMPLIED WARRANTIES OF MERCHANTABILITY AND FITNESS FOR A PARTICULAR PURPOSE ARE DISCLAIMED. IN NO EVENT SHALL THE FOUNDATION OR CONTRIBUTORS BE LIABLE FOR ANY DIRECT, INDIRECT, INCIDENTAL, SPECIAL, EXEMPLARY, OR CONSEQUENTIAL DAMAGES (INCLUDING, BUT NOT LIMITED TO, PROCUREMENT OF SUBSTITUTE GOODS OR SERVICES; LOSS OF USE, DATA, OR PROFITS; OR BUSINESS INTERRUPTION) HOWEVER CAUSED AND ON ANY THEORY OF LIABILITY, WHETHER IN CONTRACT, STRICT LIABILITY, OR TORT (INCLUDING NEGLIGENCE OR OTHERWISE) ARISING IN ANY WAY OUT OF THE USE OF THIS SOFTWARE, EVEN IF ADVISED OF THE POSSIBILITY OF SUCH DAMAGE.

The following notice applies to Unicode library files in `src/lib/krb5/unicode`:

Copyright 1997, 1998, 1999 Computing Research Labs,

New Mexico State University

Permission is hereby granted, free of charge, to any person obtaining a copy of this software and associated documentation files (the "Software"), to deal in the Software without restriction, including without limitation the rights to use, copy, modify, merge, publish, distribute, sublicense, and/or sell copies of the Software, and to permit persons to whom the Software is furnished to do so, subject to the following conditions:

The above copyright notice and this permission notice shall be included in all copies or substantial portions of the Software.

THE SOFTWARE IS PROVIDED "AS IS", WITHOUT WARRANTY OF ANY KIND, EXPRESS OR IMPLIED, INCLUDING BUT NOT LIMITED TO THE WARRANTIES OF MERCHANTABILITY, FITNESS FOR A PARTICULAR PURPOSE AND NONINFRINGEMENT. IN NO EVENT SHALL THE COMPUTING RESEARCH LAB OR NEW MEXICO STATE UNIVERSITY BE LIABLE FOR ANY CLAIM, DAMAGES OR OTHER LIABILITY, WHETHER IN AN ACTION OF CONTRACT, TORT OR OTHERWISE, ARISING FROM, OUT OF OR IN CONNECTION WITH THE SOFTWARE OR THE USE OR OTHER DEALINGS IN THE SOFTWARE.

The following notice applies to `src/util/support/strncpy.c`:

Copyright © 1998 Todd C. Miller Todd.Miller@courtesan.com

Permission to use, copy, modify, and distribute this software for any purpose with or without fee is hereby granted, provided that the above copyright notice and this permission notice appear in all copies.

THE SOFTWARE IS PROVIDED "AS IS" AND THE AUTHOR DISCLAIMS ALL WARRANTIES WITH REGARD TO THIS SOFTWARE INCLUDING ALL IMPLIED WARRANTIES OF MERCHANTABILITY AND FITNESS. IN NO EVENT SHALL THE AUTHOR BE LIABLE FOR ANY SPECIAL, DIRECT, INDIRECT, OR CONSEQUENTIAL DAMAGES OR ANY DAMAGES WHATSOEVER RESULTING FROM LOSS OF USE, DATA OR PROFITS, WHETHER IN AN ACTION OF CONTRACT, NEGLIGENCE OR OTHER TORTIOUS ACTION, ARISING OUT OF OR IN CONNECTION WITH THE USE OR PERFORMANCE OF THIS SOFTWARE.

The following notice applies to `src/util/profile/argv_parse.c` and `src/util/profile/argv_parse.h`:

Copyright 1999 by Theodore Ts'o.

Permission to use, copy, modify, and distribute this software for any purpose with or without fee is hereby granted, provided that the above copyright notice and this permission notice appear in all copies. THE SOFTWARE IS PROVIDED "AS IS" AND THEODORE TS'O (THE AUTHOR) DISCLAIMS ALL WARRANTIES WITH REGARD TO THIS SOFTWARE, INCLUDING ALL IMPLIED WARRANTIES OF MERCHANTABILITY AND FITNESS. IN NO EVENT SHALL THE AUTHOR BE LIABLE FOR ANY SPECIAL, DIRECT, INDIRECT, OR CONSEQUENTIAL DAMAGES OR ANY DAMAGES WHATSOEVER RESULTING FROM LOSS OF USE, DATA OR PROFITS, WHETHER IN AN ACTION OF CONTRACT, NEGLIGENCE OR OTHER TORTIOUS ACTION, ARISING OUT OF OR IN CONNECTION WITH THE USE OR PERFORMANCE OF THIS SOFTWARE. (Isn't it sick that the U.S. culture of lawsuit-happy lawyers requires this kind of disclaimer?)

The following notice applies to SWIG-generated code in `src/util/profile/profile_tcl.c`:

Copyright © 1999-2000, The University of Chicago

This file may be freely redistributed without license or fee provided this copyright message remains intact.

The following notice applies to portions of `src/lib/rpc` and `src/include/gssrpc`:

Copyright © 2000 The Regents of the University of Michigan. All rights reserved.

Copyright © 2000 Dug Song dugsong@UMICH.EDU. All rights reserved, all wrongs reversed.

Redistribution and use in source and binary forms, with or without modification, are permitted provided that the following conditions are met:

1. Redistributions of source code must retain the above copyright notice, this list of conditions and the following disclaimer.
2. Redistributions in binary form must reproduce the above copyright notice, this list of conditions and the following disclaimer in the documentation and/or other materials provided with the distribution.
3. Neither the name of the University nor the names of its contributors may be used to endorse or promote products derived from this software without specific prior written permission.

THIS SOFTWARE IS PROVIDED "AS IS" AND ANY EXPRESS OR IMPLIED WARRANTIES, INCLUDING, BUT NOT LIMITED TO, THE IMPLIED WARRANTIES OF MERCHANTABILITY AND FITNESS FOR A PARTICULAR PURPOSE ARE DISCLAIMED. IN NO EVENT SHALL THE REGENTS OR CONTRIBUTORS BE LIABLE FOR ANY DIRECT, INDIRECT, INCIDENTAL, SPECIAL, EXEMPLARY, OR CONSEQUENTIAL DAMAGES (INCLUDING, BUT NOT LIMITED TO, PROCUREMENT OF SUBSTITUTE GOODS OR SERVICES; LOSS OF USE, DATA, OR PROFITS; OR BUSINESS INTERRUPTION) HOWEVER CAUSED AND ON ANY THEORY OF LIABILITY, WHETHER IN CONTRACT, STRICT LIABILITY, OR TORT (INCLUDING NEGLIGENCE OR OTHERWISE) ARISING IN ANY WAY OUT OF THE USE OF THIS SOFTWARE, EVEN IF ADVISED OF THE POSSIBILITY OF SUCH DAMAGE.

Implementations of the MD4 algorithm are subject to the following notice:

Copyright © 1990, RSA Data Security, Inc. All rights reserved.

License to copy and use this software is granted provided that it is identified as the "RSA Data Security, Inc. MD4 Message Digest Algorithm" in all material mentioning or referencing this software or this function.

License is also granted to make and use derivative works provided that such works are identified as "derived from the RSA Data Security, Inc. MD4 Message Digest Algorithm" in all material mentioning or referencing the derived work.

RSA Data Security, Inc. makes no representations concerning either the merchantability of this software or the suitability of this software for any particular purpose. It is provided "as is" without express or implied warranty of any kind.

These notices must be retained in any copies of any part of this documentation and/or software.

Implementations of the MD5 algorithm are subject to the following notice:

Copyright © 1990, RSA Data Security, Inc. All rights reserved.

License to copy and use this software is granted provided that it is identified as the "RSA Data Security, Inc. MD5 Message- Digest Algorithm" in all material mentioning or referencing this software or this function.

License is also granted to make and use derivative works provided that such works are identified as "derived from the RSA Data Security, Inc. MD5 Message-Digest Algorithm" in all material mentioning or referencing the derived work.

RSA Data Security, Inc. makes no representations concerning either the merchantability of this software or the suitability of this software for any particular purpose. It is provided "as is" without express or implied warranty of any kind.

These notices must be retained in any copies of any part of this documentation and/or software.

The following notice applies to `src/lib/crypto/crypto_tests/t_mddriver.c`:

Copyright © 1990-2, RSA Data Security, Inc. Created 1990. All rights reserved.

RSA Data Security, Inc. makes no representations concerning either the merchantability of this software or the suitability of this software for any particular purpose. It is provided "as is" without express or implied warranty of any kind.

These notices must be retained in any copies of any part of this documentation and/or software.

Portions of `src/lib/krb5` are subject to the following notice:

Copyright © 1994 CyberSAFE Corporation.

Copyright 1990,1991,2007,2008 by the Massachusetts Institute of Technology.

All Rights Reserved.

Export of this software from the United States of America may require a specific license from the United States Government. It is the responsibility of any person or organization contemplating export to obtain such a license before exporting.

WITHIN THAT CONSTRAINT, permission to use, copy, modify, and distribute this software and its documentation for any purpose and without fee is hereby granted, provided that the above copyright notice appear in all copies and that both that copyright notice and this permission notice appear in supporting documentation, and that the name of M.I.T. not be used in advertising or publicity pertaining to distribution of the software without specific, written prior permission. Furthermore if you modify this software you must label your software as modified software and not distribute it in such a fashion that it might be confused with the original M.I.T. software. Neither M.I.T., the Open Computing Security Group, nor CyberSAFE Corporation make any representations about the suitability of this software for any purpose. It is provided "as is" without express or implied warranty.

Portions contributed by PADL Software are subject to the following license:

Copyright (c) 2011, PADL Software Pty Ltd. All rights reserved.

Redistribution and use in source and binary forms, with or without modification, are permitted provided that the following conditions are met:

1. Redistributions of source code must retain the above copyright notice, this list of conditions and the following disclaimer.
2. Redistributions in binary form must reproduce the above copyright notice, this list of conditions and the following disclaimer in the documentation and/or other materials provided with the distribution.
3. Neither the name of PADL Software nor the names of its contributors may be used to endorse or promote products derived from this software without specific prior written permission.

THIS SOFTWARE IS PROVIDED BY PADL SOFTWARE AND CONTRIBUTORS "AS IS" AND ANY EXPRESS OR IMPLIED WARRANTIES, INCLUDING, BUT NOT LIMITED TO, THE IMPLIED WARRANTIES OF MERCHANTABILITY AND FITNESS FOR A PARTICULAR PURPOSE ARE DISCLAIMED. IN NO EVENT SHALL PADL SOFTWARE OR CONTRIBUTORS BE LIABLE FOR ANY DIRECT, INDIRECT, INCIDENTAL, SPECIAL, EXEMPLARY, OR CONSEQUENTIAL DAMAGES (INCLUDING, BUT NOT LIMITED TO, PROCUREMENT OF SUBSTITUTE GOODS OR SERVICES; LOSS OF USE, DATA, OR PROFITS; OR BUSINESS INTERRUPTION) HOWEVER CAUSED AND ON ANY THEORY OF LIABILITY, WHETHER IN CONTRACT, STRICT LIABILITY, OR TORT (INCLUDING NEGLIGENCE OR OTHERWISE) ARISING IN ANY WAY OUT OF THE USE OF THIS SOFTWARE, EVEN IF ADVISED OF THE POSSIBILITY OF SUCH DAMAGE.

The bundled libev source code is subject to the following license:

All files in libev are Copyright (C)2007,2008,2009 Marc Alexander Lehmann.

Redistribution and use in source and binary forms, with or without modification, are permitted provided that the following conditions are met:

- Redistributions of source code must retain the above copyright notice, this list of conditions and the following disclaimer.
- Redistributions in binary form must reproduce the above copyright notice, this list of conditions and the following disclaimer in the documentation and/or other materials provided with the distribution.

THIS SOFTWARE IS PROVIDED BY THE COPYRIGHT HOLDERS AND CONTRIBUTORS "AS IS" AND ANY EXPRESS OR IMPLIED WARRANTIES, INCLUDING, BUT NOT LIMITED TO, THE IMPLIED WARRANTIES OF MERCHANTABILITY AND FITNESS FOR A PARTICULAR PURPOSE ARE DISCLAIMED. IN NO EVENT SHALL THE COPYRIGHT OWNER OR CONTRIBUTORS BE LIABLE FOR ANY DIRECT, INDIRECT, INCIDENTAL, SPECIAL, EXEMPLARY, OR CONSEQUENTIAL DAMAGES (INCLUDING, BUT NOT LIMITED TO, PROCUREMENT OF SUBSTITUTE GOODS OR SERVICES; LOSS OF USE, DATA, OR PROFITS; OR BUSINESS INTERRUPTION) HOWEVER CAUSED AND ON ANY THEORY OF LIABILITY, WHETHER IN CONTRACT, STRICT LIABILITY, OR TORT (INCLUDING NEGLIGENCE OR OTHERWISE) ARISING IN ANY WAY OUT OF THE USE OF THIS SOFTWARE, EVEN IF ADVISED OF THE POSSIBILITY OF SUCH DAMAGE.

Alternatively, the contents of this package may be used under the terms of the GNU General Public License ("GPL") version 2 or any later version, in which case the provisions of the GPL are applicable instead of the above. If you wish to allow the use of your version of this package only under the terms of the GPL and not to allow others to use your version of this file under the BSD license, indicate your decision by deleting the provisions above and replace them with the notice and other provisions required by the GPL in this and the other files of this package. If you do not delete the provisions above, a recipient may use your version of this file under either the BSD or the GPL.

Files copied from the Intel AESNI Sample Library are subject to the following license:

Copyright © 2010, Intel Corporation.

All rights reserved.

Redistribution and use in source and binary forms, with or without modification, are permitted provided that the following conditions are met:

- Redistributions of source code must retain the above copyright notice, this list of conditions and the following disclaimer.
- Redistributions in binary form must reproduce the above copyright notice, this list of conditions and the following disclaimer in the documentation and/or other materials provided with the distribution.
- Neither the name of Intel Corporation nor the names of its contributors may be used to endorse or promote products derived from this software without specific prior written permission.

THIS SOFTWARE IS PROVIDED BY THE COPYRIGHT HOLDERS AND CONTRIBUTORS "AS IS" AND ANY EXPRESS OR IMPLIED WARRANTIES, INCLUDING, BUT NOT LIMITED TO, THE IMPLIED WARRANTIES OF MERCHANTABILITY AND FITNESS FOR A PARTICULAR PURPOSE ARE DISCLAIMED. IN NO EVENT SHALL THE COPYRIGHT OWNER OR CONTRIBUTORS BE LIABLE FOR ANY DIRECT, INDIRECT, INCIDENTAL, SPECIAL, EXEMPLARY, OR CONSEQUENTIAL DAMAGES (INCLUDING, BUT NOT LIMITED TO, PROCUREMENT OF SUBSTITUTE GOODS OR SERVICES; LOSS OF USE, DATA, OR PROFITS; OR BUSINESS INTERRUPTION) HOWEVER CAUSED AND ON ANY THEORY OF LIABILITY, WHETHER IN CONTRACT, STRICT LIABILITY, OR TORT (INCLUDING NEGLIGENCE OR OTHERWISE) ARISING IN ANY WAY OUT OF THE USE OF THIS SOFTWARE, EVEN IF ADVISED OF THE POSSIBILITY OF SUCH DAMAGE.

The following notice applies to "src/ccapi/common/win/OldCC/autolock.hxx":

Copyright (C) 1998 by Danilo Almeida. All rights reserved.

Redistribution and use in source and binary forms, with or without modification, are permitted provided that the following conditions are met:

- Redistributions of source code must retain the above copyright notice, this list of conditions and the following disclaimer.
- Redistributions in binary form must reproduce the above copyright notice, this list of conditions and the following disclaimer in the documentation and/or other materials provided with the distribution.

THIS SOFTWARE IS PROVIDED BY THE COPYRIGHT HOLDERS AND CONTRIBUTORS "AS IS" AND ANY EXPRESS OR IMPLIED WARRANTIES, INCLUDING, BUT NOT LIMITED TO, THE IMPLIED WARRANTIES OF MERCHANTABILITY AND FITNESS FOR A PARTICULAR PURPOSE ARE DISCLAIMED. IN NO EVENT SHALL THE COPYRIGHT HOLDER OR CONTRIBUTORS BE LIABLE FOR ANY DIRECT, INDIRECT, INCIDENTAL, SPECIAL, EXEMPLARY, OR CONSEQUENTIAL DAMAGES (INCLUDING, BUT NOT LIMITED TO, PROCUREMENT OF SUBSTITUTE GOODS OR SERVICES; LOSS OF USE, DATA, OR PROFITS; OR BUSINESS INTERRUPTION) HOWEVER CAUSED AND ON ANY THEORY OF LIABILITY, WHETHER IN CONTRACT, STRICT LIABILITY, OR TORT (INCLUDING NEGLIGENCE OR OTHERWISE) ARISING IN ANY WAY OUT OF THE USE OF THIS SOFTWARE, EVEN IF ADVISED OF THE POSSIBILITY OF SUCH DAMAGE.

The following notice applies to portions of

"src/plugins/preauth/spake/edwards25519.c" and

"src/plugins/preauth/spake/edwards25519_tables.h":

The MIT License (MIT)

Copyright (c) 2015-2016 the fiat-crypto authors (see the AUTHORS file).

Permission is hereby granted, free of charge, to any person obtaining a copy of this software and associated documentation files (the "Software"), to deal in the Software without restriction, including without limitation the rights to use, copy, modify, merge, publish, distribute, sublicense, and/or sell copies of the Software, and to permit persons to whom the Software is furnished to do so, subject to the following conditions:

The above copyright notice and this permission notice shall be included in all copies or substantial portions of the Software.

THE SOFTWARE IS PROVIDED "AS IS", WITHOUT WARRANTY OF ANY KIND, EXPRESS OR IMPLIED, INCLUDING BUT NOT LIMITED TO THE WARRANTIES OF MERCHANTABILITY, FITNESS FOR A PARTICULAR PURPOSE AND NONINFRINGEMENT. IN NO EVENT SHALL THE AUTHORS OR COPYRIGHT HOLDERS BE LIABLE FOR ANY CLAIM, DAMAGES OR OTHER LIABILITY, WHETHER IN AN ACTION OF CONTRACT, TORT OR OTHERWISE, ARISING FROM, OUT OF OR IN CONNECTION WITH THE SOFTWARE OR THE USE OR OTHER DEALINGS IN THE SOFTWARE.

The following notice applies to portions of

"src/plugins/preauth/spake/edwards25519.c":

Copyright (c) 2015-2016, Google Inc.

Permission to use, copy, modify, and/or distribute this software for any purpose with or without fee is hereby granted, provided that the above copyright notice and this permission notice appear in all copies.

THE SOFTWARE IS PROVIDED "AS IS" AND THE AUTHOR DISCLAIMS ALL WARRANTIES WITH REGARD TO THIS SOFTWARE INCLUDING ALL IMPLIED WARRANTIES OF MERCHANTABILITY AND FITNESS. IN NO EVENT SHALL THE AUTHOR BE LIABLE FOR ANY SPECIAL, DIRECT, INDIRECT, OR CONSEQUENTIAL DAMAGES OR ANY DAMAGES WHATSOEVER RESULTING FROM LOSS OF USE, DATA OR PROFITS, WHETHER IN AN ACTION OF CONTRACT, NEGLIGENCE OR OTHER TORTIOUS ACTION, ARISING OUT OF OR IN CONNECTION WITH THE USE OR PERFORMANCE OF THIS SOFTWARE.

License for Libedit

Pulse Secure Virtual Traffic Manager contains code from Libedit – a command line editor library. The following copyright notice applies:

Version: 0.3

License summary: BSD 3-clause "New" or "Revised" License

Copyright notice:

Copyright (c) 1997 The NetBSD Foundation, Inc. All rights reserved.

This code is derived from software contributed to The NetBSD Foundation by Jaromir Dolecek.

Redistribution and use in source and binary forms, with or without modification, are permitted provided that the following conditions are met:

1. Redistributions of source code must retain the above copyright notice, this list of conditions and the following disclaimer.
2. Redistributions in binary form must reproduce the above copyright notice, this list of conditions and the following disclaimer in the documentation and/or other materials provided with the distribution.
3. All advertising materials mentioning features or use of this software must display the following acknowledgement:

This product includes software developed by the NetBSD Foundation, Inc. and its contributors.

4. Neither the name of The NetBSD Foundation nor the names of its contributors may be used to endorse or promote products derived from this software without specific prior written permission.

THIS SOFTWARE IS PROVIDED BY THE NETBSD FOUNDATION, INC. AND CONTRIBUTORS "AS IS" AND ANY EXPRESS OR IMPLIED WARRANTIES, INCLUDING, BUT NOT LIMITED TO, THE IMPLIED WARRANTIES OF MERCHANTABILITY AND FITNESS FOR A PARTICULAR PURPOSE ARE DISCLAIMED. IN NO EVENT SHALL THE FOUNDATION OR CONTRIBUTORS BE LIABLE FOR ANY DIRECT, INDIRECT, INCIDENTAL, SPECIAL, EXEMPLARY, OR CONSEQUENTIAL DAMAGES (INCLUDING, BUT NOT LIMITED TO, PROCUREMENT OF SUBSTITUTE GOODS OR SERVICES; LOSS OF USE, DATA, OR PROFITS; OR BUSINESS INTERRUPTION) HOWEVER CAUSED AND ON ANY THEORY OF LIABILITY, WHETHER IN CONTRACT, STRICT LIABILITY, OR TORT (INCLUDING NEGLIGENCE OR OTHERWISE) ARISING IN ANY WAY OUT OF THE USE OF THIS SOFTWARE, EVEN IF ADVISED OF THE POSSIBILITY OF SUCH DAMAGE.

Copyright (c) 1992, 1993 The Regents of the University of California. All rights reserved.

This code is derived from software contributed to Berkeley by Christos Zoulas of Cornell University.

Redistribution and use in source and binary forms, with or without modification, are permitted provided that the following conditions are met:

1. Redistributions of source code must retain the above copyright notice, this list of conditions and the following disclaimer.
2. Redistributions in binary form must reproduce the above copyright notice, this list of conditions and the following disclaimer in the documentation and/or other materials provided with the distribution.
3. All advertising materials mentioning features or use of this software must display the following acknowledgement:

This product includes software developed by the University of California, Berkeley and its contributors.

4. Neither the name of the University nor the names of its contributors may be used to endorse or promote products derived from this software without specific prior written permission.

THIS SOFTWARE IS PROVIDED BY THE REGENTS AND CONTRIBUTORS "AS IS" AND ANY EXPRESS OR IMPLIED WARRANTIES, INCLUDING, BUT NOT LIMITED TO, THE IMPLIED WARRANTIES OF MERCHANTABILITY AND FITNESS FOR A PARTICULAR PURPOSE ARE DISCLAIMED. IN NO EVENT SHALL THE REGENTS OR CONTRIBUTORS BE LIABLE FOR ANY DIRECT, INDIRECT, INCIDENTAL, SPECIAL, EXEMPLARY, OR CONSEQUENTIAL DAMAGES (INCLUDING, BUT NOT LIMITED TO, PROCUREMENT OF SUBSTITUTE GOODS OR SERVICES; LOSS OF USE, DATA, OR PROFITS; OR BUSINESS INTERRUPTION) HOWEVER CAUSED AND ON ANY THEORY OF LIABILITY, WHETHER IN CONTRACT, STRICT LIABILITY, OR TORT (INCLUDING NEGLIGENCE OR OTHERWISE) ARISING IN ANY WAY OUT OF THE USE OF THIS SOFTWARE, EVEN IF ADVISED OF THE POSSIBILITY OF SUCH DAMAGE.

License for ZebOS

Pulse Secure Virtual Traffic Manager contains code from the ZebOS routing suite, distributed under license from IP Infusion, Inc. The ZebOS routing suite is Copyright (C) 2001-2014 IP Infusion, Inc. All Rights Reserved.

License for Curl

Pulse Secure Virtual Traffic Manager contains code from Curl – a command line tool and library for transferring data. The following copyright notice applies:

Version: 7.58.0

License summary: MIT

Copyright notice:

COPYRIGHT AND PERMISSION NOTICE

Copyright (c) 1996 - 2018, Daniel Stenberg, <daniel@haxx.se>, and many contributors, see the THANKS file.

All rights reserved.

Permission to use, copy, modify, and distribute this software for any purpose with or without fee is hereby granted, provided that the above copyright notice and this permission notice appear in all copies.

THE SOFTWARE IS PROVIDED "AS IS", WITHOUT WARRANTY OF ANY KIND, EXPRESS OR IMPLIED, INCLUDING BUT NOT LIMITED TO THE WARRANTIES OF MERCHANTABILITY, FITNESS FOR A PARTICULAR PURPOSE AND NONINFRINGEMENT OF THIRD PARTY RIGHTS. IN NO EVENT SHALL THE AUTHORS OR COPYRIGHT HOLDERS BE LIABLE FOR ANY CLAIM, DAMAGES OR OTHER LIABILITY, WHETHER IN AN ACTION OF CONTRACT, TORT OR OTHERWISE, ARISING FROM, OUT OF OR IN CONNECTION WITH THE SOFTWARE OR THE USE OR OTHER DEALINGS IN THE SOFTWARE.

Except as contained in this notice, the name of a copyright holder shall not be used in advertising or otherwise to promote the sale, use or other dealings in this Software without prior written authorization of the copyright holder.

License for Jansson

Pulse Secure Virtual Traffic Manager contains code from Jansson – a JSON support library. The following copyright notice applies:

Version: 2.7

License summary: MIT

Copyright notice:

Copyright (c) 2009-2014 Petri Lehtinen <petri@digip.org>

Permission is hereby granted, free of charge, to any person obtaining a copy of this software and associated documentation files (the "Software"), to deal in the Software without restriction, including without limitation the rights to use, copy, modify, merge, publish, distribute, sublicense, and/or sell copies of the Software, and to permit persons to whom the Software is furnished to do so, subject to the following conditions:

The above copyright notice and this permission notice shall be included in all copies or substantial portions of the Software.

THE SOFTWARE IS PROVIDED "AS IS", WITHOUT WARRANTY OF ANY KIND, EXPRESS OR IMPLIED, INCLUDING BUT NOT LIMITED TO THE WARRANTIES OF MERCHANTABILITY, FITNESS FOR A PARTICULAR PURPOSE AND NONINFRINGEMENT. IN NO EVENT SHALL THE AUTHORS OR COPYRIGHT HOLDERS BE LIABLE FOR ANY CLAIM, DAMAGES OR OTHER LIABILITY, WHETHER IN AN ACTION OF CONTRACT, TORT OR OTHERWISE, ARISING FROM, OUT OF OR IN CONNECTION WITH THE SOFTWARE OR THE USE OR OTHER DEALINGS IN THE SOFTWARE.

License for Digest::SHA

Pulse Secure Virtual Traffic Manager contains code from Digest::SHA – a Perl library used to calculate SHA message digests. The following copyright notice applies:

Version: 5.95

License summary: Perl Artistic License

Copyright notice:

Copyright (C) 2003-2015 Mark Shelor

This library is free software; you can redistribute it and/or modify it under the same terms as Perl itself. See the Perl Artistic License for details: <http://search.cpan.org/perldoc?perlartistic>

License for Sys::SysLog

Pulse Secure Virtual Traffic Manager contains code from Sys::SysLog – a Perl library used as an interface to the UNIX syslog program. The following copyright notice applies:

Version: 0.27

License summary: Perl Artistic License

Copyright notice:

Copyright (C) 1990-2012 by Larry Wall and others.

This library is free software; you can redistribute it and/or modify it under the same terms as Perl itself. See the Perl Artistic License for details: <http://search.cpan.org/perldoc?perlartistic>

License for libpcap

Pulse Secure Virtual Traffic Manager contains code from libpcap – a library used to support packet capture. The following copyright notice applies:

Version: 1.8.1

License summary: BSD

Copyright notice:

Redistribution and use in source and binary forms, with or without modification, are permitted provided that the following conditions are met:

1. Redistributions of source code must retain the above copyright notice, this list of conditions and the following disclaimer.
2. Redistributions in binary form must reproduce the above copyright notice, this list of conditions and the following disclaimer in the documentation and/or other materials provided with the distribution.
3. The names of the authors may not be used to endorse or promote products derived from this software without specific prior written permission.

THIS SOFTWARE IS PROVIDED ``AS IS" AND WITHOUT ANY EXPRESS OR IMPLIED WARRANTIES, INCLUDING, WITHOUT LIMITATION, THE IMPLIED WARRANTIES OF MERCHANTABILITY AND FITNESS FOR A PARTICULAR PURPOSE.

License for elfutils

Pulse Secure Virtual Traffic Manager contains code from elfutils – a set of utilities and libraries for handling ELF (Executable and Linkable Format) files. The following copyright notice applies:

Version: 0.175

License summary: GPLv2

Copyright notice:

GNU GENERAL PUBLIC LICENSE

Version 2, June 1991

Copyright (C) 1989, 1991 Free Software Foundation, Inc., 51 Franklin Street, Fifth Floor, Boston, MA 02110-1301 USA

Everyone is permitted to copy and distribute verbatim copies of this license document, but changing it is not allowed.

Preamble

The licenses for most software are designed to take away your freedom to share and change it. By contrast, the GNU General Public License is intended to guarantee your freedom to share and change free software--to make sure the software is free for all its users. This General Public License applies to most of the Free Software Foundation's software and to any other program whose authors commit to using it. (Some other Free Software Foundation software is covered by the GNU Lesser General Public License instead.) You can apply it to your programs, too.

When we speak of free software, we are referring to freedom, not price. Our General Public Licenses are designed to make sure that you have the freedom to distribute copies of free software (and charge for this service if you wish), that you receive source code or can get it if you want it, that you can change the software or use pieces of it in new free programs; and that you know you can do these things.

To protect your rights, we need to make restrictions that forbid anyone to deny you these rights or to ask you to surrender the rights. These restrictions translate to certain responsibilities for you if you distribute copies of the software, or if you modify it.

For example, if you distribute copies of such a program, whether gratis or for a fee, you must give the recipients all the rights that you have. You must make sure that they, too, receive or can get the source code. And you must show them these terms so they know their rights.

We protect your rights with two steps: (1) copyright the software, and (2) offer you this license which gives you legal permission to copy, distribute and/or modify the software.

Also, for each author's protection and ours, we want to make certain that everyone understands that there is no warranty for this free software. If the software is modified by someone else and passed on, we want its recipients to know that what they have is not the original, so that any problems introduced by others will not reflect on the original authors' reputations.

Finally, any free program is threatened constantly by software patents. We wish to avoid the danger that redistributors of a free program will individually obtain patent licenses, in effect making the program proprietary. To prevent this, we have made it clear that any patent must be licensed for everyone's free use or not licensed at all.

The precise terms and conditions for copying, distribution and modification follow.

GNU GENERAL PUBLIC LICENSE

TERMS AND CONDITIONS FOR COPYING, DISTRIBUTION AND MODIFICATION

0. This License applies to any program or other work which contains a notice placed by the copyright holder saying it may be distributed under the terms of this General Public License. The "Program", below, refers to any such program or work, and a "work based on the Program" means either the Program or any derivative work under copyright law: that is to say, a work containing the Program or a portion of it, either verbatim or with modifications and/or translated into another language. (Hereinafter, translation is included without limitation in the term "modification".) Each licensee is addressed as "you".

Activities other than copying, distribution and modification are not covered by this License; they are outside its scope. The act of running the Program is not restricted, and the output from the Program is covered only if its contents constitute a work based on the Program (independent of having been made by running the Program). Whether that is true depends on what the Program does.

1. You may copy and distribute verbatim copies of the Program's source code as you receive it, in any medium, provided that you conspicuously and appropriately publish on each copy an appropriate copyright notice and disclaimer of warranty; keep intact all the notices that refer to this License and to the absence of any warranty; and give any other recipients of the Program a copy of this License along with the Program.

You may charge a fee for the physical act of transferring a copy, and you may at your option offer warranty protection in exchange for a fee.

2. You may modify your copy or copies of the Program or any portion of it, thus forming a work based on the Program, and copy and distribute such modifications or work under the terms of Section 1 above, provided that you also meet all of these conditions:
 - a) You must cause the modified files to carry prominent notices stating that you changed the files and the date of any change.

b) You must cause any work that you distribute or publish, that in whole or in part contains or is derived from the Program or any part thereof, to be licensed as a whole at no charge to all third parties under the terms of this License.

c) If the modified program normally reads commands interactively when run, you must cause it, when started running for such interactive use in the most ordinary way, to print or display an announcement including an appropriate copyright notice and a notice that there is no warranty (or else, saying that you provide a warranty) and that users may redistribute the program under these conditions, and telling the user how to view a copy of this License. (Exception: if the Program itself is interactive but does not normally print such an announcement, your work based on the Program is not required to print an announcement.)

These requirements apply to the modified work as a whole. If identifiable sections of that work are not derived from the Program, and can be reasonably considered independent and separate works in themselves, then this License, and its terms, do not apply to those sections when you distribute them as separate works. But when you distribute the same sections as part of a whole which is a work based on the Program, the distribution of the whole must be on the terms of this License, whose permissions for other licensees extend to the entire whole, and thus to each and every part regardless of who wrote it.

Thus, it is not the intent of this section to claim rights or contest your rights to work written entirely by you; rather, the intent is to exercise the right to control the distribution of derivative or collective works based on the Program.

In addition, mere aggregation of another work not based on the Program with the Program (or with a work based on the Program) on a volume of a storage or distribution medium does not bring the other work under the scope of this License.

3. You may copy and distribute the Program (or a work based on it, under Section 2) in object code or executable form under the terms of Sections 1 and 2 above provided that you also do one of the following:
 - a) Accompany it with the complete corresponding machine-readable source code, which must be distributed under the terms of Sections 1 and 2 above on a medium customarily used for software interchange; or,
 - b) Accompany it with a written offer, valid for at least three years, to give any third party, for a charge no more than your cost of physically performing source distribution, a complete machine-readable copy of the corresponding source code, to be distributed under the terms of Sections 1 and 2 above on a medium customarily used for software interchange; or,

c) Accompany it with the information you received as to the offer to distribute corresponding source code. (This alternative is allowed only for noncommercial distribution and only if you received the program in object code or executable form with such an offer, in accord with Subsection b above.)

The source code for a work means the preferred form of the work for making modifications to it. For an executable work, complete source code means all the source code for all modules it contains, plus any associated interface definition files, plus the scripts used to control compilation and installation of the executable. However, as a special exception, the source code distributed need not include anything that is normally distributed (in either source or binary form) with the major components (compiler, kernel, and so on) of the operating system on which the executable runs, unless that component itself accompanies the executable.

If distribution of executable or object code is made by offering access to copy from a designated place, then offering equivalent access to copy the source code from the same place counts as distribution of the source code, even though third parties are not compelled to copy the source along with the object code.

4. You may not copy, modify, sublicense, or distribute the Program except as expressly provided under this License. Any attempt otherwise to copy, modify, sublicense or distribute the Program is void, and will automatically terminate your rights under this License. However, parties who have received copies, or rights, from you under this License will not have their licenses terminated so long as such parties remain in full compliance.
5. You are not required to accept this License, since you have not signed it. However, nothing else grants you permission to modify or distribute the Program or its derivative works. These actions are prohibited by law if you do not accept this License. Therefore, by modifying or distributing the Program (or any work based on the Program), you indicate your acceptance of this License to do so, and all its terms and conditions for copying, distributing or modifying the Program or works based on it.
6. Each time you redistribute the Program (or any work based on the Program), the recipient automatically receives a license from the original licensor to copy, distribute or modify the Program subject to these terms and conditions. You may not impose any further restrictions on the recipients' exercise of the rights granted herein. You are not responsible for enforcing compliance by third parties to this License.

7. If, as a consequence of a court judgment or allegation of patent infringement or for any other reason (not limited to patent issues), conditions are imposed on you (whether by court order, agreement or otherwise) that contradict the conditions of this License, they do not excuse you from the conditions of this License. If you cannot distribute so as to satisfy simultaneously your obligations under this License and any other pertinent obligations, then as a consequence you may not distribute the Program at all. For example, if a patent license would not permit royalty-free redistribution of the Program by all those who receive copies directly or indirectly through you, then the only way you could satisfy both it and this License would be to refrain entirely from distribution of the Program.

If any portion of this section is held invalid or unenforceable under any particular circumstance, the balance of the section is intended to apply and the section as a whole is intended to apply in other circumstances.

It is not the purpose of this section to induce you to infringe any patents or other property right claims or to contest validity of any such claims; this section has the sole purpose of protecting the integrity of the free software distribution system, which is implemented by public license practices. Many people have made generous contributions to the wide range of software distributed through that system in reliance on consistent application of that system; it is up to the author/donor to decide if he or she is willing to distribute software through any other system and a licensee cannot impose that choice.

This section is intended to make thoroughly clear what is believed to be a consequence of the rest of this License.

8. If the distribution and/or use of the Program is restricted in certain countries either by patents or by copyrighted interfaces, the original copyright holder who places the Program under this License may add an explicit geographical distribution limitation excluding those countries, so that distribution is permitted only in or among countries not thus excluded. In such case, this License incorporates the limitation as if written in the body of this License.
9. The Free Software Foundation may publish revised and/or new versions of the General Public License from time to time. Such new versions will be similar in spirit to the present version, but may differ in detail to address new problems or concerns.

Each version is given a distinguishing version number. If the Program specifies a version number of this License which applies to it and "any later version", you have the option of following the terms and conditions either of that version or of any later version published by the Free Software Foundation. If the Program does not specify a version number of this License, you may choose any version ever published by the Free Software Foundation.

10. If you wish to incorporate parts of the Program into other free programs whose distribution conditions are different, write to the author to ask for permission. For software which is copyrighted by the Free Software Foundation, write to the Free Software Foundation; we sometimes make exceptions for this. Our decision will be guided by the two goals of preserving the free status of all derivatives of our free software and of promoting the sharing and reuse of software generally.

NO WARRANTY

11. BECAUSE THE PROGRAM IS LICENSED FREE OF CHARGE, THERE IS NO WARRANTY FOR THE PROGRAM, TO THE EXTENT PERMITTED BY APPLICABLE LAW. EXCEPT WHEN OTHERWISE STATED IN WRITING THE COPYRIGHT HOLDERS AND/OR OTHER PARTIES PROVIDE THE PROGRAM "AS IS" WITHOUT WARRANTY OF ANY KIND, EITHER EXPRESSED OR IMPLIED, INCLUDING, BUT NOT LIMITED TO, THE IMPLIED WARRANTIES OF MERCHANTABILITY AND FITNESS FOR A PARTICULAR PURPOSE. THE ENTIRE RISK AS TO THE QUALITY AND PERFORMANCE OF THE PROGRAM IS WITH YOU. SHOULD THE PROGRAM PROVE DEFECTIVE, YOU ASSUME THE COST OF ALL NECESSARY SERVICING, REPAIR OR CORRECTION.
12. IN NO EVENT UNLESS REQUIRED BY APPLICABLE LAW OR AGREED TO IN WRITING WILL ANY COPYRIGHT HOLDER, OR ANY OTHER PARTY WHO MAY MODIFY AND/OR REDISTRIBUTE THE PROGRAM AS PERMITTED ABOVE, BE LIABLE TO YOU FOR DAMAGES, INCLUDING ANY GENERAL, SPECIAL, INCIDENTAL OR CONSEQUENTIAL DAMAGES ARISING OUT OF THE USE OR INABILITY TO USE THE PROGRAM (INCLUDING BUT NOT LIMITED TO LOSS OF DATA OR DATA BEING RENDERED INACCURATE OR LOSSES SUSTAINED BY YOU OR THIRD PARTIES OR A FAILURE OF THE PROGRAM TO OPERATE WITH ANY OTHER PROGRAMS), EVEN IF SUCH HOLDER OR OTHER PARTY HAS BEEN ADVISED OF THE POSSIBILITY OF SUCH DAMAGES.

END OF TERMS AND CONDITIONS

How to Apply These Terms to Your New Programs

If you develop a new program, and you want it to be of the greatest possible use to the public, the best way to achieve this is to make it free software which everyone can redistribute and change under these terms.

To do so, attach the following notices to the program. It is safest to attach them to the start of each source file to most effectively convey the exclusion of warranty; and each file should have at least the "copyright" line and a pointer to where the full notice is found.

<one line to give the program's name and a brief idea of what it does.>

Copyright (C) <year> <name of author>

This program is free software; you can redistribute it and/or modify it under the terms of the GNU General Public License as published by the Free Software Foundation; either version 2 of the License, or (at your option) any later version.

This program is distributed in the hope that it will be useful, but WITHOUT ANY WARRANTY; without even the implied warranty of MERCHANTABILITY or FITNESS FOR A PARTICULAR PURPOSE. See the GNU General Public License for more details.

You should have received a copy of the GNU General Public License along with this program; if not, write to the Free Software Foundation, Inc., 51 Franklin Street, Fifth Floor, Boston, MA 02110-1301 USA.

Also add information on how to contact you by electronic and paper mail.

If the program is interactive, make it output a short notice like this when it starts in an interactive mode:

```
Gnomovision version 69, Copyright (C) year name of author
```

Gnomovision comes with ABSOLUTELY NO WARRANTY; for details type ``show w'`. This is free software, and you are welcome to redistribute it under certain conditions; type ``show c'` for details.

The hypothetical commands ``show w'` and ``show c'` should show the appropriate parts of the General Public License. Of course, the commands you use may be called something other than ``show w'` and ``show c'`; they could even be mouse-clicks or menu items--whatever suits your program.

You should also get your employer (if you work as a programmer) or your school, if any, to sign a "copyright disclaimer" for the program, if necessary. Here is a sample; alter the names:

Yoyodyne, Inc., hereby disclaims all copyright interest in the program 'Gnomovision' (which makes passes at compilers) written by James Hacker.

```
<signature of Ty Coon>, 1 April 1989
```

Ty Coon, President of Vice

This General Public License does not permit incorporating your program into proprietary programs. If your program is a subroutine library, you may consider it more useful to permit linking proprietary applications with the library. If this is what you want to do, use the GNU Lesser General Public License instead of this License.

License for libpng

Pulse Secure Virtual Traffic Manager contains code from libpng – a PNG reference library. The following copyright notice applies:

Version: 1.2.57

License summary: MIT

Copyright:

COPYRIGHT NOTICE, DISCLAIMER, and LICENSE:

If you modify libpng you may insert additional notices immediately following this sentence.

This code is released under the libpng license.

libpng versions 1.0.7, July 1, 2000, through 1.2.56, December 17, 2015, are Copyright (c) 2000-2002, 2004, 2006-2015 Glenn Randers-Pehrson, are derived from libpng-1.0.6, and are distributed according to the same disclaimer and license as libpng-1.0.6 with the following individuals added to the list of Contributing Authors:

Simon-Pierre Cadieux

Eric S. Raymond

Cosmin Truta

Gilles Vollant

and with the following additions to the disclaimer:

There is no warranty against interference with your enjoyment of the library or against infringement. There is no warranty that our efforts or the library will fulfill any of your particular purposes or needs. This library is provided with all faults, and the entire risk of satisfactory quality, performance, accuracy, and effort is with the user.

libpng versions 0.97, January 1998, through 1.0.6, March 20, 2000, are Copyright (c) 1998-2000 Glenn Randers-Pehrson, are derived from libpng-0.96, and are distributed according to the same disclaimer and license as libpng-0.96, with the following individuals added to the list of Contributing Authors:

Tom Lane

Glenn Randers-Pehrson

Willem van Schaik

libpng versions 0.89, June 1996, through 0.96, May 1997, are Copyright (c) 1996-1997 Andreas Dilger, are derived from libpng-0.88, and are distributed according to the same disclaimer and license as libpng-0.88, with the following individuals added to the list of Contributing Authors:

John Bowler

Kevin Bracey

Sam Bushell

Magnus Holmgren

Greg Roelofs

Tom Tanner

libpng versions 0.5, May 1995, through 0.88, January 1996, are Copyright (c) 1995-1996 Guy Eric Schalnat, Group 42, Inc.

For the purposes of this copyright and license, "Contributing Authors" is defined as the following set of individuals:

Andreas Dilger

Dave Martindale

Guy Eric Schalnat

Paul Schmidt

Tim Wegner

The PNG Reference Library is supplied "AS IS". The Contributing Authors and Group 42, Inc. disclaim all warranties, expressed or implied, including, without limitation, the warranties of merchantability and of fitness for any purpose. The Contributing Authors and Group 42, Inc. assume no liability for direct, indirect, incidental, special, exemplary, or consequential damages, which may result from the use of the PNG Reference Library, even if advised of the possibility of such damage.

Permission is hereby granted to use, copy, modify, and distribute this source code, or portions hereof, for any purpose, without fee, subject to the following restrictions:

1. The origin of this source code must not be misrepresented.
2. Altered versions must be plainly marked as such and must not be misrepresented as being the original source.
3. This Copyright notice may not be removed or altered from any source or altered source distribution.

The Contributing Authors and Group 42, Inc. specifically permit, without fee, and encourage the use of this source code as a component to supporting the PNG file format in commercial products. If you use this source code in a product, acknowledgment is not required but would be appreciated.

END OF COPYRIGHT NOTICE, DISCLAIMER, and LICENSE.

License for Perl

Pulse Secure Virtual Traffic Manager contains a modified version of Perl. To see details of the modified packages that fall under this license attribution, refer to the instructions in the "Open Source Software Licenses" chapter of the Pulse Secure Virtual Traffic Manager: Installation and Getting Started Guide applicable to your product variant.

The following copyright notice applies:

Version: 5.10.1

License summary: Perl Artistic License v1.0

Copyright:

The "Artistic License"

Preamble

The intent of this document is to state the conditions under which a Package may be copied, such that the Copyright Holder maintains some semblance of artistic control over the development of the package, while giving the users of the package the right to use and distribute the Package in a more-or-less customary fashion, plus the right to make reasonable modifications.

Definitions:

- "Package" refers to the collection of files distributed by the Copyright Holder, and derivatives of that collection of files created through textual modification.
- "Standard Version" refers to such a Package if it has not been modified, or has been modified in accordance with the wishes of the Copyright Holder as specified below.
- "Copyright Holder" is whoever is named in the copyright or copyrights for the package.
- "You" is you, if you're thinking about copying or distributing this Package.

- "Reasonable copying fee" is whatever you can justify on the basis of media cost, duplication charges, time of people involved, and so on. (You will not be required to justify it to the Copyright Holder, but only to the computing community at large as a market that must bear the fee.)
 - "Freely Available" means that no fee is charged for the item itself, though there may be fees involved in handling the item. It also means that recipients of the item may redistribute it under the same conditions they received it.
1. You may make and give away verbatim copies of the source form of the Standard Version of this Package without restriction, provided that you duplicate all of the original copyright notices and associated disclaimers.
 2. You may apply bug fixes, portability fixes and other modifications derived from the Public Domain or from the Copyright Holder. A Package modified in such a way shall still be considered the Standard Version.
 3. You may otherwise modify your copy of this Package in any way, provided that you insert a prominent notice in each changed file stating how and when you changed that file, and provided that you do at least ONE of the following:
 - a) place your modifications in the Public Domain or otherwise make them Freely Available, such as by posting said modifications to Usenet or an equivalent medium, or placing the modifications on a major archive site such as uunet.uu.net, or by allowing the Copyright Holder to include your modifications in the Standard Version of the Package.
 - b) use the modified Package only within your corporation or organization.
 - c) rename any non-standard executables so the names do not conflict with standard executables, which must also be provided, and provide a separate manual page for each non-standard executable that clearly documents how it differs from the Standard Version.
 - d) make other distribution arrangements with the Copyright Holder.
 4. You may distribute the programs of this Package in object code or executable form, provided that you do at least ONE of the following:
 - a) distribute a Standard Version of the executables and library files, together with instructions (in the manual page or equivalent) on where to get the Standard Version.
 - b) accompany the distribution with the machine-readable source of the Package with your modifications.

- c) give non-standard executables non-standard names, and clearly document the differences in manual pages (or equivalent), together with instructions on where to get the Standard Version.
- d) make other distribution arrangements with the Copyright Holder.
5. You may charge a reasonable copying fee for any distribution of this Package. You may charge any fee you choose for support of this Package. You may not charge a fee for this Package itself. However, you may distribute this Package in aggregate with other (possibly commercial) programs as part of a larger (possibly commercial) software distribution provided that you do not advertise this Package as a product of your own. You may embed this Package's interpreter within an executable of yours (by linking); this shall be construed as a mere form of aggregation, provided that the complete Standard Version of the interpreter is so embedded.
 6. The scripts and library files supplied as input to or produced as output from the programs of this Package do not automatically fall under the copyright of this Package, but belong to whoever generated them, and may be sold commercially, and may be aggregated with this Package. If such scripts or library files are aggregated with this Package via the so-called "undump" or "unexec" methods of producing a binary executable image, then distribution of such an image shall neither be construed as a distribution of this Package nor shall it fall under the restrictions of Paragraphs 3 and 4, provided that you do not represent such an executable image as a Standard Version of this Package.
 7. C subroutines (or comparably compiled subroutines in other languages) supplied by you and linked into this Package in order to emulate subroutines and variables of the language defined by this Package shall not be considered part of this Package, but are the equivalent of input as in Paragraph 6, provided these subroutines do not change the language in any way that would cause it to fail the regression tests for the language.
 8. Aggregation of this Package with a commercial distribution is always permitted provided that the use of this Package is embedded; that is, when no overt attempt is made to make this Package's interfaces visible to the end user of the commercial distribution. Such use shall not be construed as a distribution of this Package.
 9. The name of the Copyright Holder may not be used to endorse or promote products derived from this software without specific prior written permission.
 10. THIS PACKAGE IS PROVIDED "AS IS" AND WITHOUT ANY EXPRESS OR IMPLIED WARRANTIES, INCLUDING, WITHOUT LIMITATION, THE IMPLIED WARRANTIES OF MERCHANTABILITY AND FITNESS FOR A PARTICULAR PURPOSE.

The End

License for xmlsec

Pulse Secure Virtual Traffic Manager contains code from xmlsec – an XML Security Library based on LibXML2. The following copyright notice applies:

Version: 1.2.24

License summary: MIT

Copyright:

xmlsec, xmlsec-openssl, xmlsec-gnutls, xmlsec-gcrypt libraries

Copyright (C) 2002-2016 Aleksey Sanin <aleksey@aleksey.com>. All Rights Reserved.

Permission is hereby granted, free of charge, to any person obtaining a copy of this software and associated documentation files (the "Software"), to deal in the Software without restriction, including without limitation the rights to use, copy, modify, merge, publish, distribute, sublicense, and/or sell copies of the Software, and to permit persons to whom the Software is furnished to do so, subject to the following conditions:

The above copyright notice and this permission notice shall be included in all copies or substantial portions of the Software.

THE SOFTWARE IS PROVIDED "AS IS", WITHOUT WARRANTY OF ANY KIND, EXPRESS OR IMPLIED, INCLUDING BUT NOT LIMITED TO THE WARRANTIES OF MERCHANTABILITY, FITNESS FOR A PARTICULAR PURPOSE AND NONINFRINGEMENT. IN NO EVENT SHALL THE ALEKSEY SANIN BE LIABLE FOR ANY CLAIM, DAMAGES OR OTHER LIABILITY, WHETHER IN AN ACTION OF CONTRACT, TORT OR OTHERWISE, ARISING FROM, OUT OF OR IN CONNECTION WITH THE SOFTWARE OR THE USE OR OTHER DEALINGS IN THE SOFTWARE.

Except as contained in this notice, the name of Aleksey Sanin shall not be used in advertising or otherwise to promote the sale, use or other dealings in this Software without prior written authorization from him.

xmlsec-nss library

Copyright (C) 2002-2016 Aleksey Sanin <aleksey@aleksey.com>. All Rights Reserved.

Copyright (c) 2003 America Online, Inc. All rights reserved.

Permission is hereby granted, free of charge, to any person obtaining a copy of this software and associated documentation files (the "Software"), to deal in the Software without restriction, including without limitation the rights to use, copy, modify, merge, publish, distribute, sublicense, and/or sell copies of the Software, and to permit persons to whom the Software is furnished to do so, subject to the following conditions:

The above copyright notice and this permission notice shall be included in all copies or substantial portions of the Software.

Portions of the Software were created using source code and/or APIs governed by the Mozilla Public License (MPL). The MPL is available at <http://www.mozilla.org/MPL/MPL-1.1.html>. The MPL permits such portions to be distributed with code not governed by MPL, as long as the requirements of MPL are fulfilled for such portions.

THE SOFTWARE IS PROVIDED "AS IS", WITHOUT WARRANTY OF ANY KIND, EXPRESS OR IMPLIED, INCLUDING BUT NOT LIMITED TO THE WARRANTIES OF MERCHANTABILITY, FITNESS FOR A PARTICULAR PURPOSE AND NONINFRINGEMENT. IN NO EVENT SHALL THE ALEKSEY SANIN BE LIABLE FOR ANY CLAIM, DAMAGES OR OTHER LIABILITY, WHETHER IN AN ACTION OF CONTRACT, TORT OR OTHERWISE, ARISING FROM, OUT OF OR IN CONNECTION WITH THE SOFTWARE OR THE USE OR OTHER DEALINGS IN THE SOFTWARE.

Except as contained in this notice, the name of Aleksey Sanin shall not be used in advertising or otherwise to promote the sale, use or other dealings in this Software without prior written authorization from him.

xmlsec-mscrypto library

Copyright (C) 2002-2016 Aleksey Sanin <aleksey@aleksey.com>. All Rights Reserved.

Copyright (C) 2003 Cordys R&D BV, All rights reserved.

Copyright (C) 2007 Roumen Petrov.

Copyright (c) 2005-2006 Cryptocom LTD (<http://www.cryptocom.ru>).

Permission is hereby granted, free of charge, to any person obtaining a copy of this software and associated documentation files (the "Software"), to deal in the Software without restriction, including without limitation the rights to use, copy, modify, merge, publish, distribute, sublicense, and/or sell copies of the Software, and to permit persons to whom the Software is furnished to do so, subject to the following conditions:

The above copyright notice and this permission notice shall be included in all copies or substantial portions of the Software.

THE SOFTWARE IS PROVIDED "AS IS", WITHOUT WARRANTY OF ANY KIND, EXPRESS OR IMPLIED, INCLUDING BUT NOT LIMITED TO THE WARRANTIES OF MERCHANTABILITY, FITNESS FOR A PARTICULAR PURPOSE AND NONINFRINGEMENT. IN NO EVENT SHALL THE ALEKSEY SANIN BE LIABLE FOR ANY CLAIM, DAMAGES OR OTHER LIABILITY, WHETHER IN AN ACTION OF CONTRACT, TORT OR OTHERWISE, ARISING FROM, OUT OF OR IN CONNECTION WITH THE SOFTWARE OR THE USE OR OTHER DEALINGS IN THE SOFTWARE.

Except as contained in this notice, the name of Aleksey Sanin shall not be used in advertising or otherwise to promote the sale, use or other dealings in this Software without prior written authorization from him.

References

* AOL

<http://www.aleksey.com/pipermail/xmlsec/2003/005488.html>

<http://www.aleksey.com/pipermail/xmlsec/attachments/20030729/0e25648e/attachment.htm>

* Cordys R&D BV

<http://www.aleksey.com/pipermail/xmlsec/2003/005581.html>

* Cryptocom LTD

<http://www.aleksey.com/pipermail/xmlsec/2006/007410.html>

License for Itrace

Pulse Secure Virtual Traffic Manager contains code from Itrace – a program used to track runtime library calls in dynamically-linked programs. The following copyright notice applies:

Version: 0.7.3

License summary: GPLv2

Copyright:

GNU GENERAL PUBLIC LICENSE

Version 2, June 1991

Copyright (C) 1989, 1991 Free Software Foundation, Inc.

51 Franklin St, Fifth Floor, Boston, MA 02110-1301 USA

Everyone is permitted to copy and distribute verbatim copies of this license document, but changing it is not allowed.

Preamble

The licenses for most software are designed to take away your freedom to share and change it. By contrast, the GNU General Public License is intended to guarantee your freedom to share and change free software--to make sure the software is free for all its users. This General Public License applies to most of the Free Software Foundation's software and to any other program whose authors commit to using it. (Some other Free Software Foundation software is covered by the GNU Library General Public License instead.) You can apply it to your programs, too.

When we speak of free software, we are referring to freedom, not price. Our General Public Licenses are designed to make sure that you have the freedom to distribute copies of free software (and charge for this service if you wish), that you receive source code or can get it if you want it, that you can change the software or use pieces of it in new free programs; and that you know you can do these things.

To protect your rights, we need to make restrictions that forbid anyone to deny you these rights or to ask you to surrender the rights. These restrictions translate to certain responsibilities for you if you distribute copies of the software, or if you modify it.

For example, if you distribute copies of such a program, whether gratis or for a fee, you must give the recipients all the rights that you have. You must make sure that they, too, receive or can get the source code. And you must show them these terms so they know their rights.

We protect your rights with two steps: (1) copyright the software, and (2) offer you this license which gives you legal permission to copy, distribute and/or modify the software.

Also, for each author's protection and ours, we want to make certain that everyone understands that there is no warranty for this free software. If the software is modified by someone else and passed on, we want its recipients to know that what they have is not the original, so that any problems introduced by others will not reflect on the original authors' reputations.

Finally, any free program is threatened constantly by software patents. We wish to avoid the danger that redistributors of a free program will individually obtain patent licenses, in effect making the program proprietary. To prevent this, we have made it clear that any patent must be licensed for everyone's free use or not licensed at all.

The precise terms and conditions for copying, distribution and modification follow.

GNU GENERAL PUBLIC LICENSE

TERMS AND CONDITIONS FOR COPYING, DISTRIBUTION AND MODIFICATION

0. This License applies to any program or other work which contains a notice placed by the copyright holder saying it may be distributed under the terms of this General Public License. The "Program", below, refers to any such program or work, and a "work based on the Program" means either the Program or any derivative work under copyright law: that is to say, a work containing the Program or a portion of it, either verbatim or with modifications and/or translated into another language. (Hereinafter, translation is included without limitation in the term "modification".) Each licensee is addressed as "you".

Activities other than copying, distribution and modification are not covered by this License; they are outside its scope. The act of running the Program is not restricted, and the output from the Program is covered only if its contents constitute a work based on the Program (independent of having been made by running the Program). Whether that is true depends on what the Program does.

1. You may copy and distribute verbatim copies of the Program's source code as you receive it, in any medium, provided that you conspicuously and appropriately publish on each copy an appropriate copyright notice and disclaimer of warranty; keep intact all the notices that refer to this License and to the absence of any warranty; and give any other recipients of the Program a copy of this License along with the Program.

You may charge a fee for the physical act of transferring a copy, and you may at your option offer warranty protection in exchange for a fee.

2. You may modify your copy or copies of the Program or any portion of it, thus forming a work based on the Program, and copy and distribute such modifications or work under the terms of Section 1 above, provided that you also meet all of these conditions:

- a) You must cause the modified files to carry prominent notices stating that you changed the files and the date of any change.
- b) You must cause any work that you distribute or publish, that in whole or in part contains or is derived from the Program or any part thereof, to be licensed as a whole at no charge to all third parties under the terms of this License.
- c) If the modified program normally reads commands interactively when run, you must cause it, when started running for such interactive use in the most ordinary way, to print or display an announcement including an appropriate copyright notice and a notice that there is no warranty (or else, saying that you provide a warranty) and that users may redistribute the program under these conditions, and telling the user how to view a copy of this License. (Exception: if the Program itself is interactive but does not normally print such an announcement, your work based on the Program is not required to print an announcement.)

These requirements apply to the modified work as a whole. If identifiable sections of that work are not derived from the Program, and can be reasonably considered independent and separate works in themselves, then this License, and its terms, do not apply to those sections when you distribute them as separate works. But when you distribute the same sections as part of a whole which is a work based on the Program, the distribution of the whole must be on the terms of this License, whose permissions for other licensees extend to the entire whole, and thus to each and every part regardless of who wrote it.

Thus, it is not the intent of this section to claim rights or contest your rights to work written entirely by you; rather, the intent is to exercise the right to control the distribution of derivative or collective works based on the Program.

In addition, mere aggregation of another work not based on the Program with the Program (or with a work based on the Program) on a volume of a storage or distribution medium does not bring the other work under the scope of this License.

3. You may copy and distribute the Program (or a work based on it, under Section 2) in object code or executable form under the terms of Sections 1 and 2 above provided that you also do one of the following:

- a) Accompany it with the complete corresponding machine-readable source code, which must be distributed under the terms of Sections 1 and 2 above on a medium customarily used for software interchange; or,

b) Accompany it with a written offer, valid for at least three years, to give any third party, for a charge no more than your cost of physically performing source distribution, a complete machine-readable copy of the corresponding source code, to be distributed under the terms of Sections 1 and 2 above on a medium customarily used for software interchange; or,

c) Accompany it with the information you received as to the offer to distribute corresponding source code. (This alternative is allowed only for noncommercial distribution and only if you received the program in object code or executable form with such an offer, in accord with Subsection b above.)

The source code for a work means the preferred form of the work for making modifications to it. For an executable work, complete source code means all the source code for all modules it contains, plus any associated interface definition files, plus the scripts used to control compilation and installation of the executable. However, as a special exception, the source code distributed need not include anything that is normally distributed (in either source or binary form) with the major components (compiler, kernel, and so on) of the operating system on which the executable runs, unless that component itself accompanies the executable.

If distribution of executable or object code is made by offering access to copy from a designated place, then offering equivalent access to copy the source code from the same place counts as distribution of the source code, even though third parties are not compelled to copy the source along with the object code.

4. You may not copy, modify, sublicense, or distribute the Program except as expressly provided under this License. Any attempt otherwise to copy, modify, sublicense or distribute the Program is void, and will automatically terminate your rights under this License. However, parties who have received copies, or rights, from you under this License will not have their licenses terminated so long as such parties remain in full compliance.

5. You are not required to accept this License, since you have not signed it. However, nothing else grants you permission to modify or distribute the Program or its derivative works. These actions are prohibited by law if you do not accept this License. Therefore, by modifying or distributing the Program (or any work based on the Program), you indicate your acceptance of this License to do so, and all its terms and conditions for copying, distributing or modifying the Program or works based on it.

6. Each time you redistribute the Program (or any work based on the Program), the recipient automatically receives a license from the original licensor to copy, distribute or modify the Program subject to these terms and conditions. You may not impose any further restrictions on the recipients' exercise of the rights granted herein. You are not responsible for enforcing compliance by third parties to this License.

7. If, as a consequence of a court judgment or allegation of patent infringement or for any other reason (not limited to patent issues), conditions are imposed on you (whether by court order, agreement or otherwise) that contradict the conditions of this License, they do not excuse you from the conditions of this License. If you cannot distribute so as to satisfy simultaneously your obligations under this License and any other pertinent obligations, then as a consequence you may not distribute the Program at all. For example, if a patent license would not permit royalty-free redistribution of the Program by all those who receive copies directly or indirectly through you, then the only way you could satisfy both it and this License would be to refrain entirely from distribution of the Program.

If any portion of this section is held invalid or unenforceable under any particular circumstance, the balance of the section is intended to apply and the section as a whole is intended to apply in other circumstances.

It is not the purpose of this section to induce you to infringe any patents or other property right claims or to contest validity of any such claims; this section has the sole purpose of protecting the integrity of the free software distribution system, which is implemented by public license practices. Many people have made generous contributions to the wide range of software distributed through that system in reliance on consistent application of that system; it is up to the author/donor to decide if he or she is willing to distribute software through any other system and a licensee cannot impose that choice.

This section is intended to make thoroughly clear what is believed to be a consequence of the rest of this License.

8. If the distribution and/or use of the Program is restricted in certain countries either by patents or by copyrighted interfaces, the original copyright holder who places the Program under this License may add an explicit geographical distribution limitation excluding those countries, so that distribution is permitted only in or among countries not thus excluded. In such case, this License incorporates the limitation as if written in the body of this License.

9. The Free Software Foundation may publish revised and/or new versions of the General Public License from time to time. Such new versions will be similar in spirit to the present version, but may differ in detail to address new problems or concerns.

Each version is given a distinguishing version number. If the Program specifies a version number of this License which applies to it and "any later version", you have the option of following the terms and conditions either of that version or of any later version published by the Free Software Foundation. If the Program does not specify a version number of this License, you may choose any version ever published by the Free Software Foundation.

10. If you wish to incorporate parts of the Program into other free programs whose distribution conditions are different, write to the author to ask for permission. For software which is copyrighted by the Free Software Foundation, write to the Free Software Foundation; we sometimes make exceptions for this. Our decision will be guided by the two goals of preserving the free status of all derivatives of our free software and of promoting the sharing and reuse of software generally.

NO WARRANTY

11. BECAUSE THE PROGRAM IS LICENSED FREE OF CHARGE, THERE IS NO WARRANTY FOR THE PROGRAM, TO THE EXTENT PERMITTED BY APPLICABLE LAW. EXCEPT WHEN OTHERWISE STATED IN WRITING THE COPYRIGHT HOLDERS AND/OR OTHER PARTIES PROVIDE THE PROGRAM "AS IS" WITHOUT WARRANTY OF ANY KIND, EITHER EXPRESSED OR IMPLIED, INCLUDING, BUT NOT LIMITED TO, THE IMPLIED WARRANTIES OF MERCHANTABILITY AND FITNESS FOR A PARTICULAR PURPOSE. THE ENTIRE RISK AS TO THE QUALITY AND PERFORMANCE OF THE PROGRAM IS WITH YOU. SHOULD THE PROGRAM PROVE DEFECTIVE, YOU ASSUME THE COST OF ALL NECESSARY SERVICING, REPAIR OR CORRECTION.

12. IN NO EVENT UNLESS REQUIRED BY APPLICABLE LAW OR AGREED TO IN WRITING WILL ANY COPYRIGHT HOLDER, OR ANY OTHER PARTY WHO MAY MODIFY AND/OR REDISTRIBUTE THE PROGRAM AS PERMITTED ABOVE, BE LIABLE TO YOU FOR DAMAGES, INCLUDING ANY GENERAL, SPECIAL, INCIDENTAL OR CONSEQUENTIAL DAMAGES ARISING OUT OF THE USE OR INABILITY TO USE THE PROGRAM (INCLUDING BUT NOT LIMITED TO LOSS OF DATA OR DATA BEING RENDERED INACCURATE OR LOSSES SUSTAINED BY YOU OR THIRD PARTIES OR A FAILURE OF THE PROGRAM TO OPERATE WITH ANY OTHER PROGRAMS), EVEN IF SUCH HOLDER OR OTHER PARTY HAS BEEN ADVISED OF THE POSSIBILITY OF SUCH DAMAGES.

END OF TERMS AND CONDITIONS

How to Apply These Terms to Your New Programs

If you develop a new program, and you want it to be of the greatest possible use to the public, the best way to achieve this is to make it free software which everyone can redistribute and change under these terms.

To do so, attach the following notices to the program. It is safest to attach them to the start of each source file to most effectively convey the exclusion of warranty; and each file should have at least the "copyright" line and a pointer to where the full notice is found.

<one line to give the program's name and a brief idea of what it does.>

Copyright (C) <year> <name of author>

This program is free software; you can redistribute it and/or modify it under the terms of the GNU General Public License as published by the Free Software Foundation; either version 2 of the License, or (at your option) any later version.

This program is distributed in the hope that it will be useful, but WITHOUT ANY WARRANTY; without even the implied warranty of MERCHANTABILITY or FITNESS FOR A PARTICULAR PURPOSE. See the GNU General Public License for more details.

You should have received a copy of the GNU General Public License along with this program; if not, write to the Free Software Foundation, Inc., 51 Franklin St, Fifth Floor, Boston, MA 02110-1301 USA

Also add information on how to contact you by electronic and paper mail.

If the program is interactive, make it output a short notice like this when it starts in an interactive mode:

```
Gnomovision version 69, Copyright (C) year name of author
```

```
Gnomovision comes with ABSOLUTELY NO WARRANTY; for details type `show w'.
```

```
This is free software, and you are welcome to redistribute it under certain conditions; type `show c' for details.
```

The hypothetical commands ``show w'` and ``show c'` should show the appropriate parts of the General Public License. Of course, the commands you use may be called something other than ``show w'` and ``show c'`; they could even be mouse-clicks or menu items--whatever suits your program.

You should also get your employer (if you work as a programmer) or your school, if any, to sign a "copyright disclaimer" for the program, if necessary. Here is a sample; alter the names:

```
Yoyodyne, Inc., hereby disclaims all copyright interest in the program `Gnomovision' (which makes passes at compilers) written by James Hacker.
```

```
<signature of Ty Coon>, 1 April 1989
```

```
Ty Coon, President of Vice
```

This General Public License does not permit incorporating your program into proprietary programs. If your program is a subroutine library, you may consider it more useful to permit linking proprietary applications with the library. If this is what you want to do, use the GNU Library General Public License instead of this License.

License for YAML::XS

Pulse Secure Virtual Traffic Manager contains code from YAML::XS – Perl YAML Serialization using XS and libyaml. The following copyright notice applies:

Version: 0.74

License summary: Perl Artistic License v1.0

Copyright:

Copyright 2007-2018. Ingy döt Net.

The "Artistic License"

Preamble

The intent of this document is to state the conditions under which a Package may be copied, such that the Copyright Holder maintains some semblance of artistic control over the development of the package, while giving the users of the package the right to use and distribute the Package in a more-or-less customary fashion, plus the right to make reasonable modifications.

Definitions:

- "Package" refers to the collection of files distributed by the Copyright Holder, and derivatives of that collection of files created through textual modification.
- "Standard Version" refers to such a Package if it has not been modified, or has been modified in accordance with the wishes of the Copyright Holder as specified below.
- "Copyright Holder" is whoever is named in the copyright or copyrights for the package.
- "You" is you, if you're thinking about copying or distributing this Package.
- "Reasonable copying fee" is whatever you can justify on the basis of media cost, duplication charges, time of people involved, and so on. (You will not be required to justify it to the Copyright Holder, but only to the computing community at large as a market that must bear the fee.)
- "Freely Available" means that no fee is charged for the item itself, though there may be fees involved in handling the item. It also means that recipients of the item may redistribute it under the same conditions they received it.

1. You may make and give away verbatim copies of the source form of the Standard Version of this Package without restriction, provided that you duplicate all of the original copyright notices and associated disclaimers.
2. You may apply bug fixes, portability fixes and other modifications derived from the Public Domain or from the Copyright Holder. A Package modified in such a way shall still be considered the Standard Version.
3. You may otherwise modify your copy of this Package in any way, provided that you insert a prominent notice in each changed file stating how and when you changed that file, and provided that you do at least ONE of the following:
 - a) place your modifications in the Public Domain or otherwise make them Freely Available, such as by posting said modifications to Usenet or an equivalent medium, or placing the modifications on a major archive site such as uunet.uu.net, or by allowing the Copyright Holder to include your modifications in the Standard Version of the Package.
 - b) use the modified Package only within your corporation or organization.
 - c) rename any non-standard executables so the names do not conflict with standard executables, which must also be provided, and provide a separate manual page for each non-standard executable that clearly documents how it differs from the Standard Version.
 - d) make other distribution arrangements with the Copyright Holder.
4. You may distribute the programs of this Package in object code or executable form, provided that you do at least ONE of the following:
 - a) distribute a Standard Version of the executables and library files, together with instructions (in the manual page or equivalent) on where to get the Standard Version.
 - b) accompany the distribution with the machine-readable source of the Package with your modifications.
 - c) give non-standard executables non-standard names, and clearly document the differences in manual pages (or equivalent), together with instructions on where to get the Standard Version.
 - d) make other distribution arrangements with the Copyright Holder.

5. You may charge a reasonable copying fee for any distribution of this Package. You may charge any fee you choose for support of this Package. You may not charge a fee for this Package itself. However, you may distribute this Package in aggregate with other (possibly commercial) programs as part of a larger (possibly commercial) software distribution provided that you do not advertise this Package as a product of your own. You may embed this Package's interpreter within an executable of yours (by linking); this shall be construed as a mere form of aggregation, provided that the complete Standard Version of the interpreter is so embedded.
6. The scripts and library files supplied as input to or produced as output from the programs of this Package do not automatically fall under the copyright of this Package, but belong to whoever generated them, and may be sold commercially, and may be aggregated with this Package. If such scripts or library files are aggregated with this Package via the so-called "undump" or "unexec" methods of producing a binary executable image, then distribution of such an image shall neither be construed as a distribution of this Package nor shall it fall under the restrictions of Paragraphs 3 and 4, provided that you do not represent such an executable image as a Standard Version of this Package.
7. C subroutines (or comparably compiled subroutines in other languages) supplied by you and linked into this Package in order to emulate subroutines and variables of the language defined by this Package shall not be considered part of this Package, but are the equivalent of input as in Paragraph 6, provided these subroutines do not change the language in any way that would cause it to fail the regression tests for the language.
8. Aggregation of this Package with a commercial distribution is always permitted provided that the use of this Package is embedded; that is, when no overt attempt is made to make this Package's interfaces visible to the end user of the commercial distribution. Such use shall not be construed as a distribution of this Package.
9. The name of the Copyright Holder may not be used to endorse or promote products derived from this software without specific prior written permission.
10. THIS PACKAGE IS PROVIDED "AS IS" AND WITHOUT ANY EXPRESS OR IMPLIED WARRANTIES, INCLUDING, WITHOUT LIMITATION, THE IMPLIED WARRANTIES OF MERCHANTABILITY AND FITNESS FOR A PARTICULAR PURPOSE.

The End

License for GeoNames

Pulse Secure Virtual Traffic Manager contains code from GeoNames – a geographical database (www.geonames.org). The following copyright notice applies:

License summary: Creative Commons Attribution 4.0

Copyright:

By exercising the Licensed Rights (defined below), You accept and agree to be bound by the terms and conditions of this Creative Commons Attribution 4.0 International Public License ("Public License"). To the extent this Public License may be interpreted as a contract, You are granted the Licensed Rights in consideration of Your acceptance of these terms and conditions, and the Licensor grants You such rights in consideration of benefits the Licensor receives from making the Licensed Material available under these terms and conditions.

Section 1 – Definitions.

- **Adapted Material** means material subject to Copyright and Similar Rights that is derived from or based upon the Licensed Material and in which the Licensed Material is translated, altered, arranged, transformed, or otherwise modified in a manner requiring permission under the Copyright and Similar Rights held by the Licensor. For purposes of this Public License, where the Licensed Material is a musical work, performance, or sound recording, Adapted Material is always produced where the Licensed Material is synched in timed relation with a moving image.
- **Adapter's License** means the license You apply to Your Copyright and Similar Rights in Your contributions to Adapted Material in accordance with the terms and conditions of this Public License.
- **Copyright and Similar Rights** means copyright and/or similar rights closely related to copyright including, without limitation, performance, broadcast, sound recording, and Sui Generis Database Rights, without regard to how the rights are labeled or categorized. For purposes of this Public License, the rights specified in Section 2(b)(1)-(2) are not Copyright and Similar Rights.
- **Effective Technological Measures** means those measures that, in the absence of proper authority, may not be circumvented under laws fulfilling obligations under Article 11 of the WIPO Copyright Treaty adopted on December 20, 1996, and/or similar international agreements.
- **Exceptions and Limitations** means fair use, fair dealing, and/or any other exception or limitation to Copyright and Similar Rights that applies to Your use of the Licensed Material.
- **Licensed Material** means the artistic or literary work, database, or other material to which the Licensor applied this Public License.

- **Licensed Rights** means the rights granted to You subject to the terms and conditions of this Public License, which are limited to all Copyright and Similar Rights that apply to Your use of the Licensed Material and that the Licensor has authority to license.
- **Licensor** means the individual(s) or entity(ies) granting rights under this Public License.
- **Share** means to provide material to the public by any means or process that requires permission under the Licensed Rights, such as reproduction, public display, public performance, distribution, dissemination, communication, or importation, and to make material available to the public including in ways that members of the public may access the material from a place and at a time individually chosen by them.
- **Sui Generis Database Rights** means rights other than copyright resulting from Directive 96/9/EC of the European Parliament and of the Council of 11 March 1996 on the legal protection of databases, as amended and/or succeeded, as well as other essentially equivalent rights anywhere in the world.
- **You** means the individual or entity exercising the Licensed Rights under this Public License. **Your** has a corresponding meaning.

Section 2 – Scope.

- **License grant.**
 - Subject to the terms and conditions of this Public License, the Licensor hereby grants You a worldwide, royalty-free, non-sublicensable, non-exclusive, irrevocable license to exercise the Licensed Rights in the Licensed Material to:
 - A. reproduce and Share the Licensed Material, in whole or in part; and
 - B. produce, reproduce, and Share Adapted Material.
 - *Exceptions and Limitations.* For the avoidance of doubt, where Exceptions and Limitations apply to Your use, this Public License does not apply, and You do not need to comply with its terms and conditions.
 - *Term.* The term of this Public License is specified in Section 6(a).

- *Media and formats; technical modifications allowed.* The Licensor authorizes You to exercise the Licensed Rights in all media and formats whether now known or hereafter created, and to make technical modifications necessary to do so. The Licensor waives and/or agrees not to assert any right or authority to forbid You from making technical modifications necessary to exercise the Licensed Rights, including technical modifications necessary to circumvent Effective Technological Measures. For purposes of this Public License, simply making modifications authorized by this Section 2(a)(4) never produces Adapted Material.

- *Downstream recipients.*

A. *Offer from the Licensor – Licensed Material.* Every recipient of the Licensed Material

automatically receives an offer from the Licensor to exercise the Licensed Rights under the terms and conditions of this Public License.

B. *No downstream restrictions.* You may not offer or impose any additional or different terms or

conditions on, or apply any Effective Technological Measures to, the Licensed Material if

doing so restricts exercise of the Licensed Rights by any recipient of the Licensed Material.

- *No endorsement.* Nothing in this Public License constitutes or may be construed as permission to assert or imply that You are, or that Your use of the Licensed Material is, connected with, or sponsored, endorsed, or granted official status by, the Licensor or others designated to receive attribution as provided in Section 3(a)(1)(A)(i).

- **Other rights.**

- Moral rights, such as the right of integrity, are not licensed under this Public License, nor are publicity, privacy, and/or other similar personality rights; however, to the extent possible, the Licensor waives and/or agrees not to assert any such rights held by the Licensor to the limited extent necessary to allow You to exercise the Licensed Rights, but not otherwise.

- Patent and trademark rights are not licensed under this Public License.

- To the extent possible, the Licensor waives any right to collect royalties from You for the exercise of the Licensed Rights, whether directly or through a collecting society under any voluntary or waivable statutory or compulsory licensing scheme. In all other cases the Licensor expressly reserves any right to collect such royalties.

Section 3 – License Conditions.

Your exercise of the Licensed Rights is expressly made subject to the following conditions.

- **Attribution.**
 - If You Share the Licensed Material (including in modified form), You must:
 - A. retain the following if it is supplied by the Licensor with the Licensed Material:
 - i. identification of the creator(s) of the Licensed Material and any others designated to receive attribution, in any reasonable manner requested by the Licensor (including by pseudonym if designated);
 - ii. a copyright notice;
 - iii. a notice that refers to this Public License;
 - iv. a notice that refers to the disclaimer of warranties;
 - v. a URI or hyperlink to the Licensed Material to the extent reasonably practicable;
 - B. indicate if You modified the Licensed Material and retain an indication of any previous modifications; and
 - C. indicate the Licensed Material is licensed under this Public License, and include the text of, or the URI or hyperlink to, this Public License.
 - You may satisfy the conditions in Section 3(a)(1) in any reasonable manner based on the medium, means, and context in which You Share the Licensed Material. For example, it may be reasonable to satisfy the conditions by providing a URI or hyperlink to a resource that includes the required information.

- If requested by the Licensor, You must remove any of the information required by Section 3(a)(1)(A) to the extent reasonably practicable.
- If You Share Adapted Material You produce, the Adapter's License You apply must not prevent recipients of the Adapted Material from complying with this Public License.

Section 4 – Sui Generis Database Rights.

Where the Licensed Rights include Sui Generis Database Rights that apply to Your use of the Licensed Material:

- for the avoidance of doubt, Section 2(a)(1) grants You the right to extract, reuse, reproduce, and Share all or a substantial portion of the contents of the database;
- if You include all or a substantial portion of the database contents in a database in which You have Sui Generis Database Rights, then the database in which You have Sui Generis Database Rights (but not its individual contents) is Adapted Material; and
- You must comply with the conditions in Section 3(a) if You Share all or a substantial portion of the contents of the database.

For the avoidance of doubt, this Section 4 supplements and does not replace Your obligations under this Public License where the Licensed Rights include other Copyright and Similar Rights.

Section 5 – Disclaimer of Warranties and Limitation of Liability.

- Unless otherwise separately undertaken by the Licensor, to the extent possible, the Licensor offers the Licensed Material as-is and as-available, and makes no representations or warranties of any kind concerning the Licensed Material, whether express, implied, statutory, or other. This includes, without limitation, warranties of title, merchantability, fitness for a particular purpose, non-infringement, absence of latent or other defects, accuracy, or the presence or absence of errors, whether or not known or discoverable. Where disclaimers of warranties are not allowed in full or in part, this disclaimer may not apply to You.
- To the extent possible, in no event will the Licensor be liable to You on any legal theory (including, without limitation, negligence) or otherwise for any direct, special, indirect, incidental, consequential, punitive, exemplary, or other losses, costs, expenses, or damages arising out of this Public License or use of the Licensed Material, even if the Licensor has been advised of the possibility of such losses, costs, expenses, or damages. Where a limitation of liability is not allowed in full or in part, this limitation may not apply to You.

- The disclaimer of warranties and limitation of liability provided above shall be interpreted in a manner that, to the extent possible, most closely approximates an absolute disclaimer and waiver of all liability.

Section 6 – Term and Termination.

- This Public License applies for the term of the Copyright and Similar Rights licensed here. However, if You fail to comply with this Public License, then Your rights under this Public License terminate automatically.
- Where Your right to use the Licensed Material has terminated under Section 6(a), it reinstates:
 - automatically as of the date the violation is cured, provided it is cured within 30 days of Your discovery of the violation; or
 - upon express reinstatement by the Licensor.

For the avoidance of doubt, this Section 6(b) does not affect any right the Licensor may have to seek remedies for Your violations of this Public License.

- For the avoidance of doubt, the Licensor may also offer the Licensed Material under separate terms or conditions or stop distributing the Licensed Material at any time; however, doing so will not terminate this Public License.
- Sections 1, 5, 6, 7, and 8 survive termination of this Public License.

Section 7 – Other Terms and Conditions.

- The Licensor shall not be bound by any additional or different terms or conditions communicated by You unless expressly agreed.
- Any arrangements, understandings, or agreements regarding the Licensed Material not stated herein are separate from and independent of the terms and conditions of this Public License.

Section 8 – Interpretation.

- For the avoidance of doubt, this Public License does not, and shall not be interpreted to, reduce, limit, restrict, or impose conditions on any use of the Licensed Material that could lawfully be made without permission under this Public License.

- To the extent possible, if any provision of this Public License is deemed unenforceable, it shall be automatically reformed to the minimum extent necessary to make it enforceable. If the provision cannot be reformed, it shall be severed from this Public License without affecting the enforceability of the remaining terms and conditions.
- No term or condition of this Public License will be waived and no failure to comply consented to unless expressly agreed to by the Licensor.
- Nothing in this Public License constitutes or may be interpreted as a limitation upon, or waiver of, any privileges and immunities that apply to the Licensor or You, including from the legal processes of any jurisdiction or authority.

License for LibYAML

Pulse Secure Virtual Traffic Manager contains code from LibYAML - a C library for parsing and emitting YAML. The following copyright notice applies:

Version: 0.2.1

License summary: MIT

Copyright:

Copyright (c) 2017-2019 Ingy döt Net

Copyright (c) 2006-2016 Kirill Simonov

Permission is hereby granted, free of charge, to any person obtaining a copy of this software and associated documentation files (the "Software"), to deal in the Software without restriction, including without limitation the rights to use, copy, modify, merge, publish, distribute, sublicense, and/or sell copies of the Software, and to permit persons to whom the Software is furnished to do so, subject to the following conditions:

The above copyright notice and this permission notice shall be included in all copies or substantial portions of the Software.

THE SOFTWARE IS PROVIDED "AS IS", WITHOUT WARRANTY OF ANY KIND, EXPRESS OR IMPLIED, INCLUDING BUT NOT LIMITED TO THE WARRANTIES OF MERCHANTABILITY, FITNESS FOR A PARTICULAR PURPOSE AND NONINFRINGEMENT. IN NO EVENT SHALL THE AUTHORS OR COPYRIGHT HOLDERS BE LIABLE FOR ANY CLAIM, DAMAGES OR OTHER LIABILITY, WHETHER IN AN ACTION OF CONTRACT, TORT OR OTHERWISE, ARISING FROM, OUT OF OR IN CONNECTION WITH THE SOFTWARE OR THE USE OR OTHER DEALINGS IN THE SOFTWARE.

License for giflib

Pulse Secure Virtual Traffic Manager contains code from giflib - a library for reading and writing gif images. The following copyright notice applies:

Version: 5.2.1

License summary: MIT

Copyright:

The GIFLIB distribution is Copyright (c) 1997 Eric S. Raymond

Permission is hereby granted, free of charge, to any person obtaining a copy of this software and associated documentation files (the "Software"), to deal in the Software without restriction, including without limitation the rights to use, copy, modify, merge, publish, distribute, sublicense, and/or sell copies of the Software, and to permit persons to whom the Software is furnished to do so, subject to the following conditions:

The above copyright notice and this permission notice shall be included in all copies or substantial portions of the Software.

THE SOFTWARE IS PROVIDED "AS IS", WITHOUT WARRANTY OF ANY KIND, EXPRESS OR IMPLIED, INCLUDING BUT NOT LIMITED TO THE WARRANTIES OF MERCHANTABILITY, FITNESS FOR A PARTICULAR PURPOSE AND NONINFRINGEMENT. IN NO EVENT SHALL THE AUTHORS OR COPYRIGHT HOLDERS BE LIABLE FOR ANY CLAIM, DAMAGES OR OTHER LIABILITY, WHETHER IN AN ACTION OF CONTRACT, TORT OR OTHERWISE, ARISING FROM, OUT OF OR IN CONNECTION WITH THE SOFTWARE OR THE USE OR OTHER DEALINGS IN THE SOFTWARE.

License for Gorilla WebSocket

Pulse Secure Virtual Traffic Manager contains code from Gorilla WebSocket - a WebSocket implementation for GoLang. The following copyright notice applies:

Version: 1.4.0

License summary: BSD 2-Clause

Copyright:

Copyright (c) 2013 The Gorilla WebSocket Authors. All rights reserved.

Redistribution and use in source and binary forms, with or without modification, are permitted provided that the following conditions are met:

- Redistributions of source code must retain the above copyright notice, this list of conditions and the following disclaimer.
- Redistributions in binary form must reproduce the above copyright notice, this list of conditions and the following disclaimer in the documentation and/or other materials provided with the distribution.

THIS SOFTWARE IS PROVIDED BY THE COPYRIGHT HOLDERS AND CONTRIBUTORS "AS IS" AND ANY EXPRESS OR IMPLIED WARRANTIES, INCLUDING, BUT NOT LIMITED TO, THE IMPLIED OF MERCHANTABILITY AND FITNESS FOR A PARTICULAR PURPOSE ARE DISCLAIMED. IN NO EVENT SHALL THE COPYRIGHT HOLDER OR CONTRIBUTORS BE LIABLE FOR ANY DIRECT, INDIRECT, INCIDENTAL, SPECIAL, EXEMPLARY, OR CONSEQUENTIAL DAMAGES (INCLUDING, BUT NOT LIMITED TO, PROCUREMENT OF SUBSTITUTE GOODS OR SERVICES; LOSS OF USE, DATA, OR PROFITS; OR BUSINESS INTERRUPTION) HOWEVER CAUSED AND ON ANY THEORY OF LIABILITY, WHETHER IN CONTRACT, STRICT LIABILITY, OR TORT (INCLUDING NEGLIGENCE OR OTHERWISE) ARISING IN ANY WAY OUT OF THE USE OF THIS SOFTWARE, EVEN IF ADVISED OF THE POSSIBILITY OF SUCH DAMAGE.

License for Go

Pulse Secure Virtual Traffic Manager contains code using Go - an open source programming language. The following copyright notice applies:

Version: 1.15.7

License summary: BSD 3-Clause

Copyright:

Copyright (c) 2009 The Go Authors. All rights reserved.

Redistribution and use in source and binary forms, with or without modification, are permitted provided that the following conditions are met:

- Redistributions of source code must retain the above copyright notice, this list of conditions and the following disclaimer.
- Redistributions in binary form must reproduce the above copyright notice, this list of conditions and the following disclaimer in the documentation and/or other materials provided with the distribution.

- Neither the name of Google Inc. nor the names of its contributors may be used to endorse or promote products derived from this software without specific prior written permission.

THIS SOFTWARE IS PROVIDED BY THE COPYRIGHT HOLDERS AND CONTRIBUTORS "AS IS" AND ANY EXPRESS OR IMPLIED WARRANTIES, INCLUDING, BUT NOT LIMITED TO, THE IMPLIED WARRANTIES OF MERCHANTABILITY AND FITNESS FOR A PARTICULAR PURPOSE ARE DISCLAIMED. IN NO EVENT SHALL THE COPYRIGHT OWNER OR CONTRIBUTORS BE LIABLE FOR ANY DIRECT, INDIRECT, INCIDENTAL, SPECIAL, EXEMPLARY, OR CONSEQUENTIAL DAMAGES (INCLUDING, BUT NOT LIMITED TO, PROCUREMENT OF SUBSTITUTE GOODS OR SERVICES; LOSS OF USE, DATA, OR PROFITS; OR BUSINESS INTERRUPTION) HOWEVER CAUSED AND ON ANY THEORY OF LIABILITY, WHETHER IN CONTRACT, STRICT LIABILITY, OR TORT (INCLUDING NEGLIGENCE OR OTHERWISE) ARISING IN ANY WAY OUT OF THE USE OF THIS SOFTWARE, EVEN IF ADVISED OF THE POSSIBILITY OF SUCH DAMAGE.

Open Source Software Notice

This product includes software originating from third parties that are subject to one or more of the following:

- The GNU Library/Lesser General Public License (LGPL)
- The GNU General Public License (GPL)
- The Berkeley Software Distribution (BSD) License
- The OSI Artistic License
- Various GPL/BSD-like Distribution Licenses

All applicable third party software packages and accompanying licenses are listed in this document and in the Pulse Secure Virtual Traffic Manager: Appliance License Acknowledgements, available from the Traffic Manager product pages on the Ivanti Web site.

Ivanti, Inc. offers to provide a complete copy of the source code for the software under said licenses on a CD-ROM, for a charge covering the cost of performing such distribution, such as the cost of media, shipping, and handling, upon written request to Ivanti, Inc. at the following address:

Source Code Requests VTM-APPLIANCE (GPL)

Ivanti, Inc.

The Jeffreys Building

Cowley Road

Cambridge

CB4 0DS

United Kingdom

This offer is valid for a period of three (3) years from the date of the distribution of this product by Ivanti, Inc.. Please refer to the exact terms of the appropriate license regarding your rights.